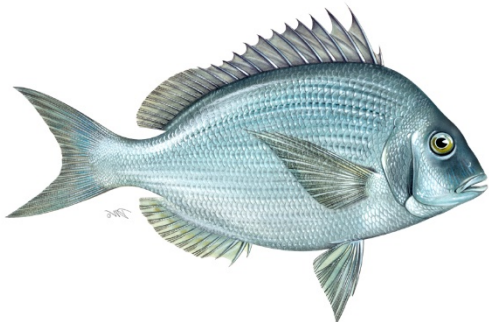
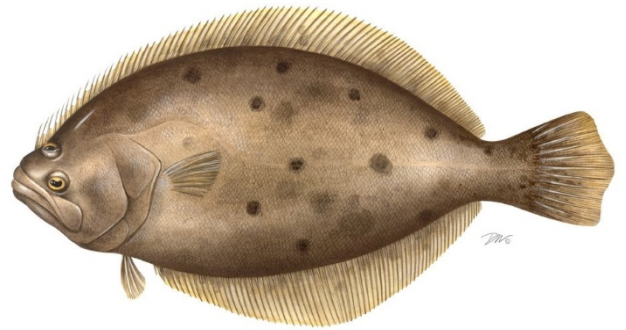


***Atlantic States Marine Fisheries Commission***

**Draft Amendment to the Interstate Fishery  
Management Plan for Summer Flounder, Scup, and  
Black Sea Bass for Public Comment**  
***Summer Flounder, Scup, and Black Sea Bass  
Commercial/Recreational Allocation Amendment***



December 2020



***Sustainable and Cooperative Management of Atlantic Coastal Fisheries***

# DRAFT DOCUMENT FOR PUBLIC COMMENT

Draft Amendment to the Interstate Fishery Management Plan for  
Summer Flounder, Scup, and Black Sea Bass

Prepared by

Atlantic States Marine Fisheries Commission and  
Mid-Atlantic Fishery Management Council's Fishery Management Action Team

Fishery Management Action Team Members:

Gregory Ardini, NOAA Fisheries

Julia Beaty, Mid-Atlantic Fishery Management Council

Dustin Colson Leaning, Atlantic States Marine Fisheries Commission

Karson Coutre, Mid-Atlantic Fishery Management Council

Kiley Dancy, Mid-Atlantic Fishery Management Council

Marianne Ferguson, NOAA Fisheries

Emily Keiley, NOAA Fisheries

Savannah Lewis, Atlantic States Marine Fisheries Commission

Gary Shepherd, NOAA Fisheries

Mark Terceiro, Northeast Fisheries Science Center

This is a report of the Atlantic States Marine Fisheries Commission pursuant to U.S. Department of Commerce, National Oceanic and Atmospheric Administration Award No. NA15NMF4740069.



## DRAFT AMENDMENT FOR PUBLIC COMMENT

### Public Comment Process and Proposed Timeline

The Atlantic States Marine Fisheries Commission (Commission) and Mid-Atlantic Fishery Management Council (Council) seek your input on the following Draft Amendment to the Summer Flounder, Scup, and Black Sea Bass Fishery Management Plan. In particular, sections 4.1 – 4.4 introduce alternative management approaches that are under consideration.

You are encouraged to submit comments regarding this document during the public comment period. Comments must be received by **5:00 P.M. (EST) on March 16<sup>th</sup>**. Regardless of when they were sent, comments received after that time will not be included in the official record. The Commission and Council will consider public comment on this document before finalizing the amendment.

You may submit public comment by attending a public hearing or mailing, faxing, or emailing written comments to the address below. Comments can also be referred to your state's members on the Summer Flounder, Scup, and Black Sea Bass Management Board or Summer Flounder, Scup, and Black Sea Bass Advisory Panel; however, unless those comments are also submitted as instructed below they will not be considered as part of the official public comment record.

Written comments may be sent by any of the following methods:

1. **Online** at <https://www.mafmc.org/comments/sfsbsb-allocation-amendment>
2. **Email** to the following addresses: [kdancy@mafmc.org](mailto:kdancy@mafmc.org)
3. **Mail or Fax** to:

Chris Moore, Ph.D, Executive Director  
Mid-Atlantic Fishery Management Council  
North State Street, Suite 201  
Dover, DE 19901  
FAX: 302.674.5399

If your organization is planning to release an action alert in response to this Draft Amendment, or if you have questions, please contact either Dustin Colson Leaning (email: [dleaning@asmfc.org](mailto:dleaning@asmfc.org); phone: 703.842.0740) or Kiley Dancy (email: [kdancy@mafmc.org](mailto:kdancy@mafmc.org); phone at 302.526.5257)

DRAFT AMENDMENT FOR PUBLIC COMMENT

The timeline for completion of the Summer Flounder, Scup, and Black Sea Bass Commercial/Recreational Allocation Amendment is as follows:

	Dec 2019	Feb–Mar 2020	May 2020	May–Nov 2020	Dec 2020	January – February 2021	Spring 2021
Approval of Draft PID by Board and Council	X						
Public review and comment on PID		X					
Board and Council review of public comment; Board direction on what to include in the Draft Amendment			X				
Preparation of Draft Amendment				X			
Review and approval of Draft Amendment by Board and Council for public comment					X		
Public review and comment on Draft Amendment <i>Current Step</i>						X	
Board review of public comment on Draft Amendment							X
Review and approval of the final Amendment by the Council, Board, Policy Board, and Commission							X

## TABLE OF CONTENTS

1.0	INTRODUCTION .....	1
1.1	Background Information .....	1
1.2	Description of the Resource .....	5
1.3	Description of the Fisheries .....	13
1.4	Habitat Considerations .....	52
1.5	Impacts to the Fishery Management Program .....	65
2.0	GOALS AND OBJECTIVES .....	66
2.1	History of Management .....	66
2.2	Joint Management .....	72
2.3	Management Unit .....	73
2.4	Purpose and Need for Action .....	73
2.5	Goals and Objectives .....	74
3.0	MONITORING PROGRAM SPECIFICATION .....	75
3.1	Summary of Monitoring Programs .....	75
3.2	Social and Economic Collection Programs .....	76
3.3	Biological Data Collection Programs .....	76
4.0	MANAGEMENT PROGRAM .....	77
4.1	Commercial and Recreational Allocation Alternatives .....	77
4.2	Quota Transfers .....	83
4.3	Framework/addendum Provision Alternatives .....	85
4.4	Impacts of the Fishery Management Program .....	86
4.5	Alternative State Management Regimes .....	117
4.6	Adaptive Management .....	118
4.7	Emergency Procedures .....	120
4.8	Management Institutions .....	120
4.9	Recommendations to the Secretary of Commerce for Complementary Actions in Federal Jurisdictions .....	122
4.10	Cooperation with Other Management Institutions .....	122
5.0	COMPLIANCE .....	122
5.1	Mandatory Compliance Elements for States .....	122
5.2	Compliance Schedule .....	123
5.3	Compliance Report Content .....	124

DRAFT AMENDMENT FOR PUBLIC COMMENT

5.4 Procedures for Determining Compliance ..... 127

5.5 Analysis of Enforceability of Proposed Measures ..... 127

6.0 MANAGEMENT AND RESEARCH NEEDS..... 127

6.1 Summer Flounder Management and Research Needs..... 128

6.2 Scup Management and Research Needs ..... 129

6.3 Black Sea Bass Management and Research Needs..... 130

7.0 REFERENCES ..... 132

APPENDIX I: Supplemental Information on Basis for Allocation Alternatives..... 136

APPENDIX II: Example Quotas and RHLs Under Each Allocation Alternative ..... 142

APPENDIX III: Acronyms and Abbreviations ..... 146

## **1.0 INTRODUCTION**

The summer flounder (*Paralichthys dentatus*), scup (*Stenotomus chrysops*) and black sea bass (*Centropristis striata*) fisheries are managed under the Summer Flounder, Scup and Black Sea Bass Fishery Management Plan (FMP) that was prepared cooperatively by the Mid-Atlantic Fishery Management Council (Council) and the Atlantic States Marine Fisheries Commission (ASMFC or Commission). The Commission, under the authority of the Atlantic Coastal Fisheries Cooperative Management Act, is responsible for managing summer flounder, scup, and black sea bass in state waters (0-3 miles). The Council develops regulations for federal waters (3-200 nautical miles from shore). NOAA Fisheries is the federal implementation and enforcement agency.

### **1.1 BACKGROUND INFORMATION**

Revised recreational catch and harvest estimates, released in 2018, show that recreational catch and harvest of summer flounder, scup, and black sea bass are much higher than previously estimated and have resulted in significant changes to stock biomass estimates and resulting catch limits for these three species. As described in more detail below, these changes have consequential management impacts due to fixed commercial and recreational allocations of catch or landings for each species. In light of these impacts, at a joint meeting of the Board and Council in October 2019, the Summer Flounder, Scup, and Black Sea Bass Management Board (Board) and Council initiated an amendment to consider modifications to the commercial/recreational sector allocations for summer flounder, scup, and black sea bass. The Board and Council approved the Scoping and Public Information Document for public comment in December 2019. Public comment was received and eleven scoping hearings were held from Massachusetts through North Carolina between February and March, 2020. The hearings were attended by approximately 280 people, and 207 individuals and organizations provided comments in person or in writing.

Based on the summary of public comments, comments from the Advisory Panels (APs), and recommendations from the Fishery Management Action Team (FMAT), the Board and Council supported exploration of a variety of approaches including status quo, updating existing base years with revised data, separate allocations for the for-hire and private sectors of the recreational fishery, a 'harvest control rule' approach, dynamic allocations, and allocation transfers between sectors. Due to concerns about recreational data, the Board and Council also supported the development of draft alternatives to address recreational accountability and catch counting.

At the June and August 2020 joint meetings, the Board and Council determined that the 'harvest control rule', recreational accountability measures, recreational catch accounting, and recreational for-hire sector separation alternatives should be removed from this action and instead considered for inclusion in the recreational reform initiative.

## DRAFT AMENDMENT FOR PUBLIC COMMENT

In August 2020, the Board and Council identified the following priority issues for further development within this action including:

1. Summer flounder recreational/commercial allocation *Section 4.1.1*
2. Scup recreational/commercial allocation *Section 4.1.2*
3. Black sea bass recreational/commercial allocation *Section 4.1.3*
4. Allocation change phase-in *Section 4.1.4*
5. Quota transfers *Section 4.2*
6. Adaptive Management Provisions *Section 4.3*

### **1.1.1 Statement of Problem**

#### ***1.1.1.1 Summer Flounder, Scup, and Black Sea Bass Commercial/Recreational Allocation***

The commercial and recreational allocations for all three species are currently based on historical proportions of landings (for summer flounder and black sea bass) or catch (for scup) from each sector. Recent changes in how recreational catch is estimated have resulted in a discrepancy between the current levels of estimated recreational harvest and the allocations for summer flounder, scup, and black sea bass to the recreational sector.

Recreational catch and harvest data are estimated by the Marine Recreational Information Program (MRIP). In July 2018, MRIP released revised time series of catch and harvest estimates based on adjustments to its angler intercept methodology, which is used to estimate catch rates, and its effort estimation methodology, namely, a transition from a telephone-based effort survey to a mail-based effort survey for the private/rental boat and shore-based fishing modes<sup>1</sup>. These revisions collectively resulted in much higher recreational catch estimates compared to previous estimates, affecting the entire time series of data going back to 1981.

The revised MRIP estimates were incorporated into the stock assessment for summer flounder in 2018 and for scup and black sea bass in 2019. This impacted the estimated stock biomass and resulting catch limits for these species. In general, because the revised MRIP data showed that more fish were caught than previously thought, the stock assessment models estimated that there must have been more fish available to catch, which in turn impacted the biomass estimates derived from the stock assessments. However, for each species, the revised MRIP data were one of many factors that impacted the stock assessments and the resulting catch limits. Other factors such as the addition of data on recent recruitment also impacted the assessment model results.

- For summer flounder, the revised MRIP estimates were 30% higher on average compared to the previous estimates for 1981-2017. The differences between the previous and revised estimates tended to be greater in more recent years compared to earlier years. Increased recreational catch resulted in increased estimates of stock size compared to past assessments. The higher biomass projections resulted in a 49% increase in the commercial quota and recreational harvest limit (RHL) for 2019.

---

<sup>1</sup> For-hire effort continues to be assessed through a telephone survey of known for-hire operators. More information on how MRIP collects data from the recreational fishery is available at: <https://www.fisheries.noaa.gov/recreational-fishing-data/types-recreational-fishing-surveys>.



## DRAFT AMENDMENT FOR PUBLIC COMMENT

Expected recreational harvest in the revised MRIP currency was close to the revised RHL; therefore, recreational measures could not be liberalized in 2019 despite the 49% increase in the RHL.

- For scup, the revised MRIP recreational catch estimates were, on average, 18% higher than the previous estimates for 1981-2017. The differences between the previous and revised estimates tended to be greater in more recent years compared to earlier years. The MRIP data have a lesser impact in the scup stock assessment model, with the 2019 operational stock assessment showing minor increases in biomass estimates compared to the 2015 assessment. Due to below-average recruitment in recent years, the scup catch and landings limits for both commercial and recreational sectors decreased slightly in response to the results of the 2019 operational stock assessment.
- For black sea bass, the revised MRIP recreational catch estimates increased the 1981-2017 total catch by an average of 73%, ranging from +9% in 1995 to +161% in 2017. As with summer flounder and scup, the differences between the previous and revised estimates tended to be greater in more recent years compared to earlier years. These increased catch estimates, in addition to other factors such as an above average 2015 year class, contributed to a notable scaling up of the spawning stock biomass estimates from the previous assessment. As a result, the 2020 black sea bass commercial quota and RHL both increased by 59% compared to 2019. Although this led to an increase in the RHL, recent harvest under the new MRIP data was higher than the 2020 RHL, therefore, recreational management measures could not be liberalized in response to this increased RHL.

Some changes have also been made to commercial catch data since the allocations were established. For example, the commercial scup discard estimates throughout the time series were revised through the 2015 scup stock assessment. For the 1988-1992 allocation base years, the current estimates of scup commercial catch are, on average, 8% lower than estimates used to set the allocations under Amendment 8.

The commercial and recreational data revisions not only impact the catch estimates, but also significantly affected our understanding of the population levels for all three fish stocks. This has management implications due to the fixed commercial/recreational allocation percentages defined in the FMP for all three species. These allocation percentages do not reflect the current understanding of the recent and historic proportions of catch and landings from the two sectors. These allocation percentages are defined in the Council and Commission FMPs; therefore, they can only be modified through an FMP amendment. This Amendment will consider whether the allocations are still appropriate and meeting the objectives of the FMP, as well as other potential changes related to how the allocations are managed, as described in Sections 4.2 and 4.3.

### ***1.1.1.2 Allocation Change Phase-In***

Changes in allocation percentages for each of the three species can be implemented immediately, but due to the potential large shift in allocation, the Council and Board are

considering phasing in any changes over 2, 3, or 5 years. The Council and Board agreed 5 years is a reasonable maximum phase-in time frame, as longer transition periods may not adequately address the management issue an allocation change is attempting to address. The choice of whether to use a phase-in approach, and the length of the phase-in period, may depend on the magnitude of allocation change proposed. A phase-in period may not be desired if the overall allocation change is relatively small. Larger allocation changes may be less disruptive to fishing communities if they are phased in over several years. The phase-in alternatives could apply to any of the three species. The Council and Board may choose to apply different phase-in alternatives (including no phase-in) to each species if desired.

#### ***1.1.1.3 Quota Transfer Provision***

Quota transfers are a management tool that offer the potential for increased fishing opportunities in the commercial or recreational sectors for summer flounder, scup, and black sea bass. Currently, the FMP does not allow for transfers of quota to occur between the commercial and recreational sectors. A transfer of quota between the commercial and recreational sectors could be considered annually under the specifications setting process, as well as a cap on the maximum transfer amount. This process would allow for an expedient response to a potential future pressing need for increased fishing opportunities for either the commercial or recreational fisheries.

#### ***1.1.1.4 Adaptive Management Provision***

The Board has the ability to add all management approaches considered through this Amendment to the list of measures subject to change through adaptive management (i.e., addenda). Addenda are modifications to the FMPs that are typically (though not always) more efficient than an amendment. While amendments may take several years to complete and may be more complex, addenda can often be completed in 5-8 months. Both types of management actions include multiple opportunities for public input during Board meetings and public comment periods; however, scoping and public hearings are required for amendments, but are optional for addenda. Addenda can only modify existing measures and/or those that have been previously considered in an FMP amendment.

### **1.1.2 Benefits of Implementation**

This Amendment is designed to address the issue of allocation between the commercial and recreational sectors for summer flounder, scup, and black sea bass as described above. Additionally, this Amendment proposes processes by which the Board and Council may transfer quota between sectors or adjust allocations in the future should the need arise. In combination, these management approaches aim to provide fair and equitable access to all fishery participants.

#### ***1.1.2.1 Ecological Benefits***

Throughout their ranges, summer flounder, scup, and black sea bass occupy important roles in the coastal marine food chain. All three species are benthic feeders that prey upon lower trophic level species while also providing sustenance to commercially viable predator species such as monkfish, spiny dogfish, and king mackerel. Implementation of this action will help the

Board and Council effectively manage these species under catch limits based on the best scientific information available in order to maintain healthy stock conditions for all three species.

**1.1.2.2 Social and Economic Benefits**

Summer flounder, scup, and black sea bass support valuable and culturally significant commercial and recreational fisheries along the Atlantic coast. Addressing the revised MRIP information, recent fishing trends, and the needs of the commercial and recreational fisheries to inform the allocation between the two sectors may enhance social and economic benefits by increasing economic returns and increasing access to the resources. This in turn could increase resilience in fishery-dependent communities along the Atlantic coast.

**1.2 DESCRIPTION OF THE RESOURCE**

**1.2.1 Summer Flounder**

Summer flounder are a demersal flatfish found in pelagic waters, demersal waters, saltmarsh creeks, seagrass beds, mudflats, and open bay areas. Spawning occurs during the fall and winter over the open ocean over the continental shelf. Larvae and postlarvae are transported toward coastal areas by prevailing water currents, entering coastal and estuarine nursery areas. Development of post larvae and juveniles occurs primarily within bays and estuarine areas. Adult summer flounder exhibit strong seasonal inshore-offshore movements, normally inhabiting shallow coastal and estuarine waters during the warmer months of the year and remaining offshore during the colder months. Most fish are sexually mature by age 2. Summer flounder exhibit sexual dimorphism by size; most of the largest fish are females. Females can attain lengths over 90 cm (36 in) and weights up to 11.8 kg (26 lbs.; NEFSC 2017). Recent NEFSC trawl survey data indicate that while female summer flounder grow faster (reaching a larger size at the same age), the sexes attain about the same maximum age (currently age 15 at 56 cm for males, and age 14 at 65 cm for females). Unsexed commercial fishery samples currently indicate a maximum age of 17 for an 85 cm fish (M. Terceiro, personal communication, January 2017).

Summer flounder are opportunistic feeders; their prey includes a variety of fish and crustaceans. While the predators of adult summer flounder are not fully documented, larger predators such as large sharks, rays, and monkfish probably include summer flounder in their diets (Packer et al. 1999).

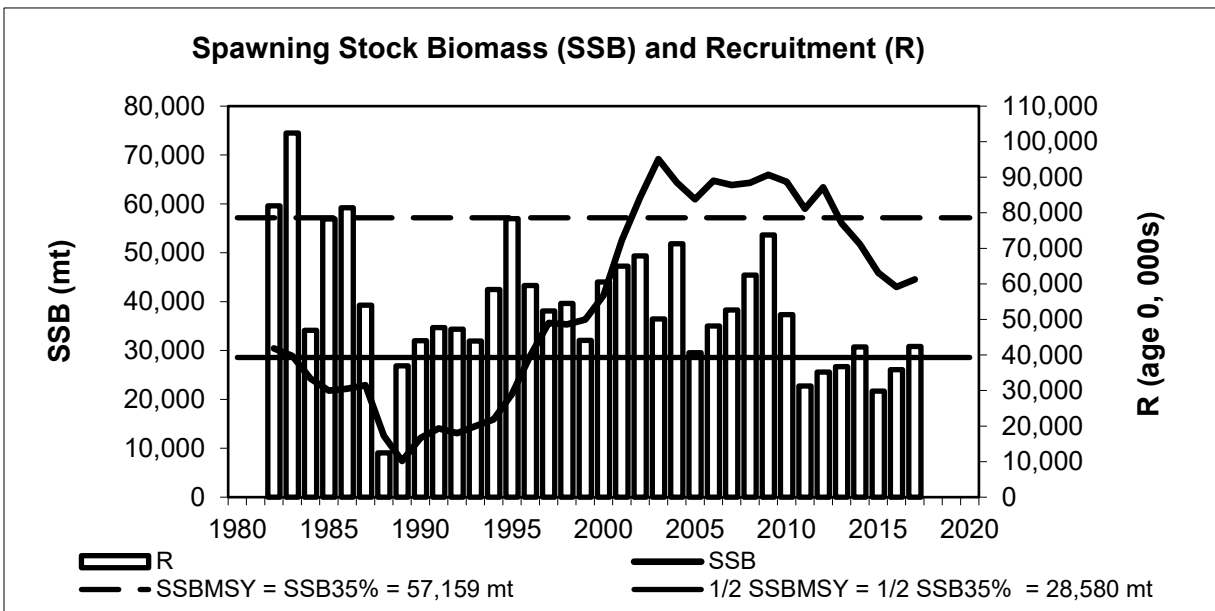
The recent benchmark stock assessment was developed through the 66<sup>th</sup> SAW process, and peer reviewed at the 66<sup>th</sup> SARC from November 27-30, 2018 (NEFSC 2019a). The assessment incorporated the revised time series of recreational catch from MRIP, which is 30% higher on average compared to the previous summer flounder estimates for 1981-2017. The MRIP estimate revisions account for changes in both the angler intercept survey and recreational effort survey methodologies. While fishing mortality rates were not strongly affected by incorporating these revisions, increased recreational catch resulted in increased estimates of stock size compared to past assessments.

The biological reference points for summer flounder, as revised through the SAW/SARC 66 process, include a fishing mortality threshold of  $F_{MSY} = F_{35\%}$  (as the  $F_{MSY}$  proxy) = 0.448, and a biomass reference point of  $SSB_{MSY} = SSB_{35\%}$  (as the  $SSB_{MSY}$  proxy) = 126.01 million lb = 57,159 mt. The minimum stock size threshold ( $1/2 SSB_{MSY}$ ), is estimated to be 63.01 million lb (28,580 mt; Figure 1).

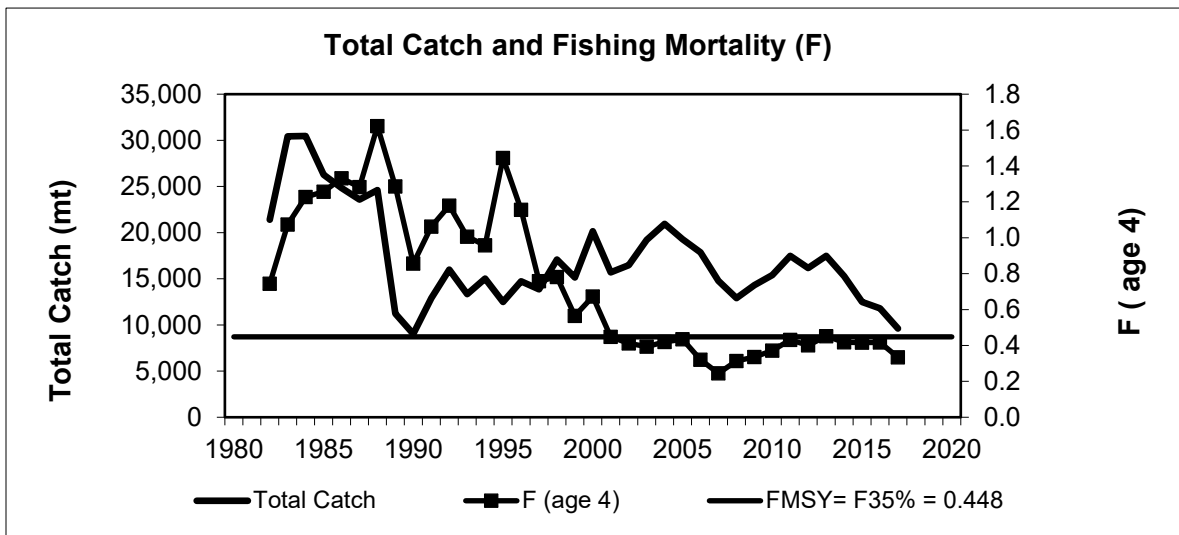
Assessment results indicate that the summer flounder stock was not overfished and overfishing was not occurring in 2017. Fishing mortality on the fully selected age 4 fish ranged between 0.744 and 1.622 during 1982-1996 and then decreased to 0.245 in 2007. Since 2007 the fishing mortality rate (F) has increased, and in 2017 was estimated at 0.334, below the SAW 66  $F_{MSY}$  proxy =  $F_{35\%} = 0.448$  (Figure 2). The 90% confidence interval for F in 2017 was 0.276 to 0.380.

SSB decreased from 67.13 million lb (30,451 mt) in 1982 to 16.33 million lb (7,408 mt) in 1989, and then increased to 152.46 million lb (69,153 mt) in 2003. SSB has decreased since 2003 and was estimated to be 98.22 million lb (44,552 mt) in 2017, about 78% of  $SSB_{MSY} = 126.01$  million lb (57,159 mt), and 56% above the  $1/2 SSB_{MSY}$  proxy =  $1/2 SSB_{35\%} = 63.01$  million lb (28,580 mt; Figure 1). The 90% confidence interval for SSB in 2017 was 39,195 to 50,935 mt.

Recruitment of juvenile summer flounder to the fishery has been below average since about 2011, although the driving factors behind this trend have not been identified. Bottom trawl survey data also indicate a recent trend of decreasing length and weight at age, which implies slower growth and delayed maturity. These factors affected the change in the biological reference points used to determine stock status.



**Figure 1. Summer flounder spawning stock biomass (SSB; solid line) and recruitment at age 0 (R; vertical bars) 1980-2017. The horizontal dashed line is the 2018 SAW66 recommended target biomass reference point proxy,  $SSB_{MSY} = SSB_{35\%} = 57,159$  mt. The horizontal solid line is the 2018 SAW66 recommended threshold biomass reference point proxy  $1/2 SSB_{MSY} = 1/2 SSB_{35\%} = 28,580$  mt. Source: NEFSC 2019a.**



**Figure 2. Total fishery catch (mt; solid line) and fully-recruited fishing mortality (F, peak at age 4; squares) of summer flounder. The horizontal solid line is the 2018 SAW66 recommended fishing mortality reference point proxy FMSY = F35% = 0.448. Source: NEFSC 2019a.**

### 1.2.2 Scup

Scup are a schooling, demersal (i.e., bottom-dwelling) species found in a variety of habitats in the Mid-Atlantic. Scup essential fish habitat (EFH) includes demersal waters, areas with sandy or muddy bottoms, mussel beds, and sea grass beds primarily from the Gulf of Maine through Cape Hatteras, North Carolina. Scup undertake extensive seasonal migrations between coastal and offshore waters. They are mostly found in estuaries and coastal waters during the spring and summer. Larger individuals tend to arrive in inshore areas in the spring before smaller individuals. They move offshore and to the south, to outer continental shelf waters south of New Jersey in the fall and winter (Steimle et al. 1999, NEFSC 2015).

About 50% of scup are sexually mature at two years of age and about 17 cm (about 7 inches) total length. Nearly all scup older than three years of age are sexually mature. Scup reach a maximum age of at least 14 years. They may live as long as 20 years; however, few scup older than 7 years are caught in the Mid-Atlantic (Steimle et al. 1999, NEFSC 2015).

Adult scup are benthic feeders. They consume a variety of prey, including small crustaceans (including zooplankton), polychaetes, mollusks, small squid, vegetable detritus, insect larvae, hydroids, sand dollars, and small fish. The NEFSC’s food habits database lists several predators of scup, including several shark species, skates, silver hake, bluefish, summer flounder, black sea bass, weakfish, lizardfish, king mackerel, and monkfish (Steimle et al. 1999).

A scup operational stock assessment was peer reviewed and accepted in August 2019. This assessment retained the model structure of the previous benchmark stock assessment, completed in 2015, and incorporated fishery catch and fishery-independent survey data through 2018, including revised recreational data provided by MRIP for 1989-2018 (NEFSC 2019b).

The assessment found that the scup stock was not overfished and overfishing was not occurring in 2018. Updated proxy biological reference points from the 2019 operational stock assessment include a fishing mortality reference point of  $F_{MSY}$  proxy =  $F_{40\%}$  = 0.215, a biomass reference point of  $SSB_{MSY}$  proxy =  $SSB_{40\%}$  = 207.279 million pounds (94,020 mt), and a minimum biomass threshold of  $\frac{1}{2} SSB_{MSY}$  proxy =  $\frac{1}{2} SSB_{40\%}$  = 103.639 million pounds (47,010 mt, NEFSC 2019b). Spawning stock biomass (SSB) was estimated to be about 411 million pounds (186,578 mt), about 2 times the  $SSB_{MSY}$  proxy reference point (i.e.  $SSB_{40\%}$ ) of 207 million pounds (94,020 mt, Figure 3). Fishing mortality on fully selected age 3 scup was 0.158, about 73% of the  $F_{MSY}$  proxy reference point ( $F_{40\%}$ ) of 0.215 (Figure 4). The 2015 year class is estimated to be the largest in the time series at 326 million fish, while the 2016-2018 year classes are estimated to be below average at 112 million fish, 93 million fish and 83 million fish, respectively (Figure 3, NEFSC 2019b).

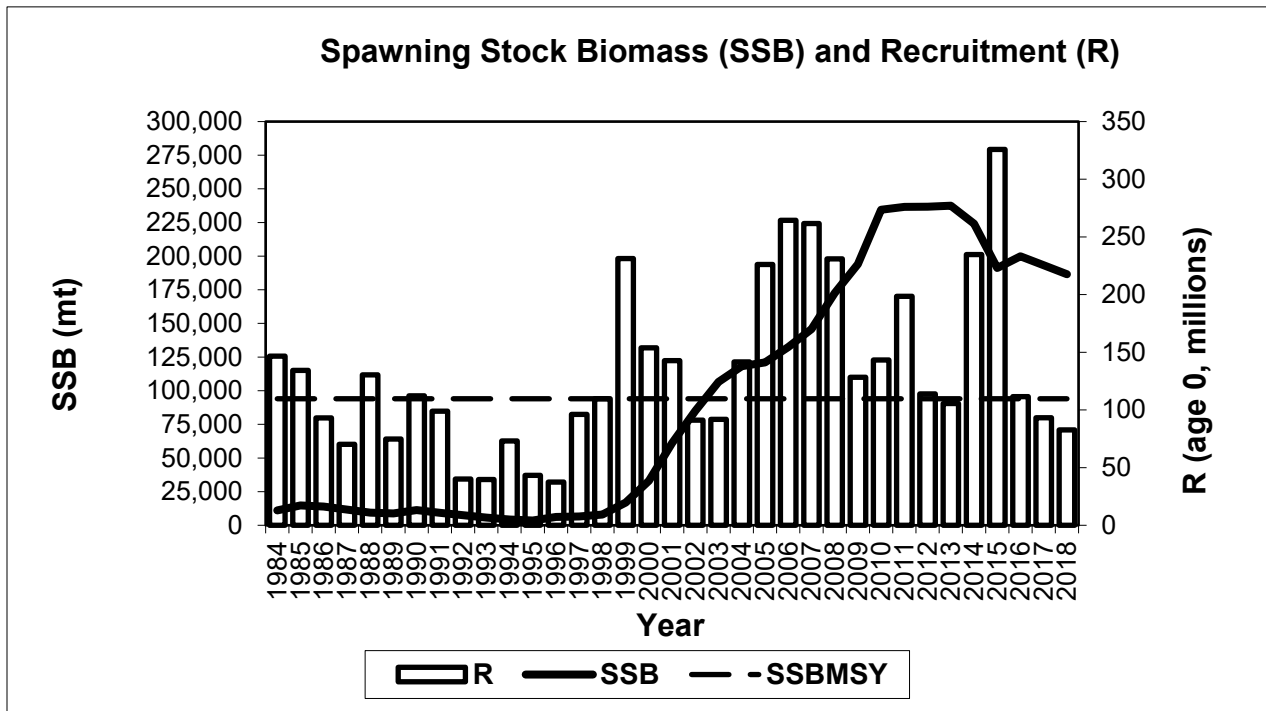


Figure 3. Scup SSB and recruitment at age 0, 1984-2018 from the 2019 operational stock assessment (NEFSC 2019b).

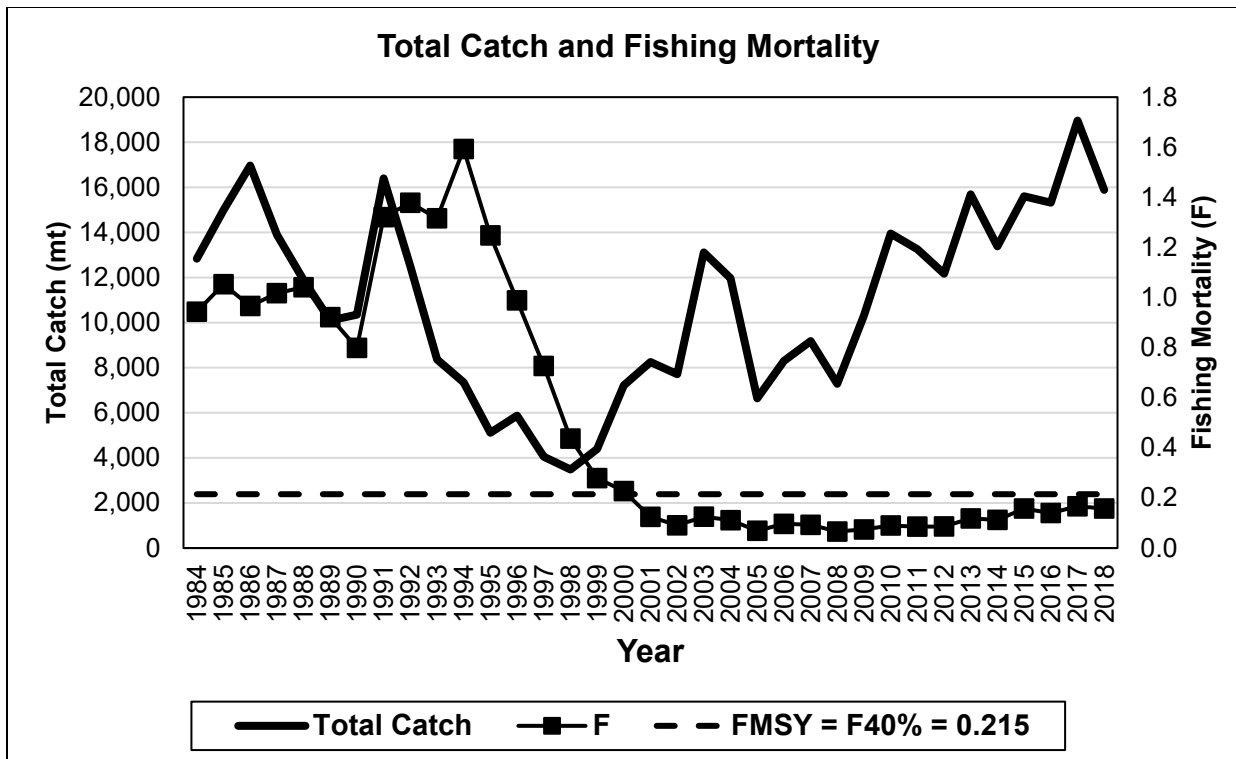


Figure 4. Scup total catch and fishing mortality, 1984-2018 from the 2019 operational stock assessment (NEFSC 2019b).

### 1.2.3 Black Sea Bass

Black sea bass are distributed from the Gulf of Maine through the Gulf of Mexico. Genetic studies have identified three stocks within that range. The boundaries of the northern stock are from the Gulf of Maine to Cape Hatteras, North Carolina. This stock is the focus of the black sea bass sections of this document. The stocks in the South Atlantic and Gulf of Mexico are not managed by the Commission and Mid-Atlantic Council.

Essential fish habitat for black sea bass consists of pelagic waters, structured habitat, rough bottom, shellfish, sand, and shell. Adult and juvenile black sea bass are mostly found on the continental shelf while young of the year (i.e., fish less than one year old) are primarily found in estuaries. Black sea bass migrate to offshore wintering areas starting in the fall to areas along the shelf edge, and can migrate as far south as the shelf edge off of Virginia. Most return to northern inshore areas by May, showing strong site fidelity during the summer. Adults prefer to be near structures such as rocky reefs, coral patches, cobble and rock fields, mussel beds, and shipwrecks. Black sea bass in the mid-Atlantic spawn between April and October in nearshore continental shelf areas at depths of 20-50 meters. (Drohan et al. 2007, NEFSC 2017).

Juvenile and adult black sea bass mostly feed on crustaceans, small fish, and squid. The NEFSC food habits database lists spiny dogfish, Atlantic angel shark, skates, spotted hake, summer flounder, windowpane flounder, and monkfish as predators of black sea bass (Drohan et al. 2007).

## DRAFT AMENDMENT FOR PUBLIC COMMENT

Black sea bass are protogynous hermaphrodites, meaning they are born female and some later transition to males around 2-5 years of age. Male black sea bass are either of the dominant or subordinate type. Dominant males are larger than subordinate males and develop a bright blue nuchal hump during the spawning season. About 25% of black sea bass are male at 15 cm (about 6 inches), with increasing proportions of males at larger sizes until about 50 cm, when about 70-80% of black sea bass are male. Results from a simulation model highlight the importance of subordinate males in the spawning success of this species. This increases the resiliency of the population to exploitation compared to other species with a more typical protogynous life history. About half of black sea bass are sexually mature by 2 years of age and 21 cm (about 8 inches) in length. Black sea bass reach a maximum size of about 60 cm (about 24 inches) and a maximum age of about 12 years (NEFSC 2017, Blaylock and Shepherd 2016).

A black sea bass operational stock assessment was peer reviewed and accepted in August 2019. This assessment retained the model structure of the previous benchmark stock assessment, completed in 2016 (NEFSC 2017), and incorporated fishery data and fishery-independent survey data through 2018, including revised recreational data provided by MRIP for 1989-2018 (NEFSC 2019b).

The 2019 operational assessment has a regional structure. The stock was modeled as two separate sub-units (north and south) divided approximately at Hudson Canyon. Each sub-unit was modeled separately and the average  $F$ , combined biomass, and SSB across sub-units were used to develop stock-wide reference points. As with the 2016 benchmark assessment, the peer reviewers of the 2019 operational assessment concluded that “although the two-area model had a more severe retrospective pattern in opposite directions in each area sub-unit than when a single unit was assumed, it provides reasonable model estimates after the retrospective corrections and combining the two spatial units. Thus, even though reference points are generated and stock status determinations are conducted for each subunit, the combined projections should be used” (NEFSC 2019b).

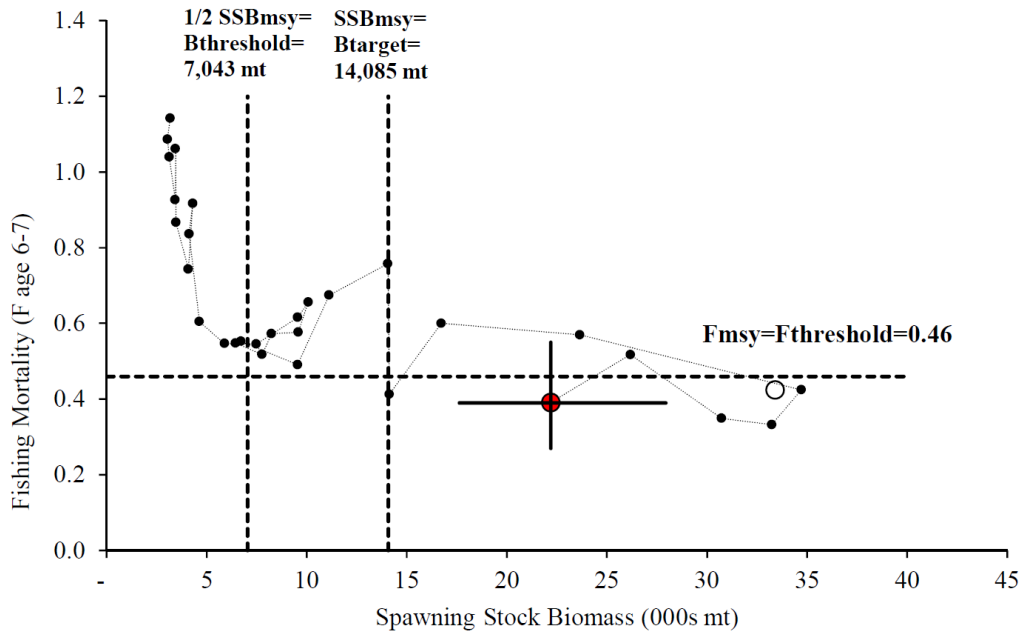
Due to the lack of a stock/recruit relationship, a direct calculation of MSY and associated reference points ( $F$  and SSB) was not feasible and proxy reference points were used. SSB calculations and SSB reference points account for mature males and females. Due to the addition of a second selectivity time block for the non-trawl fleet in the 2019 operational assessment (1989-2008 and 2009-2018, compared to 1989-2015 in the 2016 benchmark assessment), the age at full selection changed from 4-7 in the 2016 benchmark assessment to 6-7 in the 2019 operational assessment (NEFSC 2019b).

A comparison of the 2018 SSB and  $F$  estimates to the reference points suggests that the black sea bass stock north of Cape Hatteras, North Carolina was not overfished and overfishing was not occurring in 2018. SSB in 2018 was estimated at 73.65 million pounds (33,407 mt, adjusted for retrospective bias), 2.4 times the updated biomass reference point (i.e.,  $SSB_{MSY\ proxy} = SSB_{40\%} = 31.07$  million pounds/14,092 mt). The average fishing mortality rate on fully selected ages 6-7 fish in 2018 was 0.42 (adjusted for retrospective bias), 91% of the updated fishing



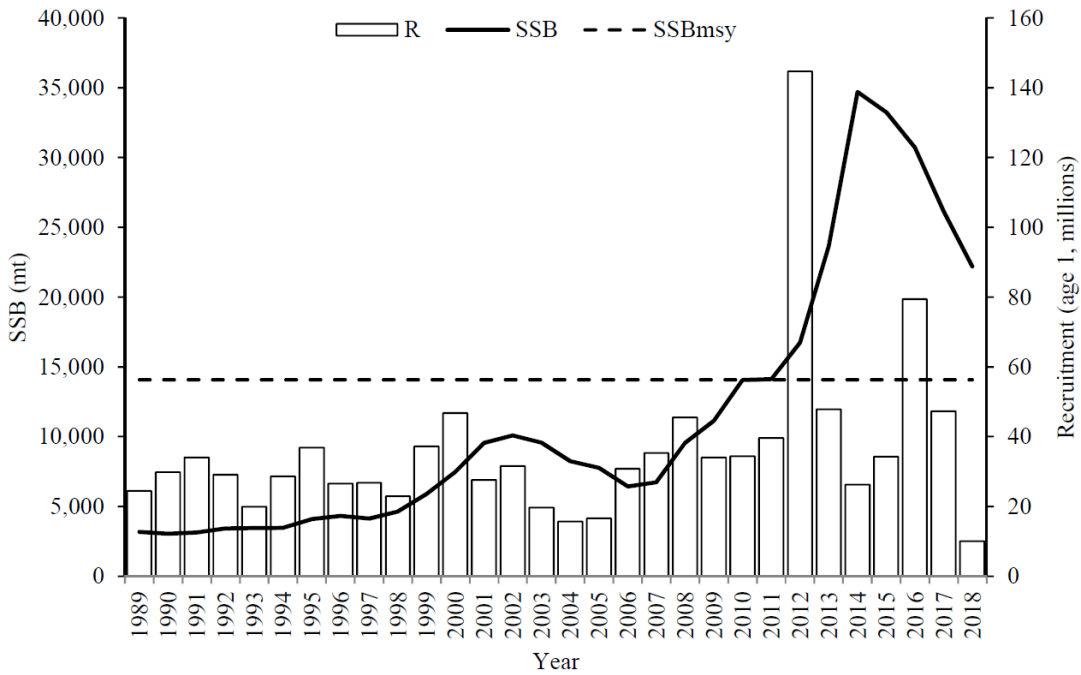
mortality threshold reference point (i.e.,  $F_{MSY\ proxy} = F_{40\%} = 0.46$ ). The 2018 estimates of  $F$  and  $SSB$  were adjusted for internal model retrospective error (Figure 5). Figure 6 and Figure 7 show the time series of estimated  $SSB$ , recruitment, fishing mortality, and catch without retrospective adjustments (NEFSC 2019b).

The 2011 year class was estimated to be the largest in the time series at 144.7 million fish. The 2015 year class was the second largest at 79.4 million fish. Recruitment of the 2017 year class as age 1 in 2018 was estimated at 16.0 million, well below the 1989-2018 average of 36 million fish (Figure 6, NEFSC 2019b).

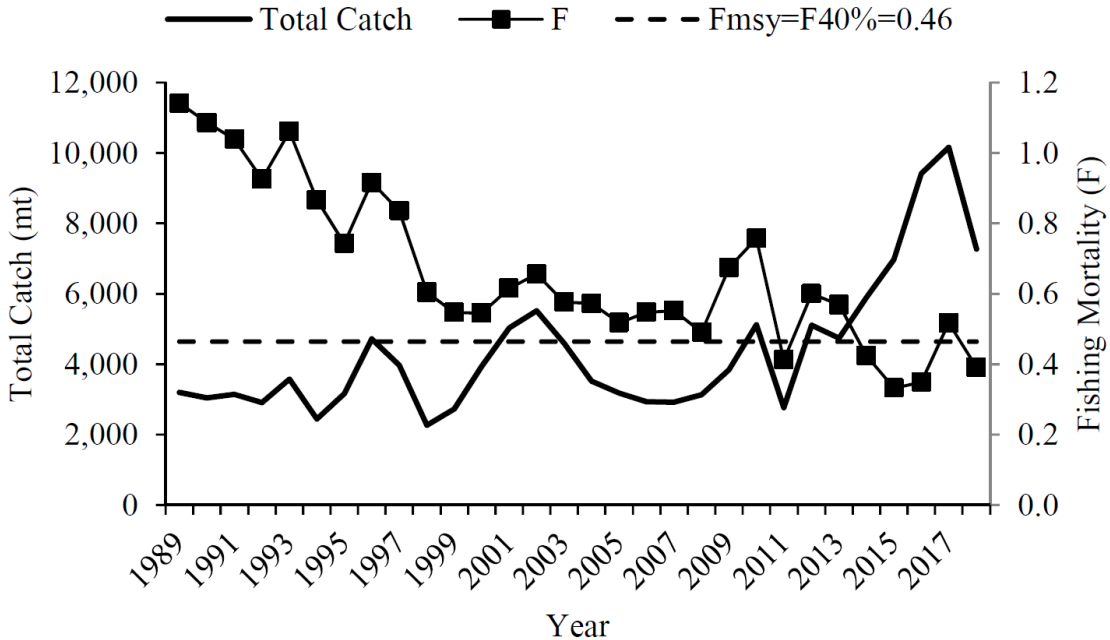


**Figure 5. Estimates of black sea bass spawning stock biomass and fully-recruited fishing mortality relative to the updated biological reference points from the 2019 operational stock assessment. The red filled circle with 90% confidence intervals shows the un-adjusted 2018 estimates. The open circle shows the retrospectively adjusted estimates for 2018. (Source: NEFSC 2019b).**

DRAFT AMENDMENT FOR PUBLIC COMMENT



**Figure 6. Black sea bass SSB and recruitment, 1989-2018 from the 2019 operational stock assessment. The horizontal dashed line is the updated biomass reference point. (Source: NEFSC 2019b).**



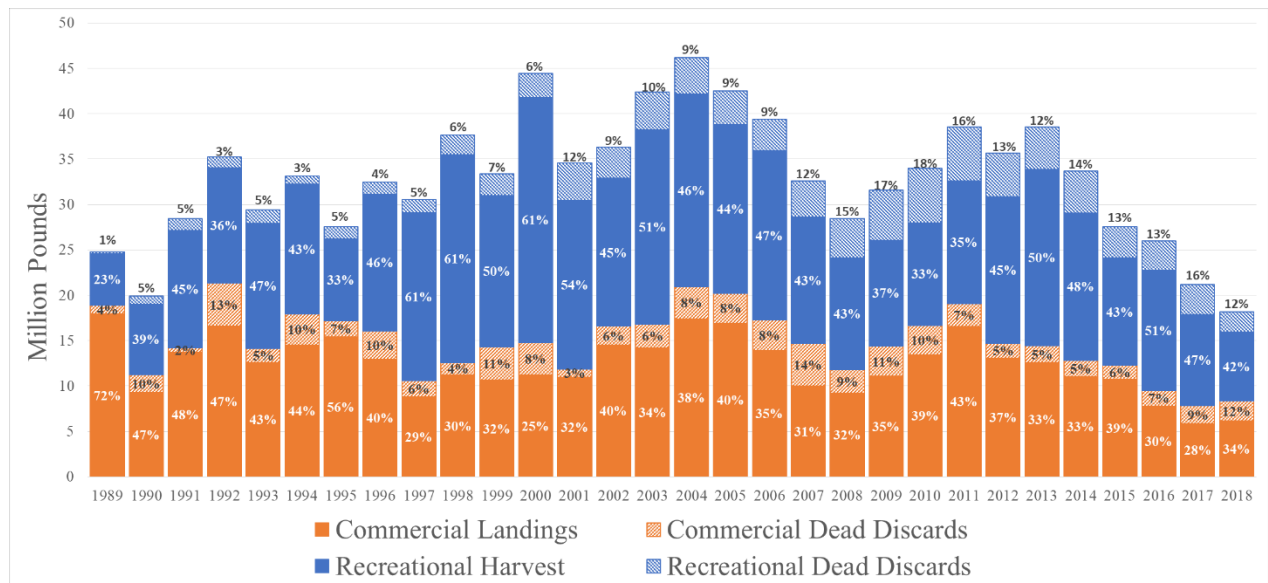
**Figure 7. Total black sea bass catch and fishing mortality, 1989-2018, from the 2019 operational stock assessment. (Source: NEFSC 2019b).**

### 1.3 DESCRIPTION OF THE FISHERIES

#### 1.3.1 Summer Flounder

Summer flounder support important commercial and recreational fisheries along the US Atlantic coast. Data for all fisheries dead catch components (commercial landings, commercial dead discards, recreational landings, and recreational dead discards) are available dating back to 1989. Commercial landings have accounted for 38% of the total catch since 1989, with recreational landings accounting for 45%, commercial dead discards about 8%, and recreational dead discards about 9%. Over the more recent time period of 2014-2018, the comparable percentages are 33% commercial landings, 46% recreational landings, 8% commercial dead discards, and 13% recreational dead discards (Figure 8).

Commercial dead discards have accounted for about 19% of the total commercial catch 2014-2018, assuming a discard mortality rate of 80%. Recreational dead discards have accounted for 22% of the total recreational catch over 2014-2018, assuming a discard mortality rate of 10%.



**Figure 8. Commercial and recreational summer flounder landings and dead discards, 1982-2018. Data retrieved from the Northeast Fisheries Science Center 2019 data update. Commercial discard estimates prior to 1989 are not available.**

#### Summer Flounder Commercial Fishery

The commercial quota is divided among the states based on the allocation percentages outlined in the FMP. In March 2019, the Council and Board approved Amendment 21 to the Summer Flounder, Scup, and Black Sea Bass FMP which modified the commercial state allocation system for summer flounder. The revised allocation system, effective January 1, 2021, modifies the state-specific allocations of the commercial quota in years when the annual coastwide commercial quota exceeds the specified trigger of 9.55 million pounds. Up to 9.55 million pounds of annual coastwide commercial quota is distributed according to the previous state

DRAFT AMENDMENT FOR PUBLIC COMMENT

allocations (column A in Table 1 ), and, in years when the coastwide quota exceeds 9.55 million pounds, the surplus quota will be distributed in equal shares to all states except Maine, Delaware, and New Hampshire, which will split 1% of the surplus quota (column B in Table 1). The total percentage allocated annually to each state is dependent on how much additional quota is available beyond 9.55 million pounds, if any, to be distribute in any given year. This allocation system is designed to provide for more equitable distribution of quota when stock biomass is higher while also considering the historic importance of the fishery to each state.

**Table 1. Revised summer flounder commercial allocation system adopted by the Council and Board in March 2019 and implemented via Amendment 21 to the FMP, effective January 1, 2021.**

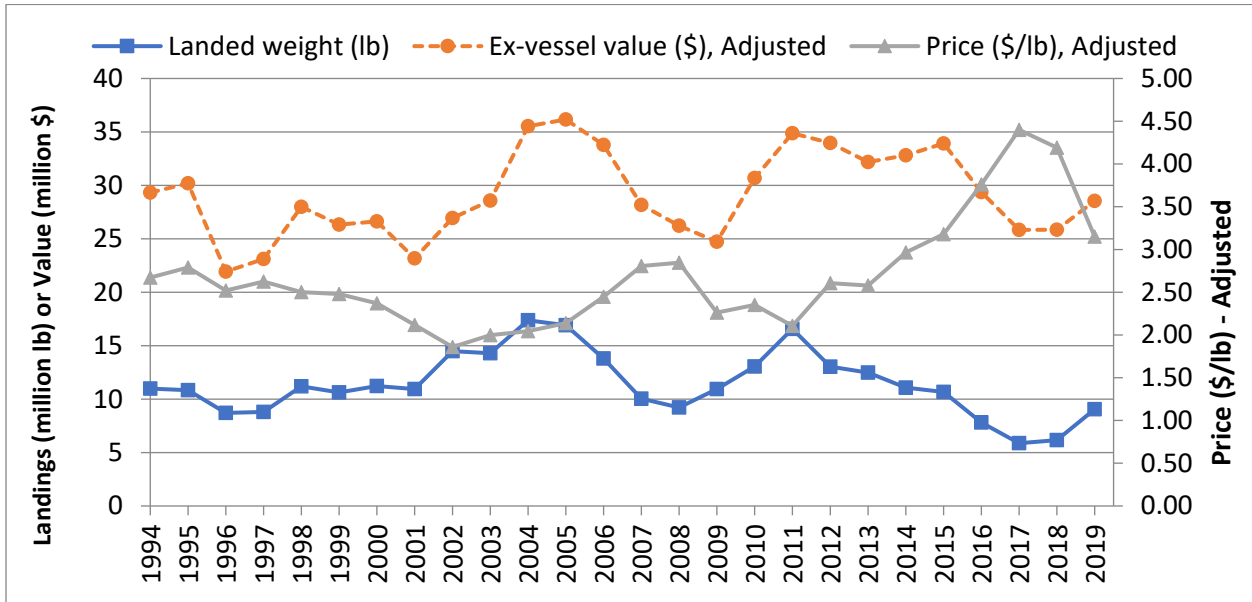
State	A) Allocation of baseline quota ≤9.55 mil lb	B) Allocation of <u>additional</u> quota <u>beyond</u> 9.55 mil lb
ME	0.04756%	0.333%
NH	0.00046%	0.333%
MA	6.82046%	12.375%
RI	15.68298%	12.375%
CT	2.25708%	12.375%
NY	7.64699%	12.375%
NJ	16.72499%	12.375%
DE	0.01779%	0.333%
MD	2.03910%	12.375%
VA	21.31676%	12.375%
NC	27.44584%	12.375%
<b>Total</b>	100%	100%

A moratorium permit is required to sell summer flounder caught in federal waters. In 2019, 738 vessels held such permits. Typically, between 90% and 98% of the summer flounder landings are taken by bottom otter trawl gear, depending on the dataset. All other gear types each accounted for less than 1 percent of landings. Current regulations require a 14-inch total length minimum fish size in the commercial fishery. Trawl nets are required to have 5.5-inch diamond or 6-inch square minimum mesh in the entire net for vessels possessing more than the threshold amount of summer flounder (i.e., 200 lb from November 1-April 30 and 100 lb from May 1-October 31).

Commercial landings of summer flounder peaked in 1984 at 37.77 million pounds and reached a low of 5.83 million pounds in 2017. In 2019, commercial fishermen from Maine through North Carolina landed 9.06 million pounds of summer flounder, about 83% of the 10.98 million pound commercial quota (after deductions for prior year landings and discard overages). Total ex-vessel value in 2019 was \$28.54 million, resulting in an average price per pound of \$3.15 (Figure 9).

DRAFT AMENDMENT FOR PUBLIC COMMENT

For 1994 through 2019, NOAA Fisheries dealer data indicate that summer flounder total ex-vessel revenue from Maine to North Carolina ranged from a low of \$21.93 million in 1996 to a high of \$36.16 million in 2005 (values adjusted to 2019 dollars to account for inflation). The mean price per pound ranged from a low of \$1.86 in 2002 to a high of \$4.40 in 2017 (both values in 2019 dollars). In 2019, 9.06 million pounds of summer flounder were landed generating \$28.54 million in total ex-vessel revenue (an average of \$3.15 per pound; Figure 9).



**Figure 9. Landings, ex-vessel value, and price per pound for summer flounder, Maine through North Carolina, 1994-2019. Ex-vessel value and price are adjusted to real 2019 dollars using the Gross Domestic Product Price Deflator (GDPDEF).**

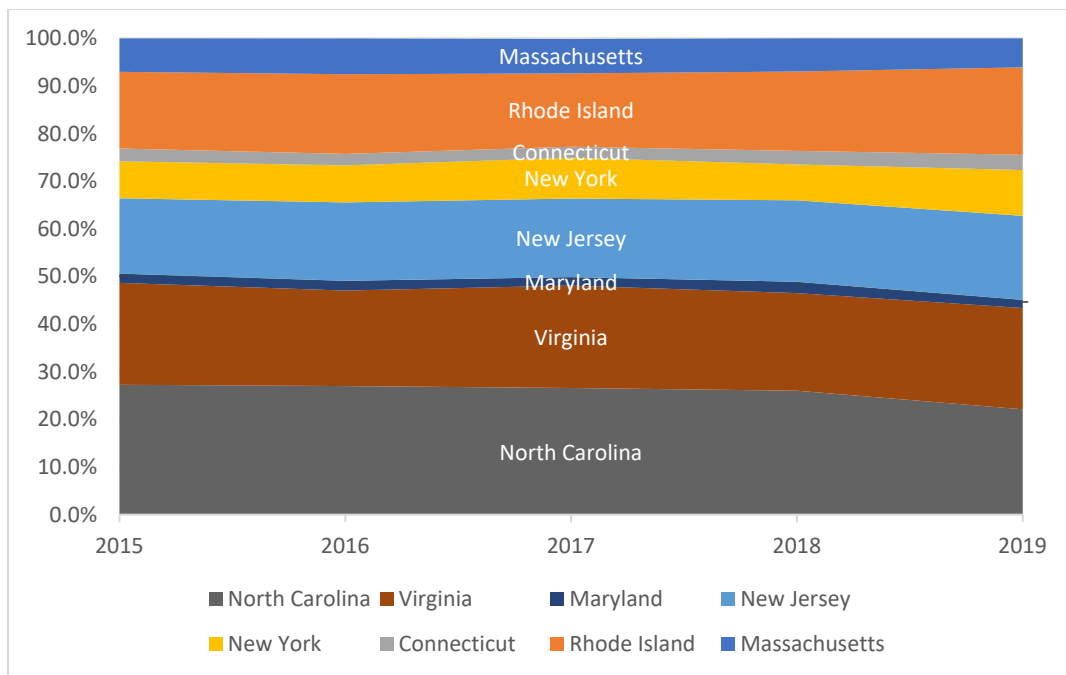
Table 2 shows commercial landings of summer flounder by state in 2015-2019. As a percentage of coastwide landings, landings by state have generally been stable in recent years (Figure 10). From 1993 to 2020, state-level allocations have remained constant, and utilization rates have generally been high among all states involved in the summer flounder fishery.

Commercial summer flounder landings from Maine, New Hampshire, and Delaware are not shown in Figure 10 since landings are minimal, if they occur at all. Delaware landings have consistently been 0.1% or less of coastwide landings each year since 1993 and have averaged less than 0.01% in recent years.

DRAFT AMENDMENT FOR PUBLIC COMMENT

**Table 2. State Commercial Summer Flounder Landings in lbs (2015-2019).** C = confidential data  
 Source: Unpublished NOAA Fisheries commercial fish dealer data (i.e., “DERS”), which include both state and federal dealer data).

State	2015	2016	2017	2018	2019
Massachusetts	748,744	585,647	420,733	427,179	551,399
Rhode Island	1,716,507	1,305,216	897,434	1,022,716	1,662,585
Connecticut	286,770	190,793	134,106	176,587	290,483
New York	830,829	604,079	500,461	461,615	870,363
New Jersey	1,687,866	1,286,136	961,866	1,049,625	1,598,299
Delaware	C	C	C	C	C
Maryland	208,379	158,971	103,285	146,466	155,916
Virginia	2,282,508	1,567,404	1,252,662	1,259,983	1,926,512
North Carolina	2,912,158	2,107,147	1,550,328	1,598,332	2,003,468
Total	10,675,110	7,807,630	5,828,709	6,143,187	9,059,025



**Figure 10. Percentage of coastwide summer flounder commercial landings by state 2015-2019, Massachusetts through North Carolina (excluding Delaware).** Delaware accounts for less than 0.1% of landings each year. Source: Unpublished NOAA Fisheries commercial fish dealer data (i.e., “DERS”), which include both state and federal dealer data).

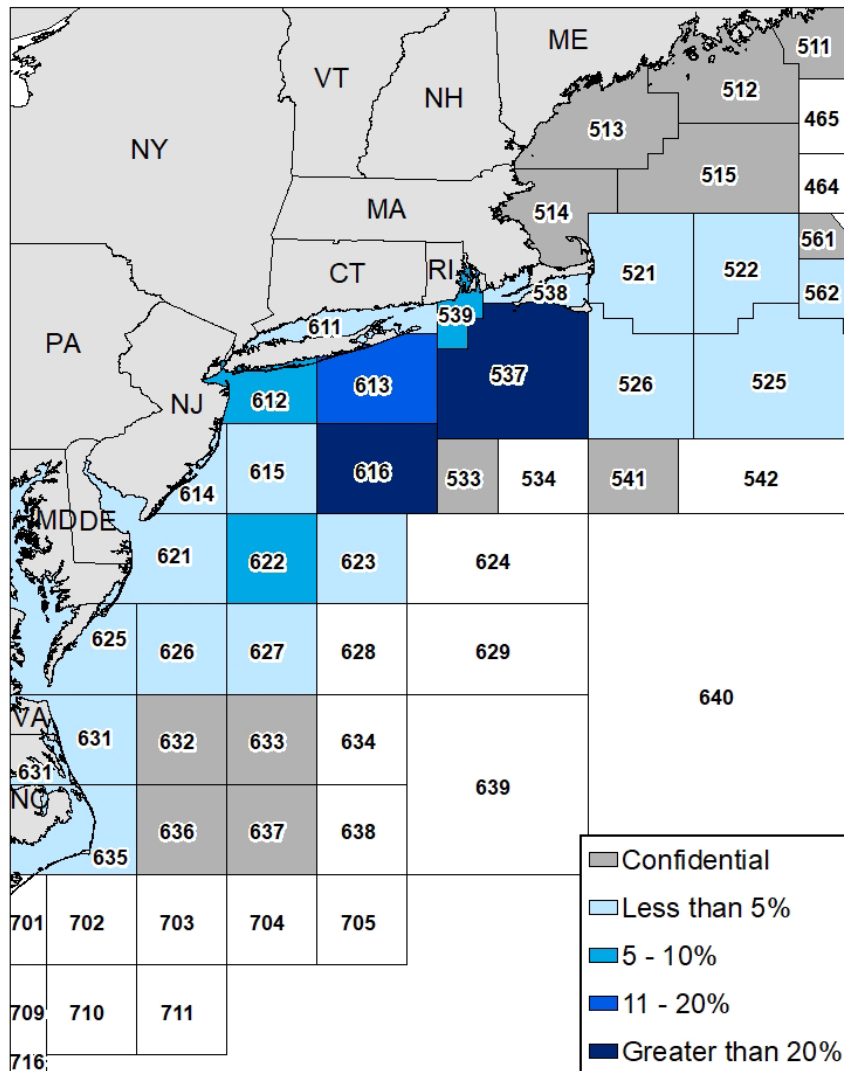
DRAFT AMENDMENT FOR PUBLIC COMMENT

According to federal vessel trip report (VTR) data, statistical areas 616 and 537 were responsible for the highest percentage of commercial summer flounder catch (27% and 23% respectively; Table 3). While statistical area 539 accounted for only 6% of 2019 summer flounder catch, this area had the highest number of trips that caught summer flounder (2,510 trips). Note that all information on VTRs is self-reported by captains (Table 3; Figure 11).

**Table 3. Statistical areas that accounted for at least 5 percent of the total summer flounder catch in 2019, with associated number of trips.**

<b>Statistical Area</b>	<b>Percent of 2019 Commercial Summer Flounder Catch</b>	<b>Number of Trips</b>
616	27%	1,052
537	23%	1,469
613	13%	1,455
622	8%	272
612	7%	1,076
539	6%	2,510

At least 100,000 pounds of summer flounder were landed by commercial fishermen in 17 ports in 8 states in 2019. These ports accounted for 87% of all 2019 commercial summer flounder landings. Point Judith, RI and Beaufort, NC were the leading ports in 2019 in pounds of summer flounder landed, while Point Judith, RI was the leading port in number of vessels landing summer flounder (Table 4).



**Figure 11. Proportion of summer flounder catch by NOAA Fisheries statistical area in 2019 based on federal VTR data. Statistical areas marked “confidential” are associated with fewer than three vessels and/or dealers. Statistical areas with confidential data collectively accounted for less than 1% of commercial catch reported on VTRs in 2019. The amount of catch (landings and discards) that was not reported on federal VTRs (e.g., catch from vessels permitted to fish only in state waters) is unknown. Northeast Fisheries Science Center Data (“AA tables”) suggest that 8% of total commercial landings (state and federal) in 2019 were not associated with a statistical area reported in federal VTRs.**



**Table 4. Ports reporting at least 100,000 pounds of commercial summer flounder landings in 2019, based on dealer data.**

Port	Commercial summer flounder landings (lb)	% of total 2019 commercial summer flounder landings	Number of vessels landing summer flounder
POINT JUDITH, RI	1,446,867	16%	120
BEAUFORT, NC	1,220,608	13%	61
HAMPTON, VA	975,621	11%	58
PT. PLEASANT, NJ	936,899	10%	48
NEWPORT NEWS, VA	713,569	8%	49
MONTAUK, NY	494,045	5%	68
WANCHESE, NC	244,898	3%	14
BELFORD, NJ	235,410	3%	16
CAPE MAY, NJ	226,271	2%	44
ENGELHARD, NC	221,177	2%	10
NEW BEDFORD, MA	214,518	2%	53
CHINCOTEAGUE, VA	212,628	2%	23
HAMPTON BAYS, NY	186,292	2%	31
ORIENTAL, NC	158,368	2%	8

*Summer Flounder Recreational Fishery*

There is a significant recreational fishery for summer flounder, primarily in state waters when the fish migrate inshore during the warm summer months. Summer flounder have historically been highly sought by sport fishermen, especially in New York and New Jersey waters. Characteristics of the recreational fishery are summarized in the sections below.

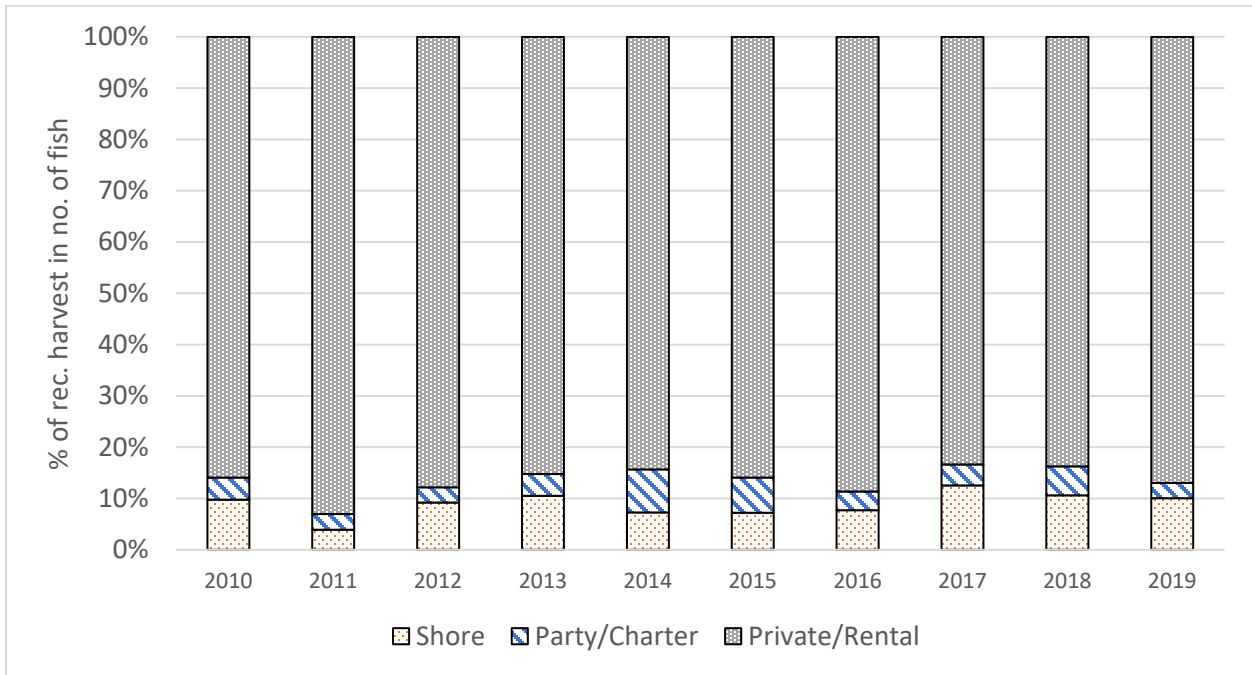
NOAA Fisheries has conducted recreational fishing surveys since 1979 to obtain estimates of participation, effort, and catch by recreational anglers in marine waters. Recreational data for 2004 and later are available from the MRIP. Prior to 2004, recreational data were generated by the Marine Recreational Fishery Statistics Survey (MRFSS). Note that MRIP has recently undergone major changes in its collection of effort data,<sup>2</sup> as well as changes to its angler intercept methods for private boat and shore anglers.<sup>3</sup> As such, major changes to the time series of recreational catch and landings were released in July 2018. A more detailed description of the revisions to the MRIP sampling methodology may be found in Section 1.1.1.1. The revised MRIP data are used in the summary of the recreational fishery below.

Recreational harvest for summer flounder peaked in 1983 at an estimated 36.74 million pounds landed. Recreational harvest dropped in the 1980s to a low of 5.66 million pounds in 1989,

<sup>2</sup> See <https://www.fisheries.noaa.gov/recreational-fishing-data/effort-survey-improvements>

<sup>3</sup> See <https://www.fisheries.noaa.gov/event/access-point-angler-intercept-survey-calibration-workshop>

corresponding with a decline in overall stock biomass over the same time frame. Starting in 1993, coastwide RHLs were implemented for the recreational fishery. Recreational harvest generally increased throughout the 1990s, and then began to decline after about 2000, in part due to decreases in the RHL. In 2019, recreational anglers harvested 7.80 million pounds of summer flounder. From 2010-2019, an average of 86.5% of the harvest (in pounds) originated from private/rental boats, while party/charter boats and shore-based anglers accounted for an average of 4.6% and 8.9% of the harvest, respectively (Figure 12). Recreational dead discard estimates ranged from a low of 0.19 million pounds in 1989 to a high of 5.98 million pounds in 2011. Recreational dead discards averaged 14% of total catch from 2009 to 2018 (Table 5).



**Figure 12. The percent of summer flounder harvested by recreational fishing mode in numbers of fish, Maine through North Carolina, 2010-2019. Source: Personal Communication with the National Marine Fisheries Service, Fisheries Statistics Division, November 18, 2020**

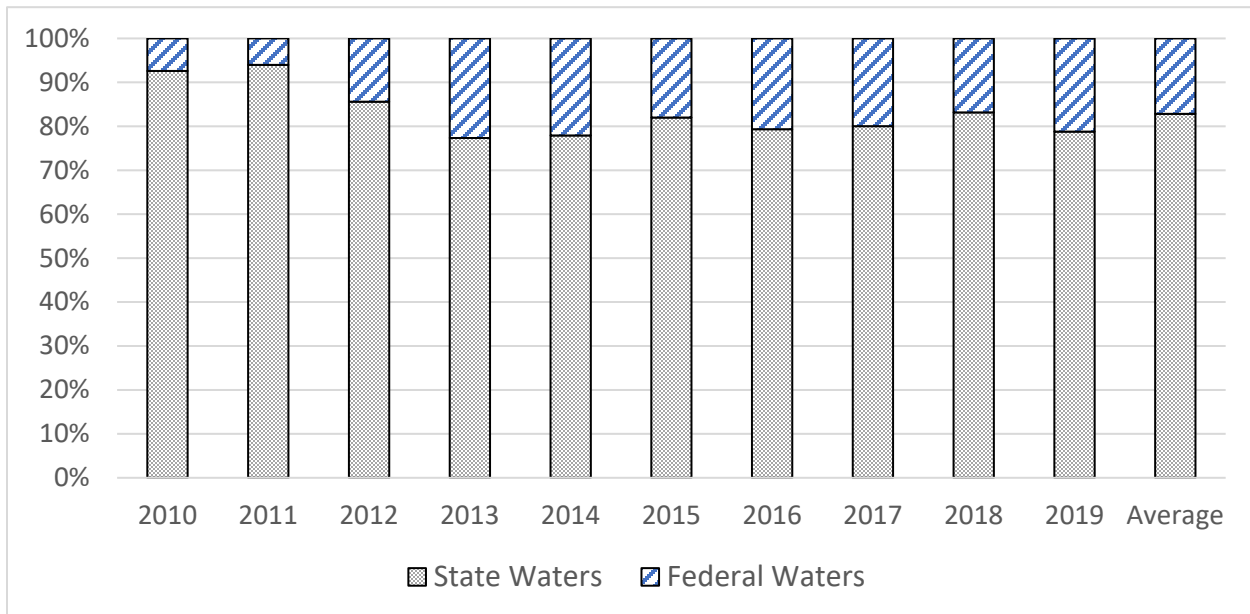
DRAFT AMENDMENT FOR PUBLIC COMMENT

**Table 5. Recreational summer flounder landings, catch, and mean weight of landed fish, Maine through North Carolina, 1981-2019. Source: MRIP**

Year	Catch (number of fish)	Landings (number of fish)	Landings (lbs)	Mean weight of landed fish (lb)
1981	22,764,996	17,017,575	15,854,414	0.93
1982	26,068,143	19,294,418	23,717,755	1.23
1983	36,351,038	25,780,410	36,740,016	1.43
1984	39,817,437	23,448,651	28,225,588	1.20
1985	26,281,245	21,388,987	25,142,403	1.18
1986	32,517,894	16,383,583	26,465,976	1.62
1987	29,936,826	11,926,130	23,453,212	1.97
1988	25,452,018	14,821,583	20,786,915	1.40
1989	5,064,611	3,103,367	5,657,136	1.82
1990	15,473,585	6,074,360	7,753,758	1.28
1991	24,831,911	9,833,938	12,905,506	1.31
1992	21,110,940	8,786,840	12,668,638	1.44
1993	36,182,494	9,800,527	13,729,937	1.40
1994	26,107,588	9,823,384	14,287,672	1.45
1995	27,836,448	5,473,382	9,017,103	1.65
1996	29,744,785	10,184,119	15,020,721	1.47
1997	31,866,871	11,036,807	18,524,759	1.68
1998	39,085,859	12,371,010	22,857,800	1.85
1999	42,878,662	8,096,243	16,696,341	2.06
2000	43,257,486	13,045,422	27,025,386	2.07
2001	43,677,692	8,029,216	18,556,023	2.31
2002	34,480,722	6,505,337	16,286,552	2.50
2003	36,211,634	8,208,884	21,486,707	2.62
2004	37,945,213	8,157,992	21,199,825	2.60
2005	45,979,974	7,044,371	18,545,254	2.63
2006	37,903,008	6,946,548	18,632,354	2.68
2007	35,264,760	4,849,806	13,888,850	2.86
2008	39,482,693	3,781,123	12,339,583	3.26
2009	50,622,466	3,645,119	11,656,844	3.20
2010	58,890,946	3,511,546	11,335,965	3.23
2011	56,043,009	4,326,867	13,483,852	3.12
2012	44,704,755	5,737,284	16,133,620	2.81
2013	44,962,178	6,600,546	19,414,043	2.94
2014	44,577,814	5,364,891	16,234,585	3.03
2015	34,140,115	4,034,036	11,829,854	2.93
2016	31,238,651	4,301,669	13,238,819	3.08
2017	28,075,235	3,174,950	10,088,244	3.18
2018	23,545,865	2,412,514	7,599,646	3.15
2019	30,743,494	2,383,228	7,798,280	3.27

DRAFT AMENDMENT FOR PUBLIC COMMENT

On average, an estimated 83 percent of the landings (in numbers of fish) occurred in state waters over the past ten years (Figure 13). By state, the majority of summer flounder are typically landed in New York and New Jersey (Table 6).



**Figure 13. Estimated percentage of summer flounder recreational landings (numbers of fish) in state vs. federal waters, Maine through North Carolina, 2010-2019. Source: Personal Communication with the National Marine Fisheries Service, Fisheries Statistics Division, November 19, 2020**

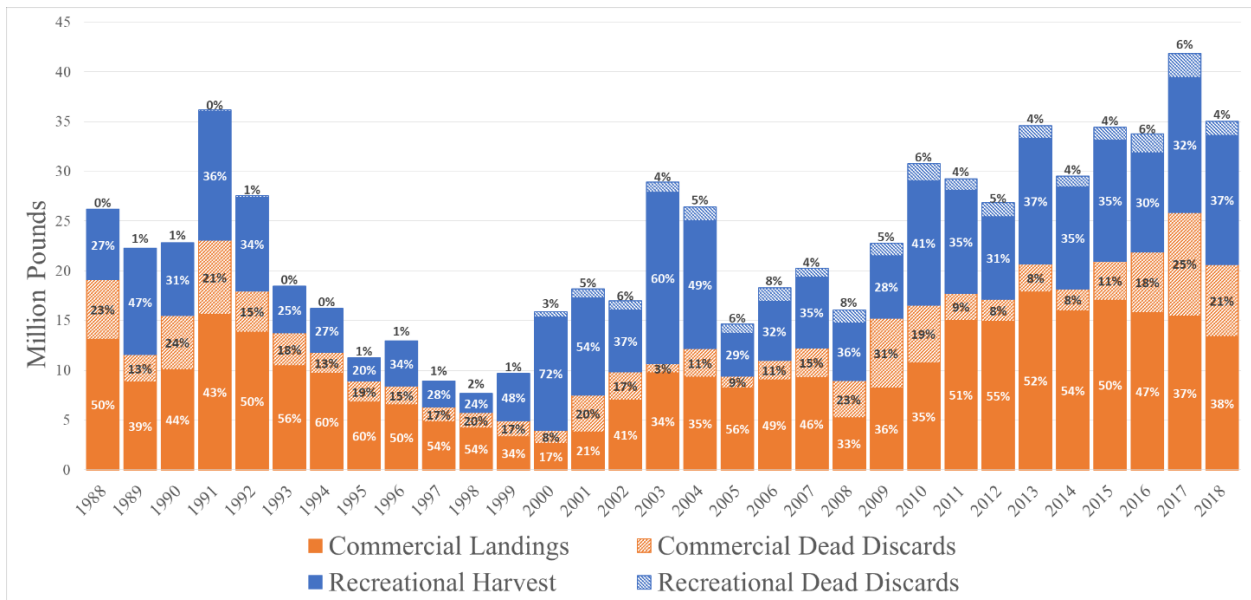
**Table 6. State contribution (as a percentage) to total recreational landings of summer flounder (in numbers of fish), from Maine through North Carolina, 2017-2019. Source: Personal Communication with the National Marine Fisheries Service, Fisheries Statistics Division, November 19, 2020**

State	2017	2018	2019	Avg 2017-2019
Maine	0.0%	0.0%	0.0%	0.0%
New Hampshire	0.0%	0.0%	0.0%	0.0%
Massachusetts	2.1%	2.8%	2.3%	2.4%
Rhode Island	4.9%	7.0%	9.0%	6.8%
Connecticut	3.8%	6.3%	3.8%	4.6%
New York	37.4%	26.6%	23.5%	30.0%
New Jersey	38.1%	43.3%	46.5%	42.2%
Delaware	3.1%	3.5%	3.8%	3.4%
Maryland	1.8%	2.0%	3.3%	2.3%
Virginia	5.9%	6.0%	6.3%	6.1%
North Carolina	2.9%	2.4%	1.5%	2.3%
Total	100.0%	100.0%	100.0%	100.0%

**1.3.2 Scup**

Scup are highly sought after by commercial and recreational fishermen throughout Southern New England and the Mid-Atlantic. Data for all fisheries dead catch components (commercial landings, commercial dead discards, recreational landings, and recreational dead discards) are available back to 1988. Commercial landings have accounted for 45% of the total catch since 1988, with recreational landings accounting for 36%, commercial dead discards about 16%, and recreational dead discards about 3%. Over the more recent time period of 2014-2018, the comparable percentages are 45% commercial landings, 33% recreational landings, 17% commercial dead discards, and 5% recreational dead discards (Figure 14).

Commercial dead discards have accounted for about 27% of the total commercial catch during 2014-2018, assuming a discard mortality rate of 100%. Recreational dead discards have accounted for 12% of the total recreational catch over 2014-2018, assuming a discard mortality rate of 15%.



**Figure 14. Commercial and recreational scup landings and dead discards, 1981-2018. Data retrieved from the 2019 Northeast Fisheries Science Center Scup Operational Assessment.**

*Scup Commercial Fishery*

The commercial scup fishery operates year-round, taking place primarily in federal waters during the winter and state waters during the summer. A coast-wide commercial quota is allocated between three quota periods, known as the winter I, summer, and winter II quota periods (Table 7). These seasonal quota periods were established to ensure that both smaller day boats, which typically operate near shore in the summer months, and larger vessels operating offshore in the winter months can land scup before the annual quota is reached. Both winter periods are managed under a coastwide quota while the summer period quota is divided among states according to the allocation percentages outlined in the FMP (Table 8).

DRAFT AMENDMENT FOR PUBLIC COMMENT

Once the quota for a given period is reached, the commercial fishery is closed for the remainder of that period. If the full winter I quota is not harvested, unused quota is added to the winter II period. Any quota overages during the winter I and II periods are subtracted from the quota allocated to those periods in the following year. Quota overages during the summer period are subtracted from the following year’s quota only in the states where the overages occurred.

A possession limit of 50,000 pounds is in effect during the winter I quota period. A possession limit of 12,000 pounds is in effect during the winter II period. If the winter I quota is not reached, the winter II possession limit increases by 1,500 pounds for every 500,000 pounds of quota not caught during winter I. During the summer period, various state-specific possession limits are in effect.

**Table 7. Dates, allocations, and possession limits for the commercial scup quota periods. Winter period possession limits apply in both state and federal waters.**

Quota Period	Dates	% of commercial quota allocated	Possession limit
Winter I	January 1 – April 30	45.11%	50,000 pounds, until 80% of winter I allocation is reached, then reduced to 1,000 pounds.
Summer	May 1 – September 30	38.95%	State-specific
Winter II	October 1 – December 31	15.94%	12,000 pounds. If winter I quota is not reached, the winter II possession limit increases by 1,500 pounds for every 500,000 pounds of scup not landed during winter I.

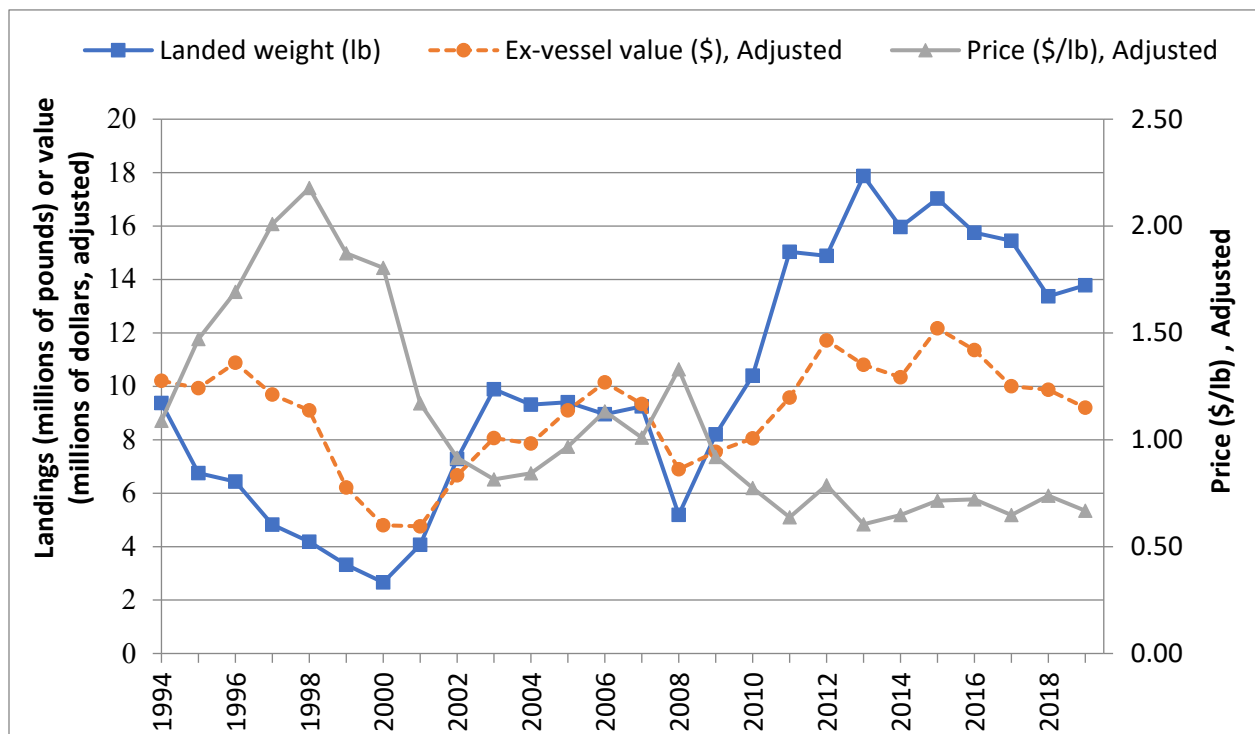
**Table 8. State quota shares for the commercial scup fishery during the summer quota period (May-September).**

State	Share of summer quota
Maine	0.1210%
Massachusetts	21.5853%
Rhode Island	56.1894%
Connecticut	3.1537%
New York	15.8232%
New Jersey	2.9164%
Maryland	0.0119%
Virginia	0.1650%
North Carolina	0.0249%
Total	99.9908%

DRAFT AMENDMENT FOR PUBLIC COMMENT

Trawl vessels may not possess 1,000 pounds or more of scup during October 1 – April 15, 2,000 pounds or more April 15 – June 15, or 200 pounds or more during June 15 – September 30, unless they use a minimum mesh size of 5-inch diamond mesh, applied throughout the codend for at least 75 continuous meshes forward of the terminus of the net. In addition, the roller rig trawl roller diameter may not exceed 18 inches. Pots and traps for scup are required to have degradable hinges and escape vents that are either circular with a 3.1 inch minimum diameter or square with a minimum length of 2.25 inches on the side.

In 2019, commercial fishermen landed 13.78 million pounds of scup, about 57% of the commercial quota. Over the past two decades, total scup ex-vessel revenue ranged from a low of \$4.8 million in 2000 to a high of \$12.2 million in 2015. In 2019, 13.78 million pounds of scup were landed by commercial fishermen from Maine through North Carolina. Total ex-vessel value in 2019 was \$9.20 million, resulting in an average price per pound of \$0.67. All revenue and price values were adjusted to 2019 dollars to account for inflation (Figure 15).



**Figure 15. Landings, ex-vessel value, and price for scup from Maine through North Carolina, 1994-2019. Ex-vessel value and price are inflation-adjusted to 2019 dollars using the Gross Domestic Product Price Deflator. Source: Unpublished NOAA Fisheries commercial fish dealer data (i.e., “DERS”), which include both state and federal dealer data).**

In general, the price of scup tends to be lower when landings are higher, and vice versa. This relationship is not linear and many other factors besides landings also influence price. The highest average price per pound over the past two decades was \$2.18 in 1998, and the lowest average price per pound was \$0.60 in 2013 (Figure 15).

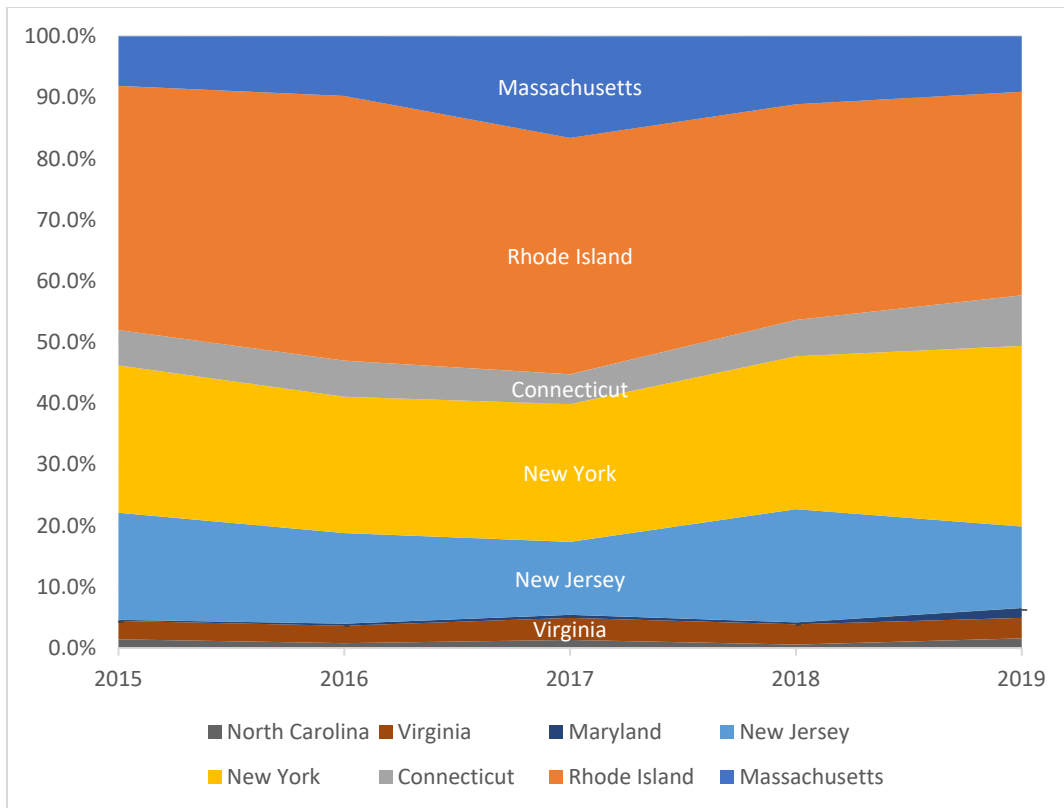
DRAFT AMENDMENT FOR PUBLIC COMMENT

Table 9 shows commercial landings of scup by state in 2015-2019. State landings have fluctuated some in recent years (Figure 16). Most notably, Rhode Island’s contribution to the coastwide total landings has decreased in recent years. Most harvest occurs within Massachusetts, Rhode Island, Connecticut, New York, and New Jersey. Commercial scup landings from Maine, New Hampshire, and Delaware are not shown in Figure 16 since landings are minimal, if they occur at all.

**Table 9. State Commercial Scup Landings in lbs (2015-2019). C = confidential data Source: Unpublished NOAA Fisheries commercial fish dealer data (i.e, “DERS”), which include both state and federal dealer data).**

State	2015	2016	2017	2018	2019
Massachusetts	1,380,256	1,535,953	2,564,229	1,483,151	1,249,085
Rhode Island	6,798,185	6,815,478	5,968,327	4,713,371	4,586,975
Connecticut	981,407	933,140	751,955	793,806	1,140,224
New York	4,102,589	3,509,145	3,478,441	3,342,569	4,069,395
New Jersey	2,981,577	2,333,578	1,844,573	2,474,239	1,835,545
Delaware	C	C	C	C	C
Maryland	29,430	53,535	75,280	42,808	222,251
Virginia	510,930	447,218	557,833	441,544	462,085
North Carolina	245,584	127,656	204,673	76,916	218,113
Total	17,029,966	15,755,755	15,446,089	13,368,410	13,783,703





**Figure 16. Percentage of coastwide scup commercial landings by state 2015-2019, Massachusetts through North Carolina (excluding Delaware). Delaware accounts for less than 0.1% of landings each year. Source: Unpublished NOAA Fisheries commercial fish dealer data (i.e., “DERS”), which include both state and federal dealer data).**

VTR data suggest that NOAA Fisheries statistical areas 537, 613, 616, 539 and 611 were responsible for the largest percentage of commercial scup catch in 2019. Statistical area 539, off Rhode Island, had the highest number of trips which caught scup (Table 10; Figure 17).

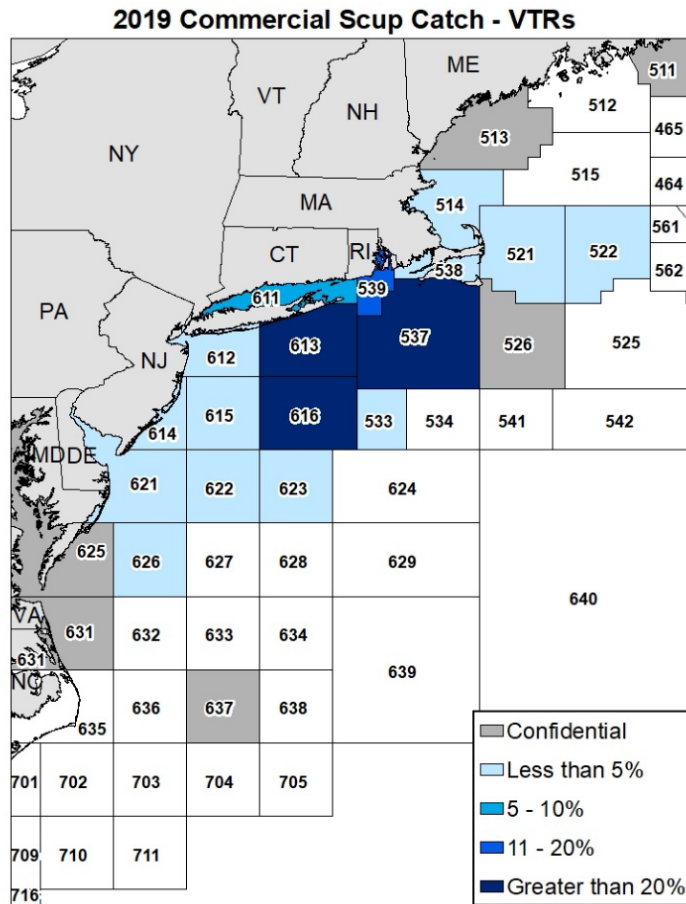
**Table 10. Statistical areas which accounted for at least 5% of the total commercial scup catch (by weight) in 2019, with associated number of trips. Unpublished NOAA Fisheries dealer data (i.e., “AA tables”, which include both state and federal dealer data).**

Statistical area	% of 2019 commercial scup catch	Number of trips
537	22%	1060
613	21%	1141
616	20%	627
539	12%	2268
611	6%	1729

The commercial scup fishery in state and federal waters is predominantly a bottom otter trawl fishery. In 2019, about 81% of the commercial scup landings (by weight) reported by state and

federal dealers were caught with bottom otter trawls. Pots/traps accounted for about 5% of landings, handlines accounted for 2% of landings, while all other gear types each accounted for 1% or less of the 2019 commercial scup landings. Nine percent of landings reported by dealers were of an unknown gear type. This includes landings from vessels that are only permitted to fish in state waters and do not submit federal VTRs, resulting in incomplete information on gear type in the data set.

At least 100,000 pounds of scup were landed by commercial fishermen in 18 ports in 6 states in 2019. These ports accounted for approximately 90% of all 2019 commercial scup landings. Point Judith, Rhode Island was the leading port, both in terms of landings and number of vessels landing scup (Table 11).



**Figure 17. Proportion of scup catch by statistical area in 2019 based on federal VTR data. Statistical areas marked “confidential” are associated with fewer than three vessels and/or dealers. Statistical areas with confidential data collectively accounted for less than 1% of commercial catch reported on VTRs in 2019. Northeast Fisheries Science Center Data (“AA tables”) suggest that 18% of total commercial landings (state and federal) in 2019 were not associated with a statistical area reported in federal VTRs. Source: Unpublished NOAA Fisheries Vessel Trip Report data.**

**Table 11. Ports reporting at least 100,000 pounds of commercial scup landings in 2019, based on dealer data.**

Port	Scup Landings (lb)	% of total commercial scup landings	Number of vessels landing scup
POINT JUDITH, RI	3,831,399	28%	127
MONTAUK, NY	2,939,960	21%	76
PT. PLEASANT, NJ	1,382,156	10%	36
NEW BEDFORD, MA	902,313	7%	52
STONINGTON, CT	539,479	4%	19
MATTITUCK, NY	326,299	2%	7
NEW LONDON, CT	325,359	2%	7
HAMPTON BAYS, NY	315,355	2%	30
CAPE MAY, NJ	304,501	2%	20
HAMPTON, VA	275,071	2%	39
LITTLE COMPTON, RI	236,024	2%	11
OCEAN CITY, MD	222,251	2%	4
EAST HAVEN, CT	196,976	1%	7
WARWICK, RI	164,180	1%	C
AMMAGANSETT, NY	142,573	1%	C
BELFORD, NJ	127,752	1%	15
NEWPORT, RI	121,788	1%	11
CHINCOTEAGUE, VA	109,757	1%	12

### *Scup Recreational Fishery*

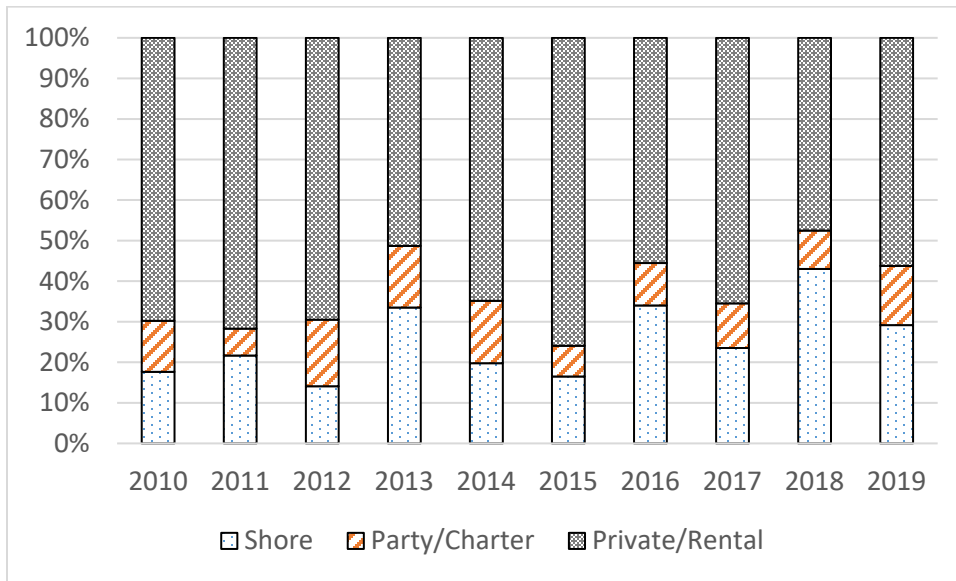
Scup are highly sought after by recreational anglers throughout Southern New England and the Mid-Atlantic with the greatest proportion of catch taken in the states of Massachusetts through New York. Scup are a migratory schooling species and abundance is primarily influenced by water temperature, making them a popular target of anglers during the spring and summer months when they aggregate inshore to spawn. The 2018 MRIP recalibration resulted in higher harvest estimates throughout the time series, with more divergence in recent years. The revised MRIP data is used in describing the characteristics of the scup recreational fishery in the sections below.

The recreational fishery for scup is significant, with recreational anglers accounting for 21 -75% of total dead scup catch from 1988-2018. From 1981-2019, recreational catch of scup peaked in 2017 at 41.20 million scup and landings peaked in 1986 with an estimated 30.43 million scup landed by recreational fishermen from Maine through North Carolina. Recreational catch was lowest in 1997 with an estimated 6.60 million scup were caught and 3.64 million scup were landed. Recreational anglers from Maine through North Carolina caught an estimated 28.67 million scup and landed 14.95 million scup (about 14.12 million pounds) in 2019 (Table 12).

Based on MRIP estimates, about 56% of recreational scup landings (in numbers of fish) in 2019 were from anglers who fished on private or rental boats. About 15% were from anglers fishing on party or charter boats, and about 29% were from anglers fishing from shore (Figure 18).

Most recreational scup harvest occurs in state waters during the warmer months when the fish migrate inshore. Between 2017 and 2019, about 97% of recreational scup landings (in numbers of fish) occurred in state waters and about 3% occurred in federal waters (Figure 19).

Massachusetts, Rhode Island, Connecticut, New York and New Jersey accounted for over 99.9% of recreational scup harvest in 2019 (Table 13).

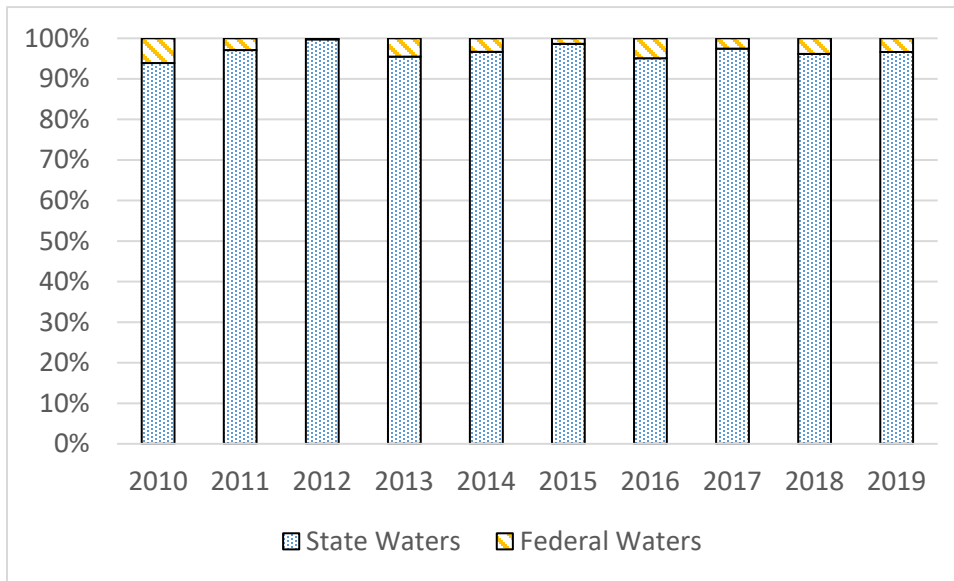


**Figure 18. The percent of scup harvested by recreational fishing mode in numbers of fish, Maine through North Carolina, 2010-2019. Source: Personal Communication with the National Marine Fisheries Service, Fisheries Statistics Division, November 19, 2020**

DRAFT AMENDMENT FOR PUBLIC COMMENT

**Table 12. Recreational scup landings, catch, and mean weight of landed fish, Maine through North Carolina, 1981-2019. Source: MRIP**

Year	Catch (number of fish)	Landings (number of fish)	Landings (lbs)	Mean weight of landed fish (lb)
1981	19,682,427	17,306,715	11,142,808	0.64
1982	13,144,424	10,831,746	8,616,308	0.80
1983	13,781,182	12,189,386	8,621,722	0.71
1984	11,379,028	8,780,947	3,283,595	0.37
1985	24,564,765	18,837,853	11,292,539	0.60
1986	37,311,025	30,428,119	14,175,636	0.47
1987	18,108,256	14,030,569	10,409,377	0.74
1988	12,135,744	9,387,808	7,034,147	0.75
1989	23,728,813	19,323,875	10,540,661	0.55
1990	18,263,733	14,040,609	7,172,993	0.51
1991	27,408,916	21,896,663	12,912,660	0.59
1992	20,961,940	16,495,873	9,454,191	0.57
1993	10,705,511	8,401,830	4,631,187	0.55
1994	8,857,521	6,578,378	4,329,138	0.66
1995	6,783,845	4,063,766	2,270,722	0.56
1996	10,380,915	6,266,686	4,417,936	0.70
1997	6,595,887	3,639,312	2,539,961	0.70
1998	6,855,801	2,738,350	1,816,527	0.66
1999	10,986,627	7,413,089	4,625,639	0.62
2000	22,057,668	14,942,136	11,391,602	0.76
2001	21,933,490	11,132,585	9,774,943	0.88
2002	17,359,007	7,074,231	6,229,973	0.88
2003	28,629,886	17,519,827	17,208,925	0.98
2004	26,791,386	12,943,025	12,827,920	0.99
2005	13,193,600	4,487,025	4,296,294	0.96
2006	20,073,152	5,521,172	5,926,311	1.07
2007	17,804,784	7,457,872	7,099,945	0.95
2008	19,513,012	5,650,032	5,760,290	1.02
2009	20,748,181	6,064,111	6,284,583	1.04
2010	25,134,562	10,598,650	12,477,168	1.18
2011	18,520,338	7,598,242	10,322,642	1.36
2012	21,237,835	7,334,829	8,269,295	1.13
2013	25,878,520	11,547,028	12,635,882	1.09
2014	20,876,838	9,488,944	10,270,446	1.08
2015	25,154,964	11,498,780	12,174,253	1.06
2016	31,493,863	9,143,576	9,999,289	1.09
2017	41,199,436	13,820,613	13,526,579	0.98
2018	30,374,926	14,545,491	12,977,417	0.89
2019	28,666,419	14,954,156	14,116,223	0.94



**Figure 19. Estimated percentage of scup recreational landings (numbers of fish) in state vs. federal waters, Maine through North Carolina, 2010-2019. Source: Personal Communication with the National Marine Fisheries Service, Fisheries Statistics Division, November 19, 2020**

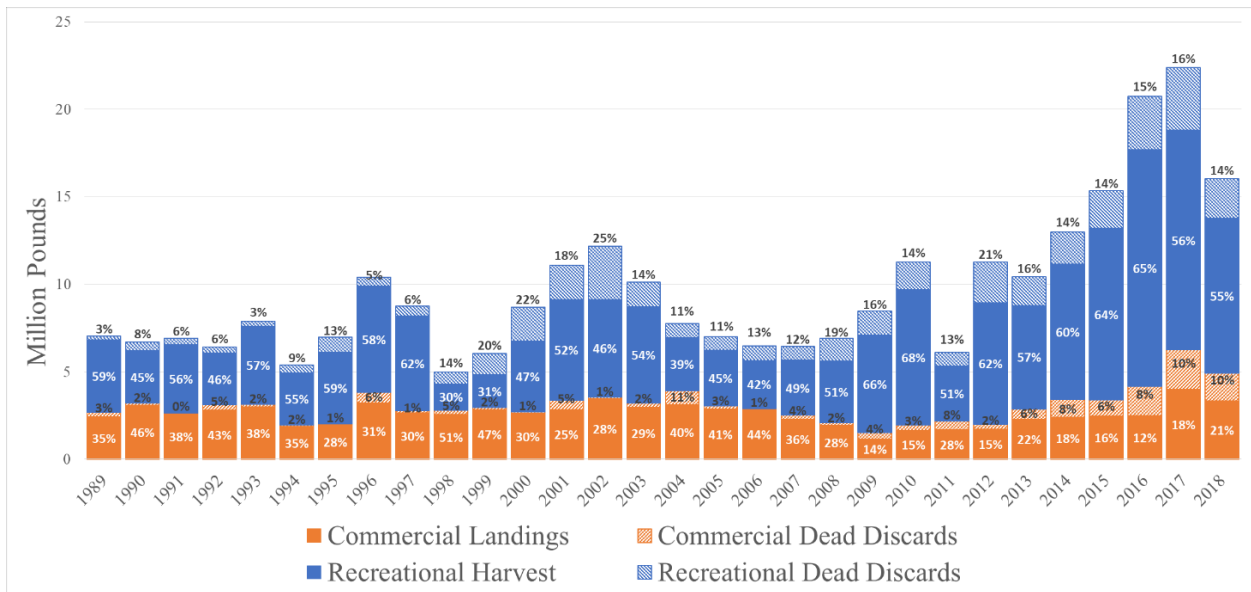
**Table 13. State contribution (as a percentage) to total recreational landings of scup (in numbers of fish), from Maine through North Carolina, 2017-2019. Source: Personal Communication with the National Marine Fisheries Service, Fisheries Statistics Division, November 19, 2020**

State	2017	2018	2019	Avg 2017-2019
Maine	0.0%	0.0%	0.0%	0.0%
New Hampshire	0.0%	0.0%	0.0%	0.0%
Massachusetts	15.1%	22.5%	13.1%	16.9%
Rhode Island	10.0%	16.3%	21.9%	16.1%
Connecticut	12.3%	21.1%	16.7%	16.7%
New York	46.8%	36.9%	47.6%	43.8%
New Jersey	15.8%	3.2%	0.7%	6.5%
Delaware	<0.1%	<0.1%	0.0%	<0.1%
Maryland	<0.1%	<0.1%	<0.1%	<0.1%
Virginia	0.0%	0.0%	<0.1%	<0.1%
North Carolina	<0.1%	<0.1%	<0.1%	<0.1%
Total	100%	100%	100%	100%

**1.3.3 Black Sea Bass**

Black sea bass support important commercial and recreational fisheries along the US Atlantic coast. Data for all dead catch components (commercial landings, commercial dead discards, recreational landings, and recreational dead discards) are available back to 1989. Commercial landings have accounted for 30% of the total dead catch since 1988, with recreational landings accounting for 53%, commercial dead discards about 4%, and recreational dead discards about 13%. Over the more recent time period of 2014-2018, the comparable percentages are 17% commercial landings, 60% recreational landings, 8% commercial dead discards, and 15% recreational dead discards (Figure 20).

Commercial dead discards have accounted for about 33% of the total *commercial* catch 2014-2018, assuming a discard mortality rate of 100% in the commercial trawl fishery and 15% in the commercial non-trawl fishery. Recreational dead discards have accounted for 20% of the total *recreational* catch over 2014-2018, assuming a discard mortality rate of 15%.



**Figure 20. Commercial and recreational black sea bass landings and discards, 1989-2018. Data retrieved from the 2019 Northeast Fisheries Science Center Black Sea Bass Operational Assessment.**

*Black Sea Bass Commercial Fishery*

The commercial quota is divided among the states based on the allocation percentages established in the FMP. States set measures to achieve their state-specific commercial quotas. The Council and Commission are currently developing a management action to consider if these state allocations should be modified.

**Table 14. Black sea bass state by state allocation of annual commercial quota.**

State	Percent Allocation
ME	0.50%
NH	0.50%
MA	13%
RI	11%
CT	1%
NY	7%
NJ	20%
DE	5%
MD	11%
VA	20%
NC	11%
<b>Total</b>	<b>100%</b>

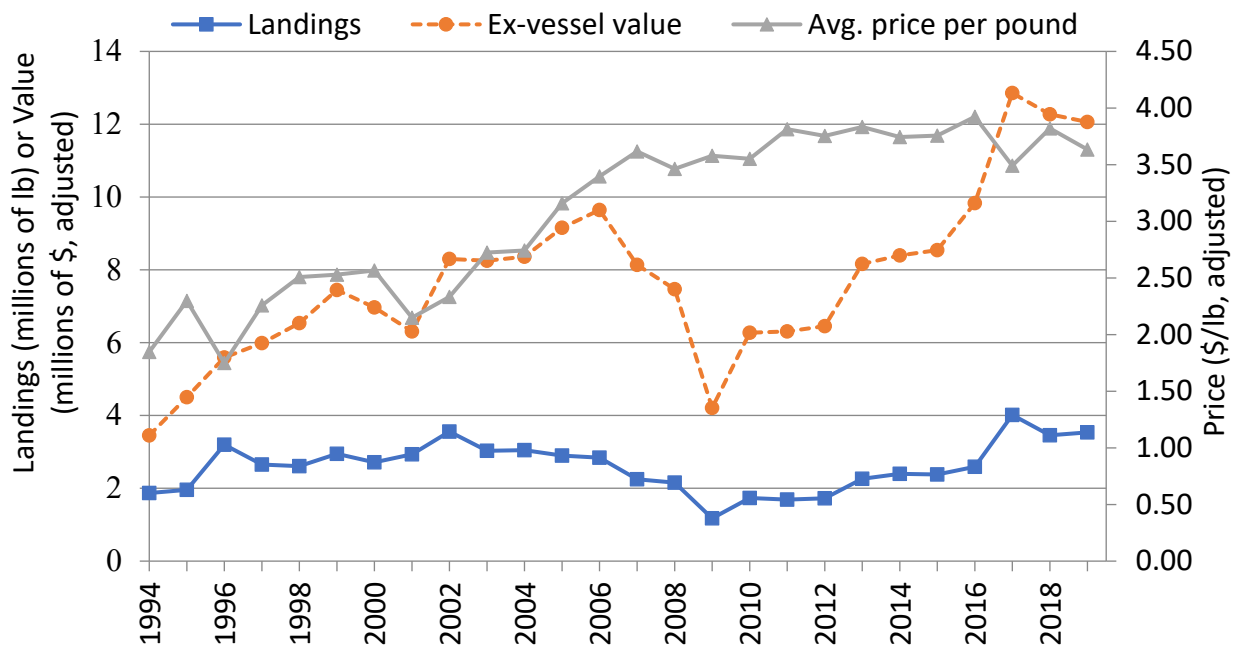
A minimum commercial black sea bass size limit of 11 inches total length has been in place since 2002. There is no commercial possession limit for black sea bass in federal waters; however, states set possession limits for state waters. Any vessel which uses otter trawl gear and catches more than 500 pounds of black sea bass from January through March, or more than 100 pounds from April through December, must use nets with a minimum mesh size of 4.5-inch diamond mesh applied throughout the codend for at least 75 continuous meshes forward of the end of the net. In addition, the roller rig trawl roller diameter may not exceed 18 inches. Pots and traps used to commercially harvest black sea bass must have two escape vents with degradable hinges in the parlor. The escape vents must measure 1.375 inches by 5.75 inches if rectangular, 2 inches by 2 inches if square, or have a diameter of 2.5 inches if circular.

Commercial black sea bass landings peaked in 2017 at 3.99 million pounds, and were at their lowest in 2009, when 1.15 million pounds were landed (Figure 21). About 3.48 million pounds of black sea bass were landed by commercial fishermen in 2019, very close to the commercial quota of 3.52 million pounds.

Black sea bass are a valuable commercial species. Total ex-vessel value averaged \$12.40 million per year during 2017-2019. When considered at the annual, coastwide level, the average ex-vessel price per pound (adjusted to 2019 dollars to account for inflation) during 2005-2019 tended to decline with increases in total landings. However, average ex-vessel price remained above \$3.00 per pound (in 2019 dollars) throughout this time period, making black sea bass one of the more valuable commercial species in this region.

Table 15 shows commercial landings of black sea bass by state for 2015-2019. As a percentage of coastwide landings, landings by state have generally been stable in recent years and closely align with the state allocations (Figure 22). Commercial black sea bass landings from Maine and New Hampshire are not shown since landings are minimal, if they occur at all.

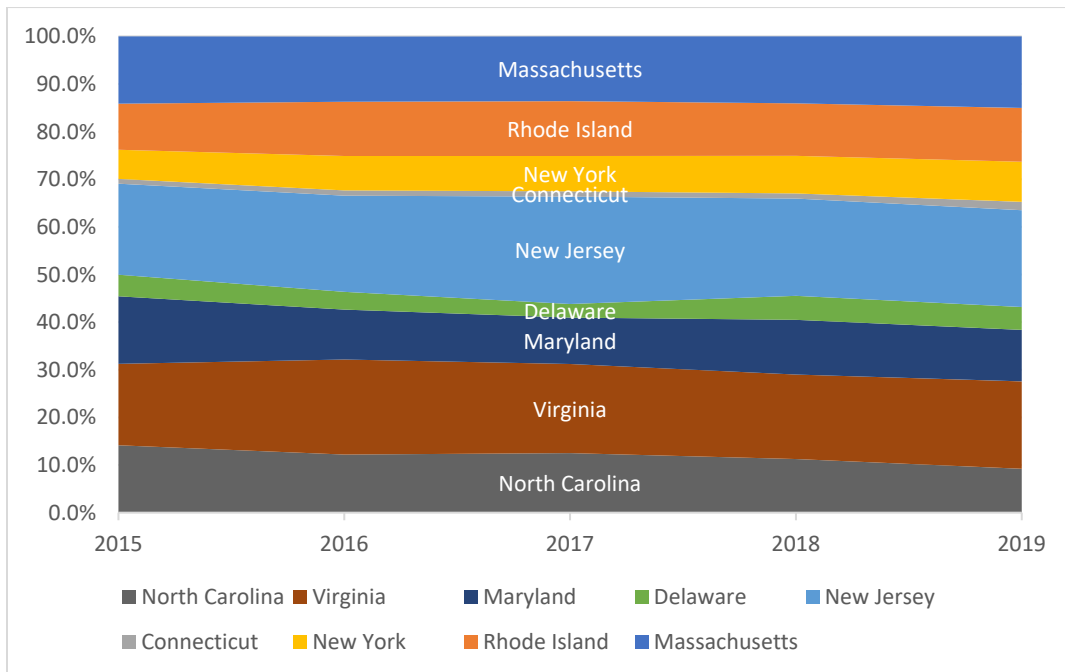




**Figure 21. Landings, ex-vessel value, and average price for black sea bass, ME-NC, 1994-2019. Ex-vessel value and price are inflation-adjusted to 2019 dollars using the Gross Domestic Product Price Deflator. Source: Unpublished NOAA Fisheries commercial fish dealer data (i.e, “DERS”), which include both state and federal dealer data).**

**Table 15. State Commercial Black Sea Bass Landings in lbs (2015-2019). C = confidential data Source: Unpublished NOAA Fisheries commercial fish dealer data (i.e, “DERS”), which include both state and federal dealer data).**

State	2015	2016	2017	2018	2019
Massachusetts	347,980	354,069	542,095	480,810	530,827
Rhode Island	238,635	294,693	458,299	376,062	399,524
Connecticut	24,593	28,859	43,742	37,070	61,965
New York	150,898	187,032	296,269	269,371	297,469
New Jersey	471,009	523,120	898,674	697,571	718,486
Delaware	111,510	C	114,033	172,180	169,748
Maryland	349,273	271,809	389,118	391,998	382,006
Virginia	421,661	516,731	745,446	606,664	648,715
North Carolina	348,592	315,661	498,142	384,500	325,714
Total	2,464,151	2,588,768	3,985,818	3,416,226	3,534,454



**Figure 22. Percentage of coastwide black sea bass commercial landings by state 2015-2019, Massachusetts through North Carolina. Source: Unpublished NOAA Fisheries commercial fish dealer data (i.e., “DERS”), which include both state and federal dealer data).**

According to federal VTR data, statistical area 616, which includes important fishing areas near Hudson Canyon, was responsible for the largest percentage of commercial black sea bass catch (landings and discards) in 2019 (i.e., 39%). Statistical area 621, off southern New Jersey, Delaware, and Maryland accounted for the second highest proportion of catch (9%), followed by statistical area 622 off Delaware (8%), statistical area 615 off New Jersey (7%), and statistical area 537, south of Massachusetts and Rhode Island (5%; Table 16, Figure 23). Statistical area 611, in Long Island Sound, and statistical area 539, off Rhode Island, had the highest number of trips which reported black sea bass catch on federal VTRs in 2019 (over 1,500 trips each); however they each accounted for less than 5% of total black sea bass catch.

**Table 16. Statistical areas that accounted for at least 5% of the total commercial black sea bass catch in 2019 based on federal VTRs, with associated number of trips. Source: Unpublished NOAA Fisheries VTR data**

Statistical Area	Percent of 2019 Commercial Black Sea Bass Catch	Number of Trips
616	39%	761
621	10%	332
622	8%	104
615	7%	175
537	5%	774

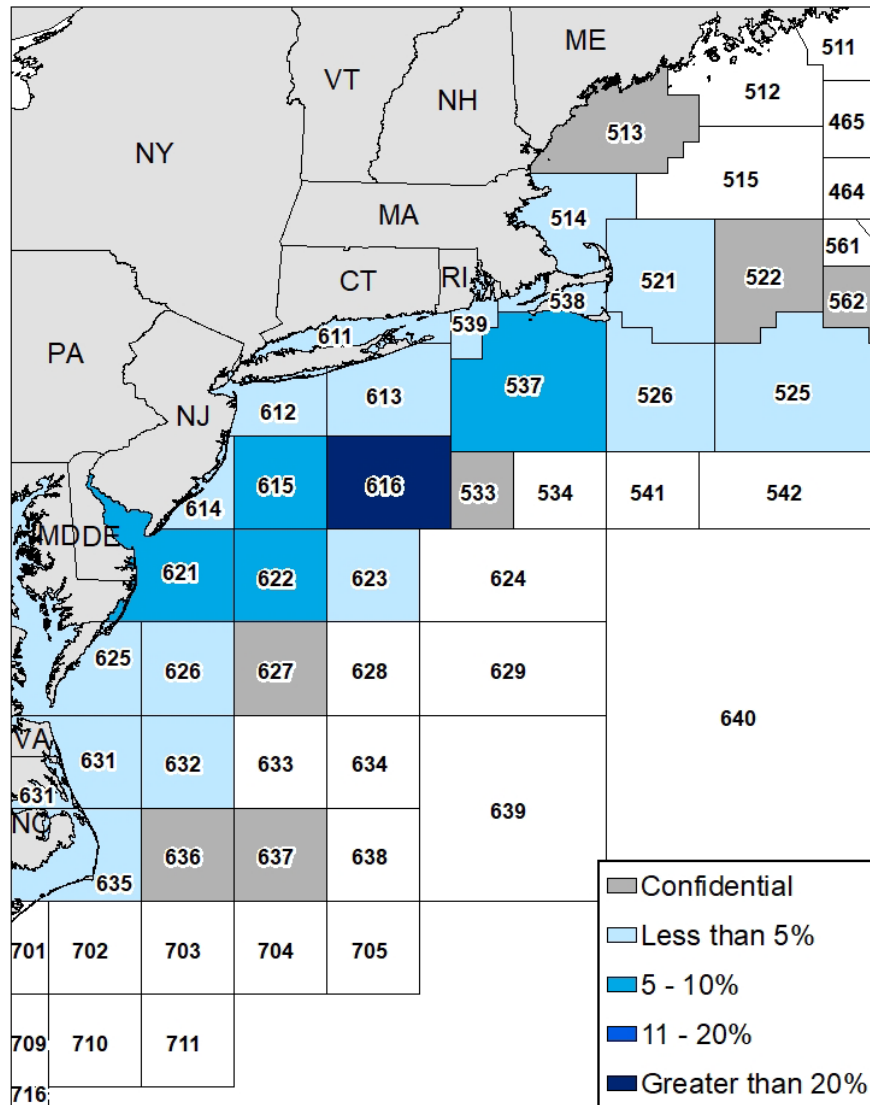
DRAFT AMENDMENT FOR PUBLIC COMMENT

At least 100,000 pounds of black sea bass were landed in each of 10 ports in 7 states from Maine through North Carolina in 2019. These 10 ports collectively accounted for over 66% of all commercial black sea bass landings in 2019 (Table 17).

**Table 17. Ports reporting at least 100,000 pounds of commercial black sea bass landings in 2019, based on dealer data.**

Port	Black Sea Bass Landings (lb)	% of total commercial black sea bass landings	Number of vessels landing Black Sea Bass
POINT PLEASANT, NJ	395,691	11%	40
OCEAN CITY, MD	369,507	10%	8
POINT JUDITH, RI	284,176	8%	315
HAMPTON, VA	266,307	8%	32
NEW BEDFORD, MA	217,593	6%	192
NEWPORT NEWS, VA	188,542	5%	17
BEAUFORT, NC	163,148	5%	52
CAPE MAY, NJ	161,095	5%	32
MONTAUK, NY	159,324	5%	126
CHINCOTEAGUE, VA	113,229	3%	8

**2019 Commercial Black Sea Bass Catch - VTRs**



**Figure 23. Proportion of black sea bass catch by statistical area in 2019 based on federal VTR data. Statistical areas marked “confidential” are associated with fewer than three vessels and/or dealers. Statistical areas with confidential data collectively accounted for less than 1% of commercial catch reported on VTRs in 2019. The amount of catch that was not reported on federal VTRs (e.g., catch from vessels permitted to fish only in state waters) is unknown. Northeast Fisheries Science Center Data (“AA tables”) suggest that 20% of total commercial landings (state and federal) in 2019 were not associated with a statistical area reported on federal VTRs.**

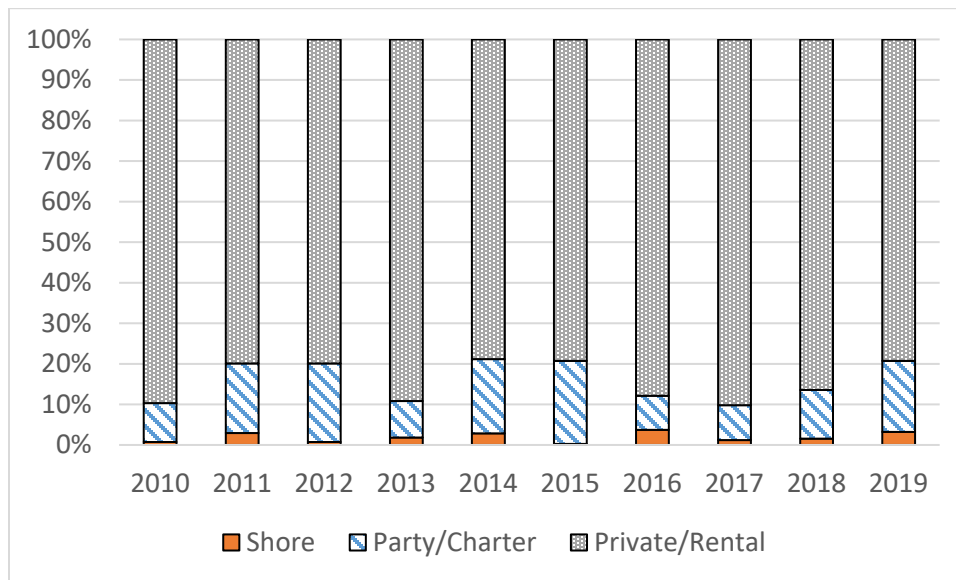
*Black Sea Bass Recreational Fishery*

Black sea bass are also an important recreational species in the Mid-Atlantic. Much of the annual fishing effort occurs during the period that sea bass are inshore (May to September), but season duration varies among the states. In 2018, recreational harvest estimates from MRIP were recalibrated based on the new Fishing Effort Survey. In general the recalibration resulted

DRAFT AMENDMENT FOR PUBLIC COMMENT

in higher harvest estimates throughout the time series, with more divergence in recent years. A more detailed description of the revisions to the MRIP sampling methodology may be found in section 1.1. The revised MRIP data is used in describing the characteristics of the scup recreational fishery in the sections below.

Between 1981 and 2019, recreational catch of black sea bass from Maine through North Carolina was lowest in 1984 at 5.67 million fish and was highest in 2017 at about 47.53 million fish (including live releases). Recreational harvest in weight was highest in 2016 at 12.35 million pounds; however, harvest in numbers of fish was highest in 1986 at 19.67 million fish. Recreational harvest in weight was lowest in 1998 at 1.93 million pounds, while harvest in numbers of fish was lowest in 1999 at 1.72 million fish. In 2019, an estimated 3.99 million black sea bass, at about 7.92 million pounds, were harvested by recreational anglers from Maine through Cape Hatteras, North Carolina (Table 18). From 2010-2019, an average of 84.1% of the harvest (in pounds) originated from private/rental boats, while party/charter boats and shore-based anglers accounted for an average of 1.9% and 14.0% of the harvest, respectively (Figure 24). Recreational dead discard estimates ranged from a low of 0.22 million pounds in 1989 to a high of 3.60 million pounds in 2017. Recreational dead discards averaged 14% of total catch from 2010 to 2019



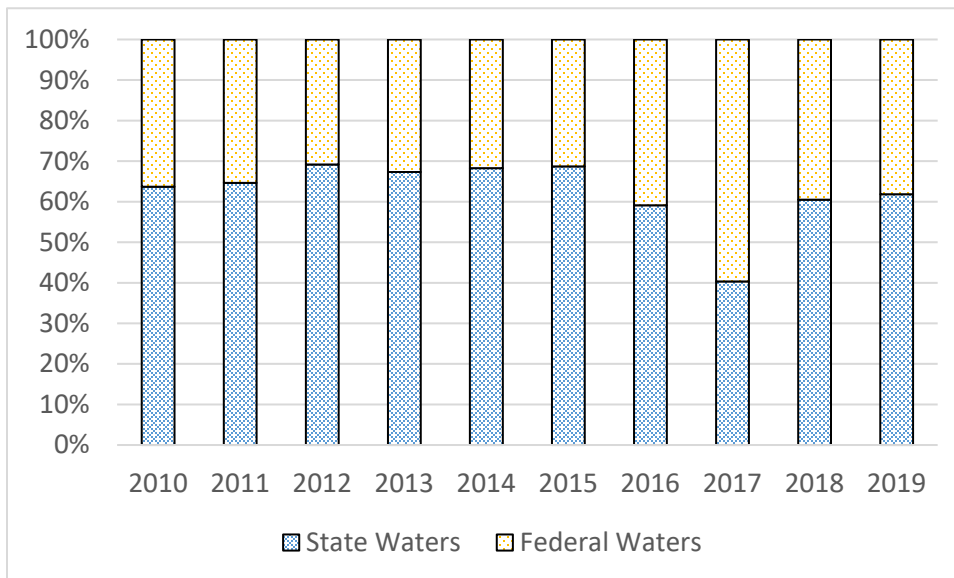
**Figure 24. The percent of black sea bass harvested by recreational fishing mode in numbers of fish, Maine through North Carolina, 2010-2019. Source: Personal Communication with the National Marine Fisheries Service, Fisheries Statistics Division, May 12, 2020**

**Table 18. Recreational black sea bass landings, catch, and mean weight of landed fish, Maine through North Carolina, 1981-2019. Source: MRIP**

Year	Catch (number of fish)	Landings (number of fish)	Landings (lbs)	Mean weight of landed fish (lb)
1981	10,302,297	3,431,735	2,101,224	0.61
1982	13,387,625	11,172,192	10,614,787	0.95
1983	9,782,212	5,852,690	5,136,992	0.88
1984	5,666,970	3,223,548	2,378,035	0.74
1985	10,827,931	5,556,972	4,180,036	0.75
1986	30,233,919	19,672,311	11,191,393	0.57
1987	6,415,842	3,084,164	2,177,825	0.71
1988	11,148,291	3,957,287	3,824,173	0.97
1989	12,568,892	7,264,555	5,770,697	0.79
1990	15,044,918	5,563,473	4,240,333	0.76
1991	16,014,778	6,420,550	5,007,585	0.78
1992	12,671,353	5,077,594	4,033,773	0.79
1993	13,081,089	7,439,497	5,881,426	0.79
1994	11,945,280	4,513,083	4,059,122	0.90
1995	19,991,850	7,101,638	5,435,419	0.77
1996	14,681,726	7,443,460	8,184,951	1.10
1997	16,631,810	6,826,489	6,563,226	0.96
1998	9,596,727	1,768,093	1,925,754	1.09
1999	15,506,801	1,719,090	2,220,080	1.29
2000	27,439,329	4,579,718	5,020,838	1.10
2001	22,514,133	4,631,814	6,645,254	1.43
2002	25,876,540	4,718,719	5,856,317	1.24
2003	19,463,038	4,383,299	5,970,617	1.36
2004	15,264,498	2,893,098	3,596,833	1.24
2005	14,770,461	2,347,314	3,653,133	1.56
2006	15,031,996	1,968,384	2,911,422	1.48
2007	16,059,303	2,272,546	3,582,800	1.58
2008	24,912,855	2,535,234	3,678,813	1.45
2009	24,409,019	4,065,964	5,857,509	1.44
2010	28,603,690	5,269,060	8,280,833	1.57
2011	14,883,578	1,889,204	3,422,046	1.81
2012	39,318,647	3,820,688	7,260,011	1.90
2013	28,744,942	3,095,095	5,791,445	1.87
2014	29,149,400	4,306,700	7,803,267	1.81
2015	29,314,181	5,258,234	9,505,659	1.81
2016	41,417,483	6,034,786	12,349,074	2.05
2017	47,525,605	5,997,390	12,007,504	2.00
2018	27,197,564	4,072,017	8,027,770	1.97
2019	35,113,323	4,523,214	8,821,559	1.95

DRAFT AMENDMENT FOR PUBLIC COMMENT

In 2019, 62% of black sea bass harvested by recreational fishermen (in numbers of fish) were caught in state waters and about 38% in federal waters (Figure 25). Most of the recreational harvest in 2019 was landed in New York (34.9%), New Jersey (18.4%), Massachusetts (11.6%), Rhode Island (11.4%), and Connecticut (11.4%; Table 19).



**Figure 25. Estimated percentage of black sea bass recreational landings (numbers of fish) in state vs. federal waters, Maine through North Carolina, 2010-2019. Source: Personal Communication with the National Marine Fisheries Service, Fisheries Statistics Division, November 19, 2020**

**Table 19. State contribution (as a percentage) to total recreational landings of black sea bass (in numbers of fish), from Maine through North Carolina, 2017-2019. Source: Personal Communication with the National Marine Fisheries Service, Fisheries Statistics Division, November 19, 2020**

State	2017	2018	2019	Avg 2017-2019
Maine	0.0%	0.0%	0.0%	0.0%
New Hampshire	0.0%	0.0%	0.0%	0.0%
Massachusetts	9.5%	16.7%	11.6%	12.6%
Rhode Island	5.5%	17.3%	11.4%	11.4%
Connecticut	8.2%	9.3%	11.4%	9.6%
New York	40.6%	21.0%	34.9%	32.1%
New Jersey	25.0%	25.5%	18.4%	23.0%
Delaware	1.9%	2.2%	1.0%	1.7%
Maryland	2.5%	3.8%	2.9%	3.0%
Virginia	1.6%	2.1%	5.1%	3.0%
North Carolina	5.3%	2.1%	3.4%	3.6%
Total	100.0%	100.0%	100.0%	100.0%

#### **1.3.4 Interactions with Other Fisheries**

Non-target species are those species caught incidentally while targeting other species, in this case, while targeting summer flounder, scup, or black sea bass. Some non-target species are occasionally retained, others are commonly discarded. This section describes the non-target species commonly caught in the commercial and recreational summer flounder, scup, and black sea bass fisheries and summarizes their management status and stock status.

##### *Identification of Major Non-Target Species*

It can be difficult to develop accurate quantitative estimates of catch of non-target species. The intended target species for any given tow or set is not always obvious. Fishermen may intend to target one or multiple species and the intended target species may change mid-trip. For example, the seasonal distributions of summer flounder, scup, and black sea bass are generally similar, and these species are often caught together. In some circumstances, scup can be a non-target species in the black sea bass fishery and vice versa. It is not always clear from the data which species is the primary target, which is a secondary target, and which species are not targeted but are landed if caught incidentally.

In addition, there are limitations to the data used to examine catch and discards (i.e., observer and VTR data). Observer data are available only for commercial fisheries and may not be representative of all fishing activity due to limited coverage and potential differences in behavior when observers are present. VTR data are available for commercial and for-hire fisheries. VTR data can be uncertain as they are based on the harvester's self-reported best estimates of catch, which are not intended to be precise measurements. MRIP is the only source of recreational catch and discard data for private recreational anglers participating in the summer flounder, scup, and black sea bass fisheries. For these reasons, a combination of quantitative and qualitative data were used here to identify relevant non-target species.

Northeast Fisheries Observer Program data from 2015-2019 were analyzed to identify species caught on observed commercial trips for which summer flounder, scup, or black sea bass made up at least 75% of the landings (by weight; a proxy for directed trips). Using this definition of a non-target species, the most common non-target species in the summer flounder fishery include little skate, spiny dogfish, clearnose skate, winter skate, Northern sea robin, barndoor skate, and black sea bass. The most common non-target species in the scup fishery include spiny dogfish, little skate, northern sea robin, black sea bass, and summer flounder. The most common non-target species in the black sea bass fishery include sea robins (striped, northern, and unknown), spiny dogfish, scup, and little skate. With the exception of spiny dogfish and striped sea robin, non-target species typically comprised a small portion (<10%) of the overall catch on these trips. All of these species, with the exception of the sea robins, are managed by the Mid-Atlantic or New England Fishery Management Councils and/or the Commission. Northern and striped sea robins are not managed.

A species guild approach was used to examine non-target species interactions in the recreational summer flounder, scup, and black sea bass fisheries from Maine through Virginia. This analysis identified species that were caught together on 5% or more of recreational trips.



## DRAFT AMENDMENT FOR PUBLIC COMMENT

Sea robins, black sea bass, and bluefish were highly correlated with summer flounder in the recreational fishery (J. Brust, personal communication January 2018). Black sea bass, sea robins, tautog, cunner, bluefish, summer flounder, and smooth dogfish were highly correlated with recreational scup catch (J. Brust, personal communication April 2019). Scup, summer flounder, sea robins, Atlantic croaker, and tautog were highly correlated with black sea bass recreational catch (NEFSC 2017).

### *Description and Status of Major Non-Target Species*

The stock status and management status of the non-target species identified above are briefly described below. Management measures for the Mid-Atlantic and New England Fishery Management Council-managed species (skates, spiny dogfish, black sea bass, and scup) include Accountability Measures (AMs) to address Annual Catch Limit (ACL) overages through reductions in landings limits in following years. AMs for all of these species take discards into account and help to mitigate negative impacts from discards in these and other recreational fisheries. As indicated above, summer flounder, scup, and black sea bass are often caught together and, for some commercial and recreational trips, one or two of these species could be considered non-target species of the other. None of these three stocks are currently overfished or undergoing overfishing, and stock status is described in sections 1.2.1 through 1.2.3.

#### Spiny Dogfish

Spiny dogfish (*Squalus acanthias*) is a coastal shark with populations on the continental shelves of northern and southern temperate zones throughout the world. It is the most common shark in the western north Atlantic and ranges from Labrador to Florida, but it is found in greatest abundance from Nova Scotia to Cape Hatteras, North Carolina. Its major migrations on the northwest Atlantic shelf are north and south, but it also migrates inshore and offshore seasonally in response to changes in water temperature. Spiny dogfish are jointly managed by the MAFMC and the NEFMC; the Commission also has a complementary FMP for state waters.

Spiny dogfish have a long life, late maturation, a long gestation period, and relatively low fecundity, making them generally vulnerable to depletion. Fish, squid, and ctenophores dominate the stomach contents of spiny dogfish collected during the NEFSC bottom trawl surveys but they are opportunistic and have been found to consume a wide variety of prey. More detailed life history information can be found in the EFH source document for spiny dogfish at: <http://www.nefsc.noaa.gov/publications/tm/tm203/tm203.pdf>. The 2018 Stock Assessment Update indicates the population is not overfished nor experiencing overfishing. The spawning stock biomass estimate of 235 million pounds is above the SSB threshold of 175 million pounds, while the fishing mortality estimate (0.202) is just below the fishing mortality threshold (0.2439). Despite remaining above the threshold, biomass has declined in recent years, requiring a significant reduction in 2019-2020 to ensure that overfishing does not occur (NEFSC 2018).

#### Smooth Dogfish

Smooth dogfish are jointly managed by the Commission as a part of the Atlantic Coastal Sharks management plan and NOAA Fisheries as a part of the Atlantic Shark Highly Migratory Species

## DRAFT AMENDMENT FOR PUBLIC COMMENT

management plan. According to the most recent assessment, the stock is not overfished and overfishing is not occurring (SEDAR 2015).

### Northeast Skate

The Northeast skate complex includes seven skate species: *Leucoraja ocellata* (winter skate); *Dipturus laevis* (barndoor skate); *Amblyraja radiata* (thorny skate); *Malacoraja senta* (smooth skate); *Leucoraja erinacea* (little skate); *Raja eglanteria* (clearnose skate); and *Leucoraja garmani* (rosette skate). Little skates are the main skate species identified as non-target species in the scup and black sea bass fisheries. Skate are mostly harvested incidentally in trawl and gillnet fisheries targeting groundfish, monkfish, and scallops. The fishing mortality reference points for skates are based on changes in biomass indices from the NEFSC bottom trawl survey. If the three-year moving average of the survey biomass index for a skate species declines by more than the average CV of the survey time series, then fishing mortality is assumed to be greater than FMSY and it is concluded that overfishing is occurring (NEFMC 2018). None of the skate species identified as non-target species in the commercial scup and black sea bass fisheries (i.e., little, clearnose, barndoor, and winter skates) are overfished or experiencing overfishing (NEFMC 2018).

### Northern Sea Robin

Northern sea robins (*Prionotus carolinus*) and striped sea robins (*Prionotus evolans*) have not been assessed, therefore their stock status and overfishing status is unknown. Sea robins are not managed directly at the federal or state level. Northern sea robins are distributed from Nova Scotia to central Florida, and are most common between Cape Cod, MA and Cape Hatteras, NC. Sea robins typically inhabit coastal waters over open sand or mud from near shore to depths of about 170 meters, and undertake southerly/offshore migrations in the winter (Gilbert and Williams 2002).

### Bluefish

Bluefish are jointly managed by the MAFMC and the Commission. The most recent operational assessment results indicated that the bluefish stock was overfished and overfishing was not occurring in 2018 relative to the biological reference points. Fishing mortality on the fully selected age 2 fish was 0.146 in 2018, 80% of the updated fishing mortality threshold reference point FMSY proxy = F35% = 0.183. There is a 90% probability that the fishing mortality rate in 2018 was between 0.119 and 0.205 (NEFSC 2019b).

### Atlantic Croaker

Atlantic croaker are managed by the Commission. The latest stock assessment was not endorsed by an independent panel of fisheries scientists for management use; however, the panel agreed with the general results of the assessment. The panel recommended continued use of the annual "traffic light analysis" (TLA) established in 2014 to monitor fishery and resource trends, and implement management measures as needed. This analysis assigns a color (red, yellow, or green) to categorize relative levels of indicators of the condition of the fish population (abundance metric) or fishery (harvest metric). For example, as harvest increases relative to its long-term mean, the proportion of green in a given year will increase and as harvest decreases, the amount of red in that year will increase. Under the Atlantic croaker FMP,

## DRAFT AMENDMENT FOR PUBLIC COMMENT

state-specific management action would be initiated when the proportion of red exceeds the specified thresholds (for both harvest and abundance) over three consecutive years. A key issue causing uncertainty in the assessment results was the disagreement between recent trends in harvest and fishery independent indices of abundance. Recent harvest numbers are declining while estimated abundance from fishery independent surveys is increasing in some regions. In 2020 the TLA harvest and overall abundance composite's sustained downward trend triggered a management response in the northern Atlantic region (ASMFC 2017; ASMFC 2020).

### Tautog

Tautog are managed by the Commission. The latest assessment (ASMFC 2016) assessed four regions (Massachusetts/Rhode Island, Long Island Sound, New Jersey/New York Bight, and Delaware/Maryland/Virginia) using landings and index data through 2015.

### Cunner

Ranging along the Atlantic coast and offshore banks of North America, cunner are regular residents from Newfoundland to New Jersey and are occasionally found as far south as the mouth of the Chesapeake Bay. Recreational anglers most often catch cunner around piers, rock jetties and eel grass beds. Cunner are not currently managed and have not been assessed, therefore their stock status and overfishing status is unknown.

### **1.3.5 Catch vs. Landings-Based Allocations**

This section provides additional clarification on the differences between catch and landings-based allocations. These allocations are used to derive a set of required annual catch and landings limits for both sectors, including commercial and recreational annual catch limits and annual catch targets (ACLs and ACTs<sup>6</sup>, which both account for landings and dead discards), and landings limits (commercial quota and RHL, both of which only account for landings). The same types of catch and landings limits are all required under both catch and landings-based allocations. These limits are calculated through the annual specifications process. The commercial/recreational allocations are not used in other parts of the management process; they are only used in the specifications process to derive the sector-specific catch and landings limits.

In both cases, all catch and landings limits are derived from the overall ABC, which applies to all dead catch and is set based on the best scientific information available. The main difference between catch and landings-based allocations is the step in the process at which the commercial/recreational allocation is applied and how dead discards are factored into the calculations.

A **catch-based** allocation distributes the total ABC (which accounts for both landings and dead discards) between the two sectors as commercial and recreational ACLs, based on the allocation percentages defined in the FMP (catch-based step 1 in the figures below). Dead discards are then estimated for each sector and subtracted from the sector ACLs to derive the annual sector landings limits (commercial quota and RHL).

A **landings-based** allocation applies the allocation percentage defined in the FMP to only the portion of the ABC that is expected to be landed (landings-based steps 1 and 2 in the figures below). This requires first calculating the amount of expected dead discards from both sectors combined and subtracting that from the ABC (landings-based step 1), so that the allocation percentage can be applied to the total allowable landings (landings-based step 2). Dead discards are still projected for each sector and incorporated into the ACLs under a landings-based allocation, but the process is more complex due to the need to separate out total landings first to apply the allocation. This process evolved because management of summer flounder and black sea bass was previously based on landings limits only and did not consider dead discards. When dead discards were first incorporated into management, the allocation percentages continued to be applied to landings only and it was determined other methods were needed to split expected dead discards by sector.

As described in more detail below, in both cases, sector-specific dead discards are generally estimated based on recent trends in the fisheries. Therefore, **under a landings-based allocation, recent trends in dead discards in one sector have more of an impact on the catch and landings limits in the other sector. Under a catch-based allocation, the calculations of sector-specific catch and landings limits are more separate and recent trends in landings and dead discards in one sector have a lesser impact on the limits in the other sector.** This can have important implications due to sector-specific differences in factors such as how landings and discards are estimated, the factors influencing discards (e.g., regulations, market demand, catch and release practices), and discard mortality rates.

Under both allocation approaches, the commercial/recreational allocation percentages are fixed (until modified through an FMP action) and do not vary based on recent trends in the fisheries. They would be defined based on one of the alternatives listed in Section 4.0 of this document.

More details, including a description of the subsequent steps to arrive at the commercial quota and RHL are included below. Examples of the implications of each approach are included at the end of this section.

#### **Projected Discards Under Both Allocation Approaches**

For scup and summer flounder, the total amount of the ABC expected to come from dead discards can be projected using the stock assessment model. These projections account for variations in the size of different year classes (i.e., the fish spawned in a given year) and catch at age information from the commercial and recreational sectors. The current stock assessment model for black sea bass does not allow for these projections, so alternative methods such as recent year average proportions need to be used.

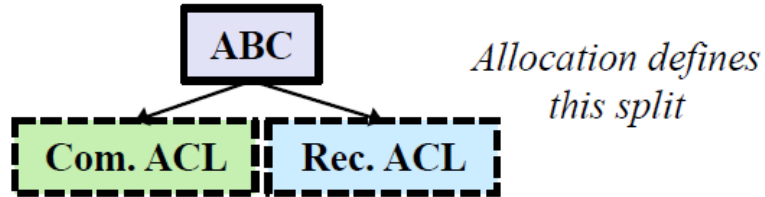
Regardless of the allocation approach, the methodology for calculating sector-specific dead discards (as opposed to total dead discards) is not defined in the FMP and can vary based on annual considerations. The Monitoring Committee provides advice on this decision.

Under both approaches, only **dead** discards are factored into the allocation percentages and the catch and landings limits calculations. Discarded fish which are presumed to survive do not factor into these calculations.

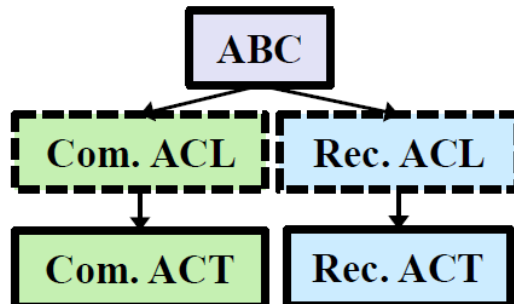
*Catch-based Allocation Process*

The proposed allocation percentage alternatives are listed in Section 4.1. Each alternative is then used in the specifications process as described below.

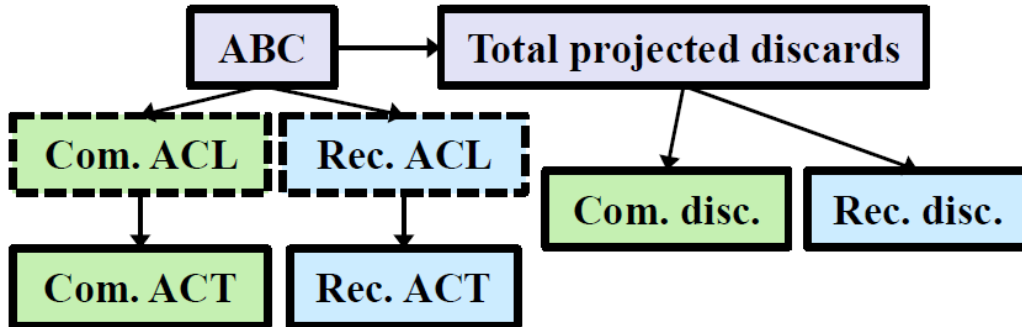
**Catch-based Step 1.** The ABC is divided into commercial and recreational ACLs based on the allocation percentages defined in the FMP.



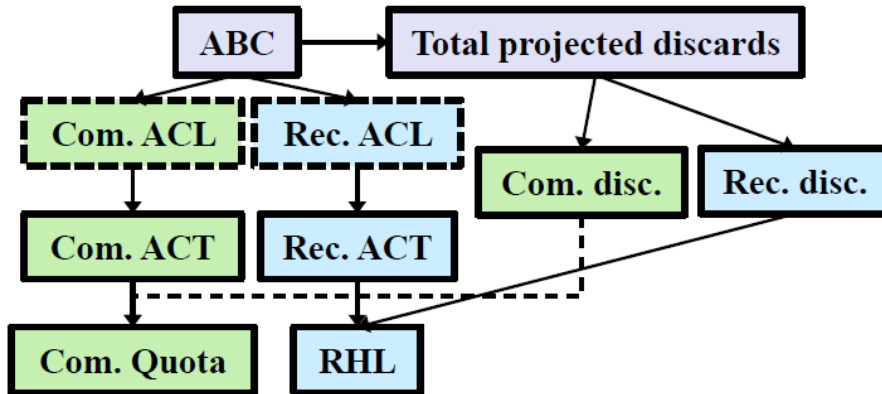
**Catch-based Step 2.** Commercial and recreational ACTs are set less than or equal to their respective ACLs to account for management uncertainty. The appropriate deduction for management uncertainty (if any) is not pre-defined and is based on annual considerations, including the advice of the Monitoring Committee.



**Catch-based Step 3.** Expected dead discards are calculated for each sector to derive the commercial quota and RHL from the sector-specific ACTs.



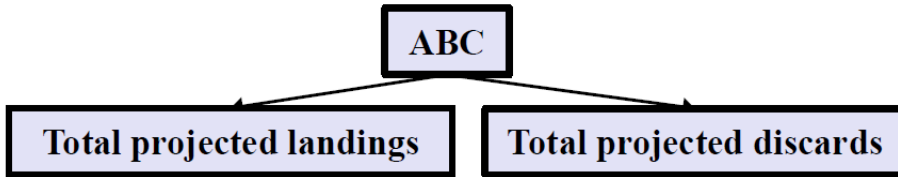
**Catch-based Step 4.** Commercial quotas and RHLs are determined by subtracting the sector-specific dead discards (see catch-based step 3) from the sector-specific ACTs.



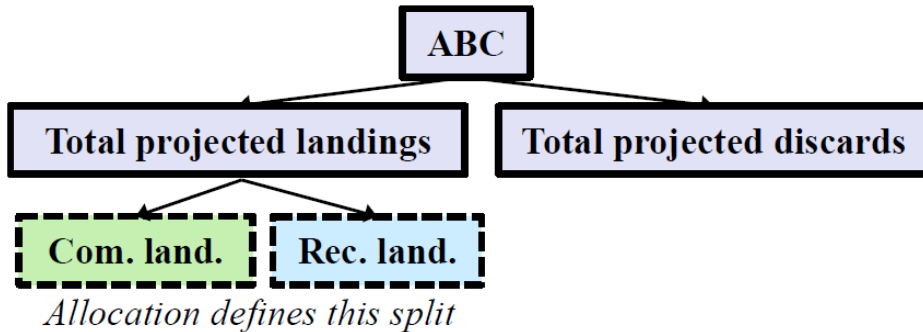
*Landings-Based Allocation Process*

**Landings-based Step 1.** The ABC is first divided into the amount expected to come from landings (total projected landings) and the amount expected to come from dead discards (total projected dead discards). The methodology for this calculation is not defined in the FMP and can vary based on annual considerations. The Monitoring Committee provides advice on this decision.

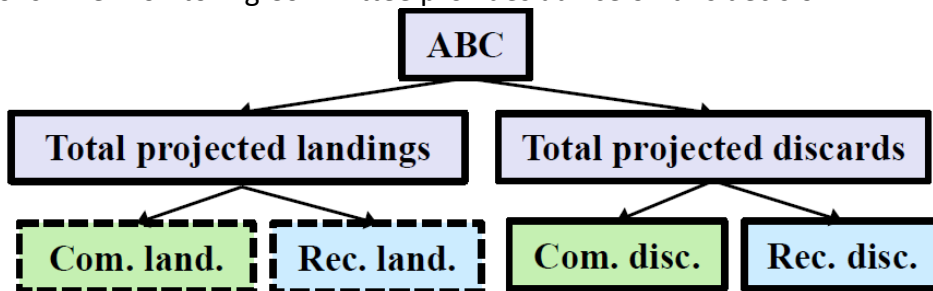
As previously stated, for scup and summer flounder, these calculations can be informed by stock assessment projections. The current black sea bass stock assessment does not model landings and dead discards separately; therefore, calculations of total projected landings and dead discards for black sea bass cannot be informed by stock assessment projections. Instead, other methods, such as those based on recent year average proportions, must be used.



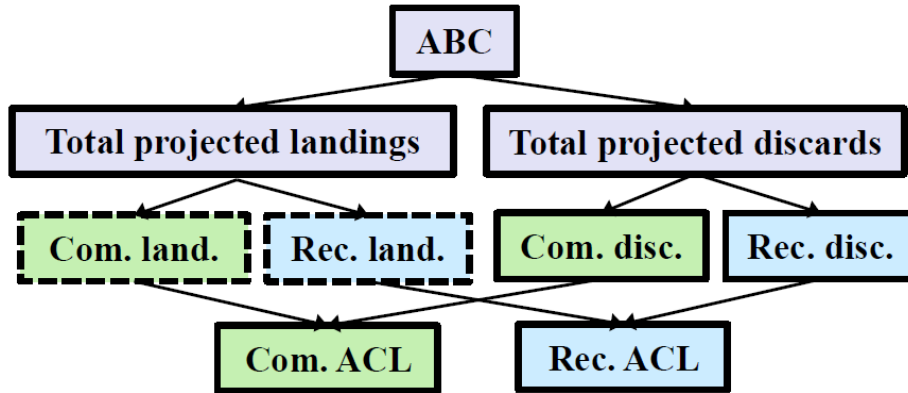
**Landings-based Step 2.** The total projected landings are allocated to the commercial and recreational sectors based on the allocation percentages defined in the FMP.



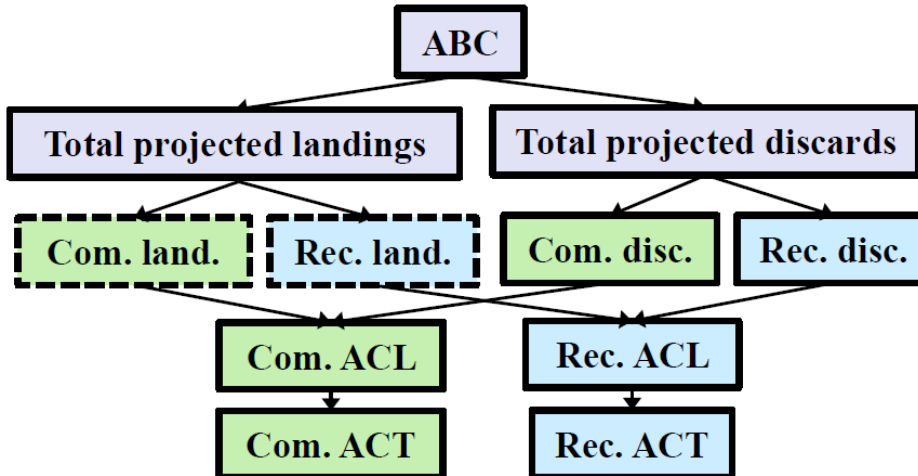
**Landings-based Step 3.** The total projected dead discards are split into projected commercial dead discards and projected recreational dead discards. The methodology for calculating sector-specific dead discards is not defined in the FMP and can vary based on annual considerations. The Monitoring Committee provides advice on this decision.



**Landings-based Step 4.** Commercial and recreational ACLs are calculated by adding the landings amount allocated to each sector and the sector-specific projected dead discards (see Steps 2 and 3 above).

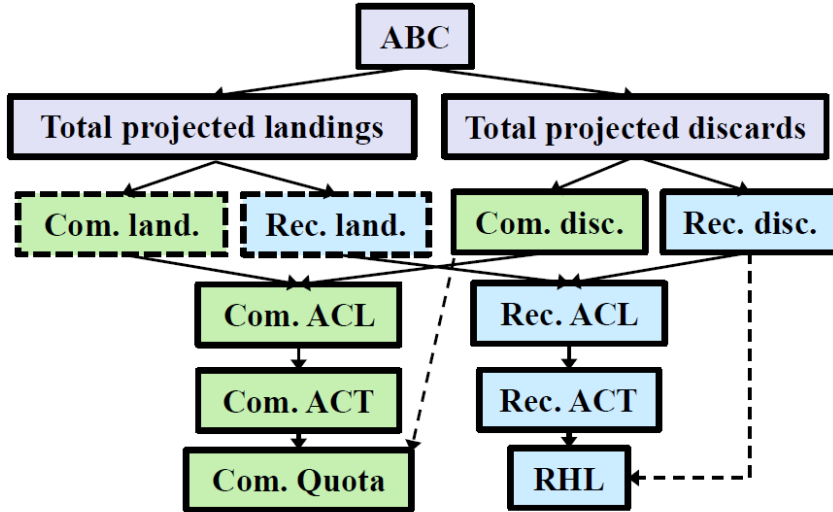


**Landings-based Step 5.** Commercial and recreational ACTs are set less than or equal to their respective ACLs to account for management uncertainty. The appropriate deduction for management uncertainty (if any) is not pre-defined and is based on annual considerations, including the advice of the Monitoring Committee.



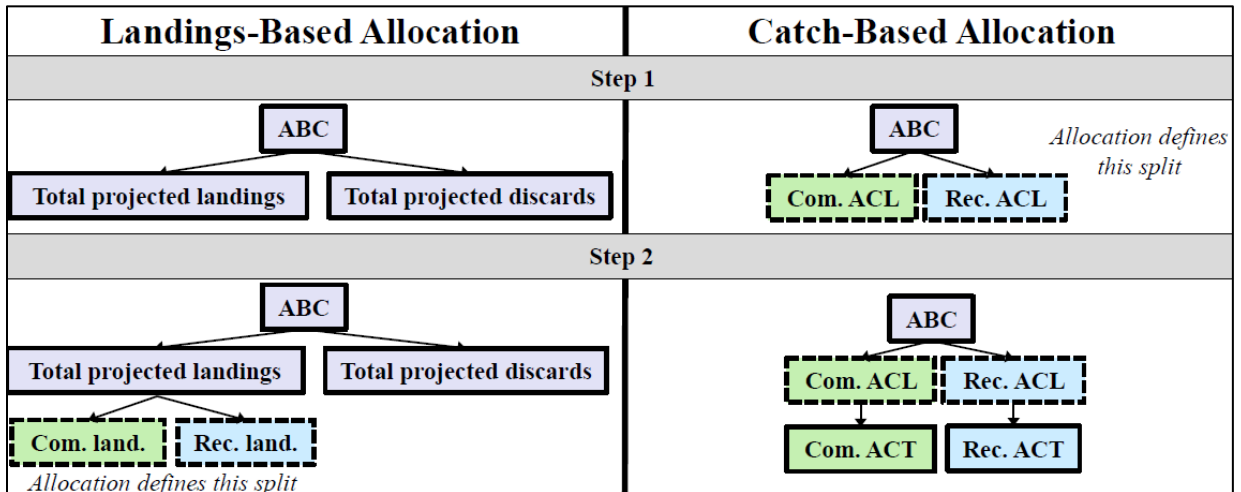


**Landings-based Step 6.** Commercial quotas and RHLs are determined by subtracting sector-specific discards from the sector-specific ACTs.



*Implications of Catch vs. Landings-Based Allocation Approaches*

One of the major differences between catch-based and landings-based allocations is at which step in the process the commercial/recreational allocation is applied to derive catch and landings limits. Under a catch-based allocation, the commercial/recreational allocation is applied in the first step of the process after the ABC is determined. Under a landings-based allocation, decisions about the total amount of expected landings and dead discards must be made before the commercial/ recreational allocation is applied. The commercial/recreational allocation is then applied to the total amount of expected landings (Figure 26).



**Figure 26.** Comparison of first two steps of calculating commercial and recreational catch and landings limits under catch and landings-based allocations.

The method for determining total expected landings and dead discards under a landings-based approach is not specified in the FMP and can vary based on annual considerations. In practice, this typically involves consideration of stock assessment projections and/or recent trends in landings and dead discards, depending on the species. In this way, considerations of recent trends in the stock and discard trends in either the commercial or recreational fishery impacts both sector's catch and landings limit under a landings-based allocation to a greater extent than under a catch-based allocation.

Under a catch-based allocation, the total ABC is always allocated among the commercial and recreational sectors in the same way (i.e., based on the allocation percentages defined in the FMP) regardless of recent trends in year classes or landings and dead discards in each sector. Put another way, under a catch-based allocation, changes in landings and dead discards in one sector do not influence the other sector's ACL as the entire ABC is always split among the sectors based on the allocation defined in the FMP, regardless of recent trends in landings and discards by sector. In theory, this can allow each sector to see the benefits of a reduction in their own dead discards to a greater extent than under a landings-based allocation. Under a catch-based allocation, a reduction in dead discards in one sector can result in an increase in that sector's landings limit in a future year. This was part of the rationale for implementing the current catch-based allocation for scup as it was expected to incentivize a reduction in commercial dead discards, which were of concern during development of Amendment 8. Under a landings-based allocation, changes in landings and dead discards in one sector can influence the catch and landings limits in both sectors; therefore, the benefits of a reduction in dead discards (or the negative impacts of an increase in dead discards) in one sector can also be felt by the other sector.

Although catch- and landings-based allocations may create different incentives for reducing dead discards in each sector, in reality, this may be a long-term impact. With the exception of the no action alternatives, all the proposed allocation alternatives are based on historical patterns in the fisheries considering the best available recreational and commercial data, either using the original base years or considering data through 2018 or 2019, depending on the alternative (Section 4.1). Therefore, the catch or landings-based allocations under many of the alternatives may not create an immediate notable incentive for change compared to recent operating conditions. Selection of catch versus landings-based allocations does have an immediate effect on each sector's landings limit. Appendix II presents a methodology for projecting landings limits under the catch- and landings-based allocation alternatives, and Section 4.1 compares recent trends in landings data to the projected landings limits under each allocation alternative.

## **1.4 HABITAT CONSIDERATIONS**

### **1.4.1 Description of Physical Habitat**

Summer flounder, scup, and black sea bass inhabit the northeast U.S. shelf ecosystem, which extends from the coast to the edge of the continental shelf from the Gulf of Maine through Cape Hatteras, including the slope sea offshore to the Gulf Stream. The northeast shelf ecosystem includes the Gulf of Maine, Georges Bank, the Mid-Atlantic Bight, and the continental slope (Figure 27).

## DRAFT AMENDMENT FOR PUBLIC COMMENT

The Gulf of Maine is a semi-enclosed coastal sea, characterized by relatively cold waters and deep basins, with a patchwork of various sediment types. Georges Bank is a relatively shallow coastal plateau that slopes gently from north to south and has steep submarine canyons on its eastern and southeastern edge. It is characterized by highly productive, well-mixed waters and strong currents. The Mid-Atlantic Bight is comprised of the sandy, relatively flat, gently sloping continental shelf from southern New England to Cape Hatteras, North Carolina.

The continental slope begins at the continental shelf break and continues eastward with increasing depth until it becomes the continental rise. It is fairly homogenous, with exceptions at the shelf break, some canyons, the Hudson Shelf Valley, and in areas of glacially rafted hard bottom.

The continental shelf in this region was shaped largely by sea level fluctuations caused by past ice ages. The shelf's basic morphology and sediments derive from the retreat of the last ice sheet and the subsequent rise in sea level. Currents and waves have since modified this basic structure. Shelf and slope waters of the Mid-Atlantic Bight have a slow southwestward flow that is occasionally interrupted by warm core rings or meanders from the Gulf Stream. On average, shelf water moves parallel to bathymetry isobars at speeds of 5 - 10 cm/s at the surface and 2 cm/s or less at the bottom. Storm events can cause much more energetic variations in flow. Tidal currents on the inner shelf have a higher flow rate of 20 cm/s that increases to 100 cm/s near inlets.

The shelf slopes gently from shore out to between 100 and 200 km offshore where it transforms to the slope (100 - 200 m water depth) at the shelf break. Numerous canyons incise the slope and some cut up onto the shelf itself. The primary morphological features of the shelf include shelf valleys and channels, shoal massifs, scarps, and sand ridges and swales. Most of these structures are relic except for some sand ridges and smaller sand-formed features. Shelf valleys and slope canyons were formed by rivers of glacier outwash that deposited sediments on the outer shelf edge as they entered the ocean. Most valleys cut about 10 m into the shelf; however, the Hudson Shelf Valley is about 35 m deep. The valleys were partially filled as the glacier melted and retreated across the shelf. The glacier also left behind a lengthy scarp near the shelf break from Chesapeake Bay north to the eastern end of Long Island. Shoal retreat massifs were produced by extensive deposition at a cape or estuary mouth. Massifs were also formed as estuaries retreated across the shelf.

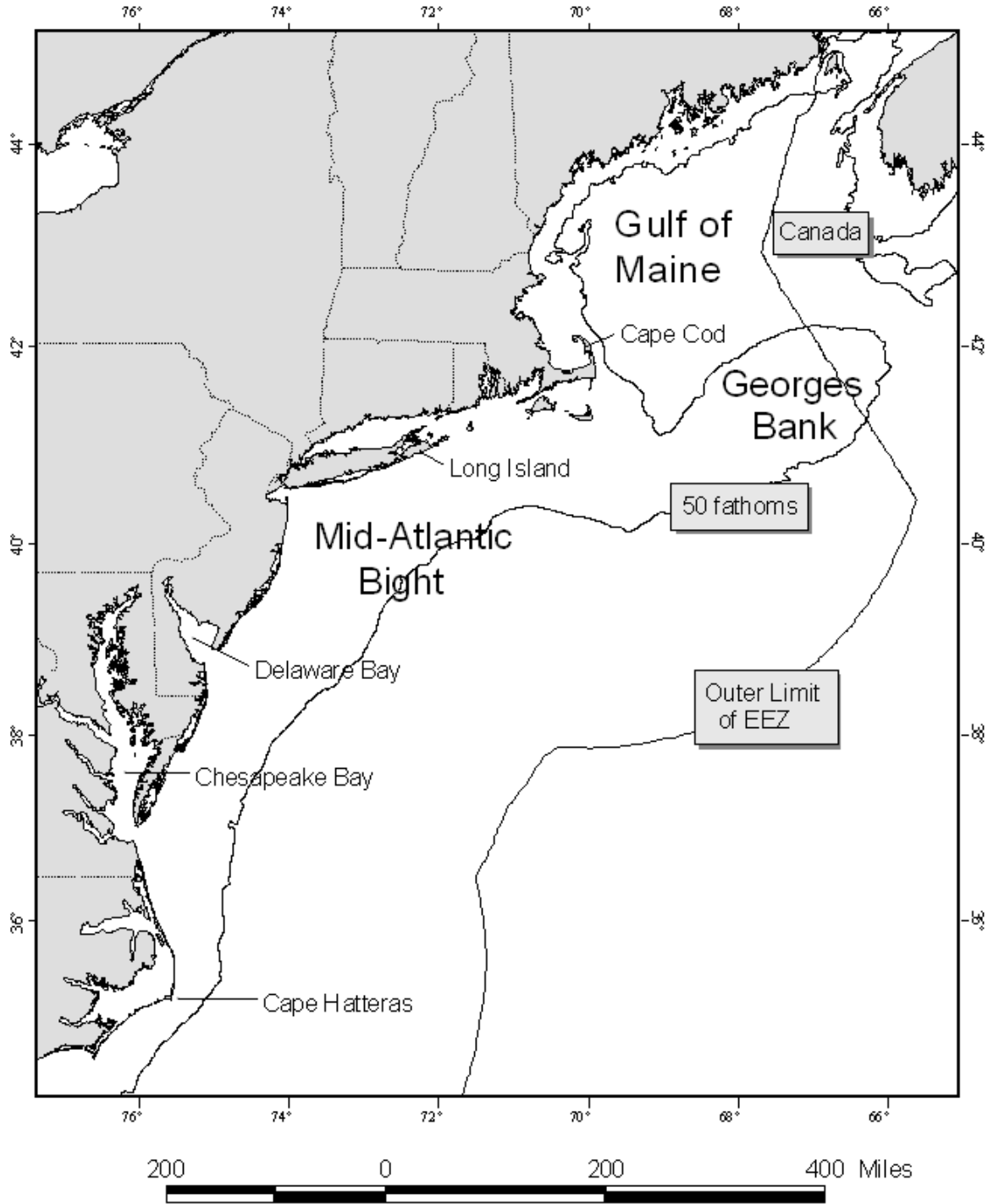


Figure 27. Northeast U.S. Shelf Ecosystem.

## DRAFT AMENDMENT FOR PUBLIC COMMENT

Some sand ridges are more modern in origin than the shelf's glaciated morphology. Their formation is not well understood; however, they appear to develop from the sediments that erode from the shore face. They maintain their shape, so it is assumed that they are in equilibrium with modern current and storm regimes. They are usually grouped, with heights of about 10 m, lengths of 10 - 50 km and spacing of 2 km. Ridges are usually oriented at a slight angle towards shore, running in length from northeast to southwest. The seaward face usually has the steepest slope. Sand ridges are often covered with smaller similar forms such as sand waves, megaripples, and ripples. Swales occur between sand ridges. Since ridges are higher than the adjacent swales, they are exposed to more energy from water currents and experience more sediment mobility than swales. Ridges tend to contain less fine sand, silt and clay while relatively sheltered swales contain more of the finer particles. Swales have greater benthic macrofaunal density, species richness and biomass, due in part to the increased abundance of detrital food and the less physically rigorous conditions.

Sand waves are usually found in patches of 5 - 10 with heights of about 2 m, lengths of 50 - 100 m and 1 - 2 km between patches. Sand waves are primarily found on the inner shelf, and often observed on sides of sand ridges. They may remain intact over several seasons. Megaripples occur on sand waves or separately on the inner or central shelf. During the winter storm season, they may cover as much as 15% of the inner shelf. They tend to form in large patches and usually have lengths of 3 - 5 m with heights of 0.5 - 1 m. Megaripples tend to survive for less than a season. They can form during a storm and reshape the upper 50 - 100 cm of the sediments within a few hours. Ripples are also found everywhere on the shelf and appear or disappear within hours or days, depending upon storms and currents. Ripples usually have lengths of about 1 - 150 cm and heights of a few centimeters.

Sediments are uniformly distributed over the shelf in this region. A sheet of sand and gravel varying in thickness from 0 - 10 m covers most of the shelf. The mean bottom flow from the constant southwesterly current is not fast enough to move sand, so sediment transport must be episodic. Net sediment movement is in the same southwesterly direction as the current. The sands are mostly medium to coarse grains, with finer sand in the Hudson Shelf Valley and on the outer shelf. Mud is rare over most of the shelf, but is common in the Hudson Shelf Valley. Occasionally relic estuarine mud deposits are re-exposed in the swales between sand ridges. Fine sediment content increases rapidly at the shelf break, which is sometimes called the "mud line," and sediments are 70 - 100% fine on the slope. On the slope, silty sand, silt, and clay predominate (Stevenson et al. 2004).

Greene et al. (2010) identified and described Ecological Marine Units (EMUs) in New England and the Mid-Atlantic based on sediment type, seabed form (a combination of slope and relative depth)<sup>4</sup>, and benthic organisms.<sup>5</sup> According to this classification scheme, the sediment

---

<sup>4</sup> Seabed form contains the categories of depression, mid flat, high flat, low slope, side slope, high slope, and steep slope.

<sup>5</sup> See Greene et al. 2010 for a description of the methodology used to define EMUs.

composition off New England and the Mid-Atlantic is about 68% sand, 26% gravel, and 6% silt/mud. The seafloor is classified as about 52% flat, 26% depression, 19% slope, and 3% steep.

Artificial reefs are another significant Mid-Atlantic habitat. These localized areas of hard structure were formed by shipwrecks, lost cargoes, disposed solid materials, shoreline jetties and groins, submerged pipelines, cables, and other materials (Steimle and Zetlin 2000). While some of these materials were deposited specifically for use as fish habitat, most have an alternative primary purpose; however, they have all become an integral part of the coastal and shelf ecosystem. In general, reefs are important for attachment sites, shelter, and food for many species, and fish predators such as tunas may be attracted by prey aggregations, or may be behaviorally attracted to the reef structure.

Like all the world's oceans, the western North Atlantic is experiencing changes to the physical environment due to global climate change. These changes include warming temperatures; sea level rise; ocean acidification; changes in stream flow, ocean circulation, and sediment deposition; and increased frequency, intensity, and duration of extreme climate events. These changes in physical habitat can impact the metabolic rate and other biological processes of marine species. As such, these changes have implications for the distribution and productivity of many marine species. Several studies demonstrate that the distribution and productivity of several species in the Mid-Atlantic have changed over time, likely because of changes in physical habitat conditions such as temperature (e.g., Weinberg 2005, Lucey and Nye 2010, Nye et al. 2011, Pinsky et al. 2013, Gaichas et al. 2015).

#### **1.4.2 Environmental Requirements of Summer Flounder, Scup, and Black Sea Bass**

##### Summer Flounder

Summer flounder habitat includes pelagic waters, demersal waters, saltmarsh creeks, seagrass beds, mudflats, and open bay areas from the Gulf of Maine through North Carolina. The center of its abundance lies within the Middle Atlantic Bight from Cape Cod, Massachusetts, to Cape Hatteras, North Carolina. Summer flounder exhibit strong seasonal inshore-offshore movements, although their movements are often not as extensive as compared to other highly migratory species. Adult and juvenile summer flounder normally inhabit shallow coastal and estuarine waters during the warmer months of the year and remain offshore during the fall and winter.

Juvenile summer flounder have been shown to make use of several substrate types, including sand, shell, oyster bars, and mud, as well as transition areas between sand to silt/clay. Substrate preferences of juvenile summer flounder may be correlated to presence and types of predators and prey. Juveniles make extensive use of marsh creeks and other estuarine habitats. Other studies have shown that juvenile summer flounder also make use of vegetated habitats such as sea grass beds, as well as aggregations of macroalgae (Packer et al. 1999).

## DRAFT AMENDMENT FOR PUBLIC COMMENT

Adult summer flounder generally prefer sandy habitats, including areas of quartz sand, coarse sand, and shell, but can be found in a variety of habitats with both mud and sand substrates including marsh creeks, seagrass beds, and sand flats. As with juvenile summer flounder, adults are also known to utilize vegetation such as seagrass beds, where they are able to ambush prey and avoid predation (Packer et al. 1999).

### Scup

Scup habitat includes estuaries, demersal waters, mixed sand and mud substrate, eelgrass beds, mussel flats and other reef structures. Adult and juvenile scup habitat preference is highly dependent on season. During the warmer months, scup exhibit a strong preference for mixed sand and mud sediments (Gottschall et al. 2000), whereas the presence of structure can be important to scup in offshore, deeper habitat during the winter Auster *et al.* (1991, 1995). Scup spawn once a year along the inner continental shelf beginning in the spring during the inshore migration (Kendall 1973). Most spawning occurs over sandy and weed-covered bottom in southern New England from Massachusetts Bay south to the New York Bight, including eastern Long Island Sound, Peconic and Gardiners Bays, and Raritan Bay (Bigelow and Schroeder 1953; Wheatland 1956; Richards 1959; Finkelstein 1969; Sisson 1974; Morse 1978; Clayton *et al.* 1978).

During warmer months, juvenile scup live inshore in a variety of coastal habitats and can dominate the overall fish population in larger estuarine areas during that time of year. Juvenile scup may be found over a variety of substrates, but are most abundant over unstructured bottom and in depths ranging from 3 to 5 m (Able and Fahay 2010). Studies have shown that juveniles make use of biogenic depressions in the sediments off southern New England in the fall, and can use biogenic depressions, sand wave troughs, and possibly mollusk shell fields for shelter in winter Gray (1990) and Auster *et al.* (1991, 1995).

Adult scup prefer habitats that are similar to those used by juveniles and include soft, sandy bottoms, on or near structures such as rocky ledges, wrecks, artificial reefs, and mussel beds in euryhaline areas (Briggs 1975a; Eklund 1988; MAFMC 1996). Adults collected in the fall NEFSC trawl survey (1963-1997) were most commonly caught at about the same depth and water temperatures as juveniles. However, during migration, scup tend to school by size. (Neville and Talbot 1964; Sisson 1974; Morse 1978).

### Black Sea Bass

Black sea bass habitat includes pelagic waters, demersal waters, and structured habitats (rocky reefs, cobble/rock fields, stony coral, and sponge patches) and polyhaline regions of many estuaries (Drohan et al. 2005). The Mid-Atlantic black sea bass stock extends from Cape Hatteras to the Gulf of Maine. In the Mid-Atlantic Bight, juvenile and adult black sea bass migrate from nearshore continental shelf habitats to outer shelf over-wintering areas as bottom temperatures decline in the fall. The center of biomass of black sea bass in the spring when fish are offshore has moved northward by about 150-200 km between 1972 and 2008 (Bell et al. 2015).

Juveniles are relatively common in estuaries south of Cape Cod. Within estuaries, young fish use shallow shellfish, sponge, amphipod, seagrass beds, and cobble habitats as well as manmade structures such as wharves, pilings, wrecks, reefs, crab and conch pots (Drohan et al. 2005). Young juveniles are rare on unvegetated sandy intertidal flats and beaches (Allen et al. 1978) as well as deeper, muddy bottoms (Richards 1963). Juvenile black sea bass also demonstrate a high degree of habitat fidelity during the summer and fall months in estuaries (Able and Hales 1997).

Adult black sea bass appear to remain near complex structures during day, and move to adjacent soft-bottom habitats to feed at night (Steimle and Figley 1996). Primary summer habitats on the nearshore shelf are <60 m deep, but adults may also occupy complex habitats in the lower reaches of large estuaries (~5 m depth). Temperature seems to be especially important components of black sea bass habitat during winter months. At temperatures near 6°C adults become inactive and rest in holes and crevices (Adams 1993). They are also known to burrow into soft sediments during especially cold winters off NC/SC coast (Parker 1990).

#### **1.4.3 Identification and Distribution of Essential Habitat**

EFH for summer flounder, scup, and black sea bass was designated through Amendment 12 to the Summer Flounder, Scup, and Black Sea Bass FMP (MAFMC 1998). EFH designations for each life stage for all three species are described below and pictured in Figures 28, 29, and 30.

##### Summer Flounder

**Eggs:** 1) North of Cape Hatteras, EFH is the pelagic waters found over the Continental Shelf (from the coast out to the limits of the EEZ), from the Gulf of Maine to Cape Hatteras, North Carolina, in the highest 90% of the all the ranked ten-minute squares for the area where summer flounder eggs are collected in the MARMAP survey. 2) South of Cape Hatteras, EFH is the waters over the Continental Shelf (from the coast out to the limits of the EEZ), from Cape Hatteras, North Carolina to Cape Canaveral, Florida, to depths of 360 ft. In general, summer flounder eggs are found between October and May, being most abundant between Cape Cod and Cape Hatteras, with the heaviest concentrations within 9 miles of shore off New Jersey and New York. Eggs are most commonly collected at depths of 30 to 360 ft.

**Larvae:** 1) North of Cape Hatteras, EFH is the pelagic waters found over the Continental Shelf (from the coast out to the limits of the EEZ), from the Gulf of Maine to Cape Hatteras, North Carolina, in the highest 90% of all the ranked ten-minute squares for the area where summer flounder larvae are collected in the MARMAP survey. 2) South of Cape Hatteras, EFH is the nearshore waters of the Continental Shelf (from the coast out to the limits of the EEZ), from Cape Hatteras, North Carolina to Cape Canaveral Florida, in nearshore waters (out to 50 miles from shore). 3) Inshore, EFH is all the estuaries where summer flounder were identified as being present (rare, common, abundant, or highly abundant) in the ELMR database, in the "mixing" (defined in ELMR as 0.5 to 25.0 ppt) and "seawater" (defined in ELMR as greater than 25 ppt) salinity zones. In general, summer flounder larvae are most abundant nearshore (12-50 miles from shore) at depths between 30 and 230 ft. They are most frequently found in the



## DRAFT AMENDMENT FOR PUBLIC COMMENT

northern part of the Mid-Atlantic Bight from September to February, and in the southern part from November to May.

**Juveniles:** 1) North of Cape Hatteras, EFH is the demersal waters over the Continental Shelf (from the coast out to the limits of the EEZ), from the Gulf of Maine to Cape Hatteras, North Carolina, in the highest 90% of all the ranked ten-minute squares for the area where juvenile summer flounder are collected in the NEFSC trawl survey. 2) South of Cape Hatteras, EFH is the waters over the Continental Shelf (from the coast out to the limits of the EEZ) to depths of 500 ft, from Cape Hatteras, North Carolina to Cape Canaveral, Florida. 3) Inshore, EFH is all of the estuaries where summer flounder were identified as being present (rare, common, abundant, or highly abundant) in the ELMR database for the "mixing" and "seawater" salinity zones. In general, juveniles use several estuarine habitats as nursery areas, including salt marsh creeks, seagrass beds, mudflats, and open bay areas in water temperatures greater than 37 °F and salinities from 10 to 30 ppt range.

**Adults:** 1) North of Cape Hatteras, EFH is the demersal waters over the Continental Shelf (from the coast out to the limits of the EEZ), from the Gulf of Maine to Cape Hatteras, North Carolina, in the highest 90% of all the ranked ten-minute squares for the area where adult summer flounder are collected in the NEFSC trawl survey. 2) South of Cape Hatteras, EFH is the waters over the Continental Shelf (from the coast out to the limits of the EEZ) to depths of 500 ft, from Cape Hatteras, North Carolina to Cape Canaveral, Florida. 3) Inshore, EFH is the estuaries where summer flounder were identified as being common, abundant, or highly abundant in the ELMR database for the "mixing" and "seawater" salinity zones. Generally summer flounder inhabit shallow coastal and estuarine waters during warmer months and move offshore on the outer Continental Shelf at depths of 500 ft in colder months.

### Scup

**Eggs:** EFH is estuaries where scup eggs were identified as common, abundant, or highly abundant in the ELMR database for the "mixing" and "seawater" salinity zones. In general scup eggs are found from May through August in southern New England to coastal Virginia, in waters between 55 and 73 °F and in salinities greater than 15 ppt.

**Larvae:** EFH is estuaries where scup were identified as common, abundant, or highly abundant in the ELMR database for the "mixing" and "seawater" salinity zones. In general scup larvae are most abundant nearshore from May through September, in waters between 55 and 73 °F and in salinities greater than 15 ppt.

**Juveniles:** 1) Offshore, EFH is the demersal waters over the Continental Shelf (from the coast out to the limits of the EEZ), from the Gulf of Maine to Cape Hatteras, North Carolina, in the highest 90% of all the ranked ten-minute squares of the area where juvenile scup are collected in the NEFSC trawl survey. 2) Inshore, EFH is the estuaries where scup are identified as being common, abundant, or highly abundant in the ELMR database for the "mixing" and "seawater" salinity zones. Juvenile scup, in general during the summer and spring are found in estuaries and bays between Virginia and Massachusetts, in association with various sands, mud, mussel

## DRAFT AMENDMENT FOR PUBLIC COMMENT

and eelgrass bed type substrates and in water temperatures greater than 45 °F and salinities greater than 15 ppt.

**Adults:** 1) Offshore, EFH is the demersal waters over the Continental Shelf (from the coast out to the limits of the EEZ), from the Gulf of Maine to Cape Hatteras, North Carolina, in the highest 90% of all the ranked ten-minute squares of the area where adult scup are collected in the NEFSC trawl survey. 2) Inshore, EFH is the estuaries where scup were identified as being common, abundant, or highly abundant in the ELMR database for the "mixing" and "seawater" salinity zones. Generally, wintering adults (November through April) are usually offshore, south of New York to North Carolina, in waters above 45 °F.

### Black Sea Bass

**Eggs:** EFH is the estuaries where black sea bass eggs were identified in the ELMR database as common, abundant, or highly abundant for the "mixing" and "seawater" salinity zones. Generally, black sea bass eggs are found from May through October on the Continental Shelf, from southern New England to North Carolina.

**Larvae:** 1) North of Cape Hatteras, EFH is the pelagic waters found over the Continental Shelf (from the coast out to the limits of the EEZ), from the Gulf of Maine to Cape Hatteras, North Carolina, in the highest 90% of all ranked ten-minute squares of the area where black sea bass larvae are collected in the MARMAP survey. 2) EFH also is estuaries where black sea bass were identified as common, abundant, or highly abundant in the ELMR database for the "mixing" and "seawater" salinity zones. Generally, the habitats for the transforming (to juveniles) larvae are near the coastal areas and into marine parts of estuaries between Virginia and New York. When larvae become demersal, they are generally found on structured inshore habitat such as sponge beds.

**Juveniles:** 1) Offshore, EFH is the demersal waters over the Continental Shelf (from the coast out to the limits of the EEZ), from the Gulf of Maine to Cape Hatteras, North Carolina, in the highest 90% of all the ranked squares of the area where juvenile black sea bass are collected in the NEFSC trawl survey. 2) Inshore, EFH is the estuaries where black sea bass are identified as being common, abundant, or highly abundant in the ELMR database for the "mixing" and "seawater" salinity zones. Juveniles are found in the estuaries in the summer and spring. Generally, juvenile black sea bass are found in waters warmer than 43 °F with salinities greater than 18 pp and coastal areas between Virginia and Massachusetts, but winter offshore from New Jersey and south. Juvenile black sea bass are usually found in association with rough bottom, shellfish and eelgrass beds, man-made structures in sandy-shelly areas; offshore clam beds and shell patches may also be used during the wintering.

**Adults:** 1) Offshore, EFH is the demersal waters over the Continental Shelf (from the coast out to the limits of the EEZ), from the Gulf of Maine to Cape Hatteras, North Carolina, in the highest 90% of all the ranked ten-minute squares of the area where adult black sea bass are collected in the NEFSC trawl survey. 2) Inshore, EFH is the estuaries where adult black sea bass were identified as being common, abundant, or highly abundant in the ELMR database for the

DRAFT AMENDMENT FOR PUBLIC COMMENT

"mixing" and "seawater" salinity zones. Black sea bass are generally found in estuaries from May through October. Wintering adults (November through April) are generally offshore, south of New York to North Carolina. Temperatures above 43 °F seem to be the minimum requirements. Structured habitats (natural and man-made), sand and shell are usually the substrate preference.

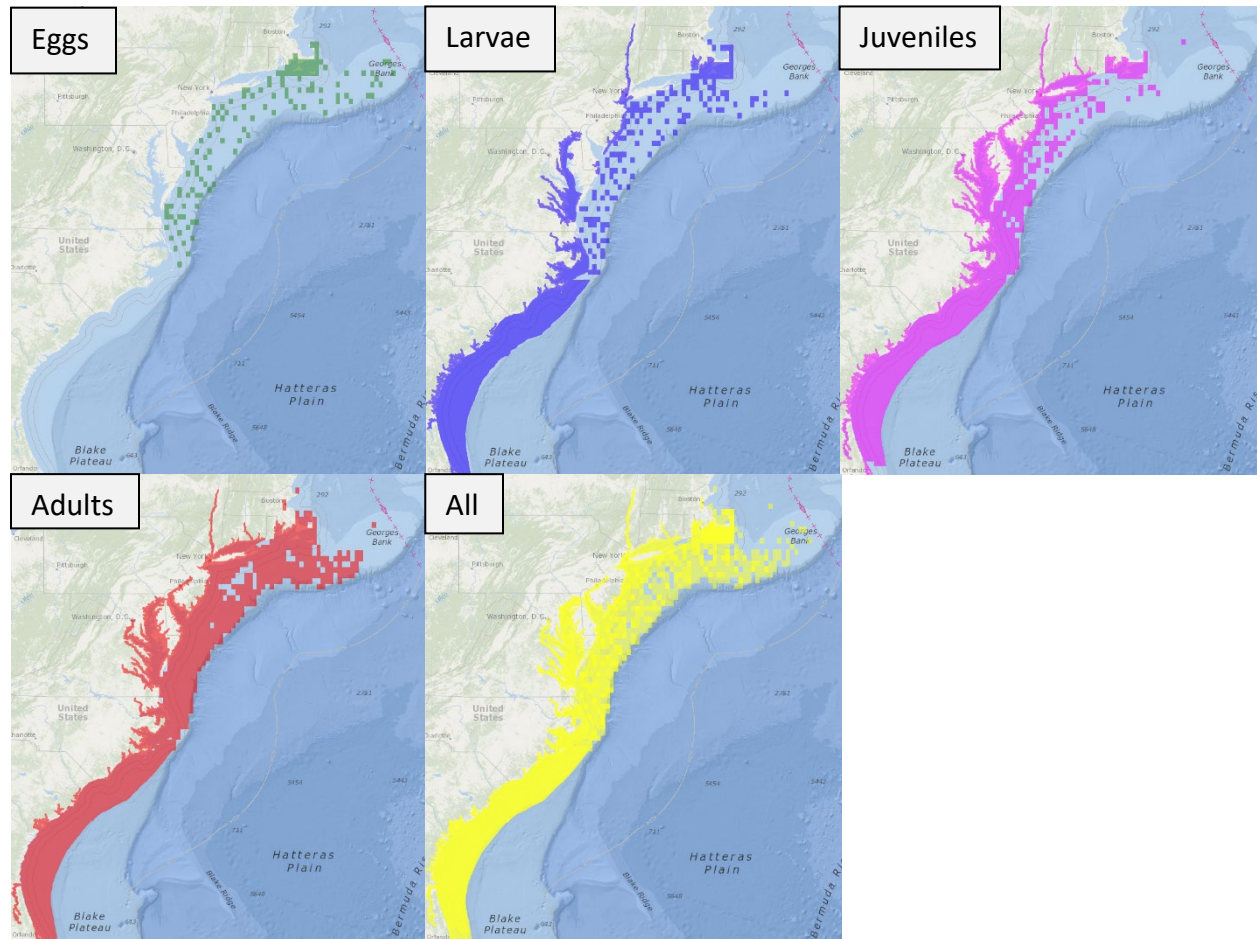


Figure 28. Designated EFH for summer flounder at various life stages. Image source: NOAA Office of Habitat Conservation EFH Mapper.

DRAFT AMENDMENT FOR PUBLIC COMMENT

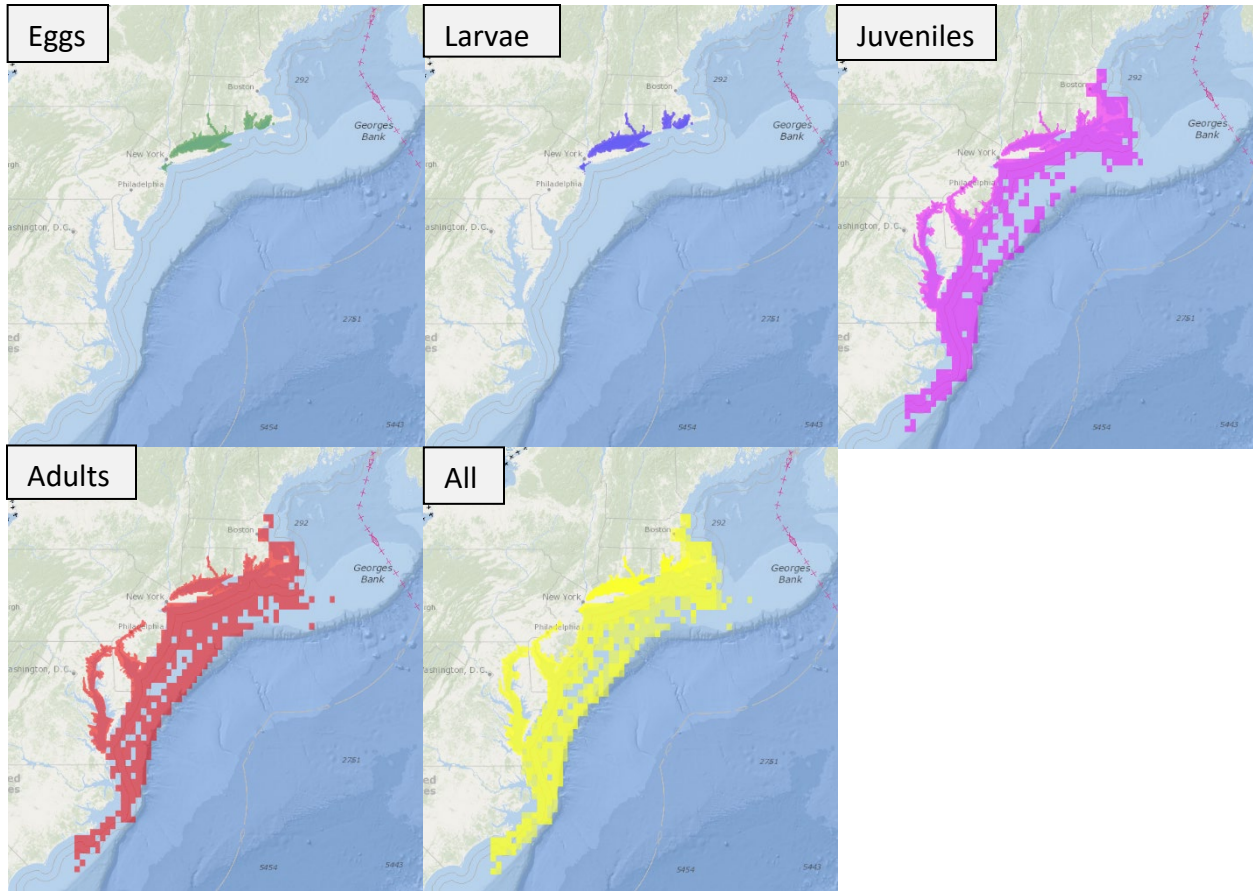
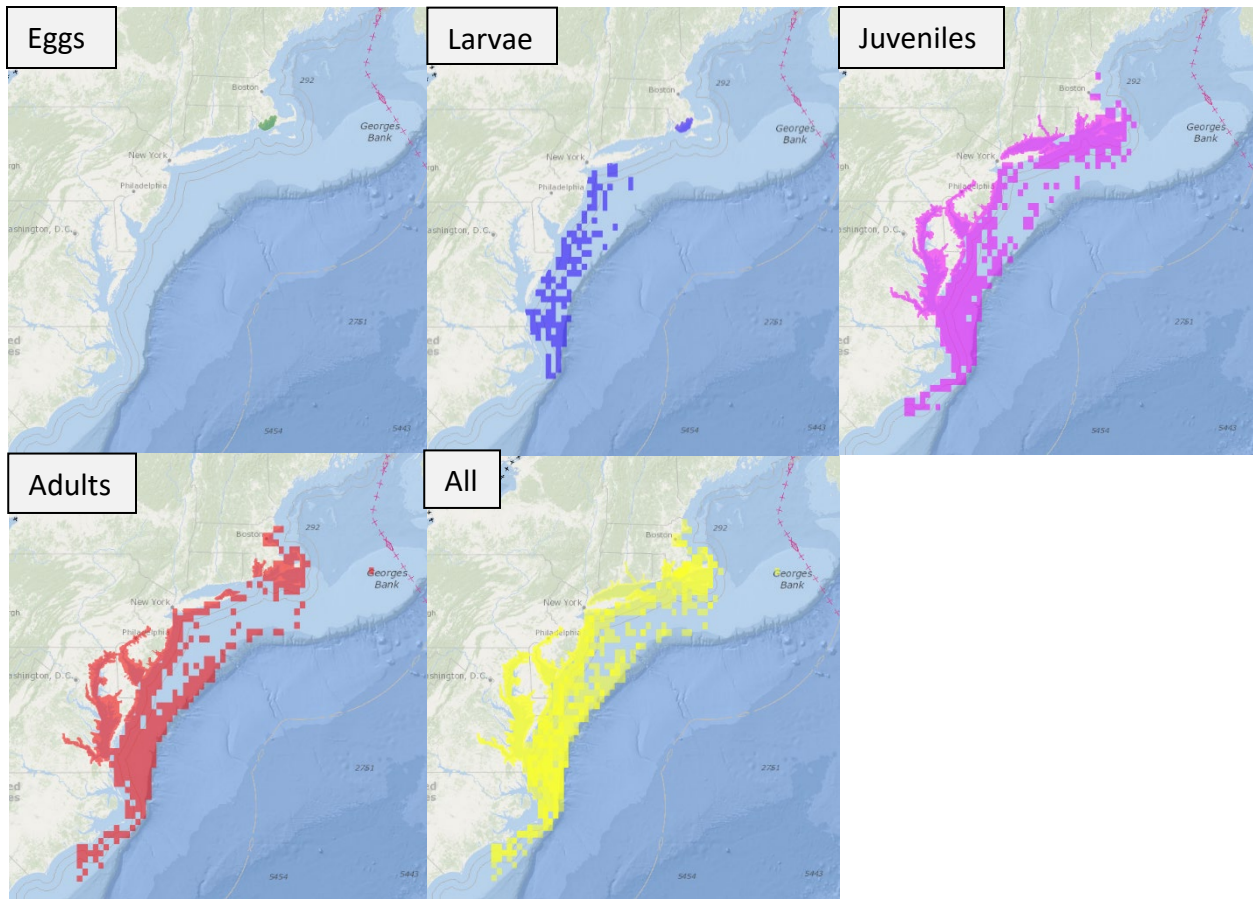


Figure 29. Designated EFH for scup at various life stages. Image source: NOAA Office of Habitat Conservation EFH Mapper.

DRAFT AMENDMENT FOR PUBLIC COMMENT



**Figure 30. Designated EFH for black sea bass at various life stages. Image source: NOAA Office of Habitat Conservation EFH Mapper.**



#### 1.4.4 Anthropogenic Impacts on Summer Flounder, Scup, and Black Sea Bass and Their Habitat

Only those gear types which contact the bottom impact physical habitat. The actions proposed in this document are relevant to both the commercial and recreational summer flounder, scup, and black sea bass fisheries. The recreational fisheries for all three species are almost exclusively hook and line fisheries. Recreational hook and line gears generally have minimal impacts on physical habitat and EFH in this region (Stevenson et al. 2004). Weighted hook and line gear can contact the bottom, but the magnitude and footprint of any impacts resulting from this contact is likely minimal. Thus, the recreational fisheries are expected to have very minor or no impacts on habitat.

The commercial fisheries for all three species are primarily prosecuted with bottom trawl gear. Within the dealer data, from 2014-2019, otter trawls accounted for about 90% of all summer flounder commercial landings, 82% of scup landings and 57% of black sea bass commercial landings. Black sea bass had a higher proportion of landings from pot and trap gear, estimated at 23% from 2015-2019, and 11% from handlines (Table 20).

**Table 20. Percent of reported commercial scup and black sea bass landings taken by gear category from 2015-2019 based on dealer data.**

Dealer Data (2015-2019)	Summer flounder	Scup	Black Sea Bass
<b>BOTTOM TRAWL</b>	90.3%	82.4%	57.0%
<b>OTHER OR UNKNOWN</b>	5.2%	11.1%	8.3%
<b>POT AND TRAP</b>	0.2%	3.3%	23.0%
<b>HANDLINE</b>	2.9%	2.3%	11.0%
<b>GILLNET</b>	1.1%	1.0%	0.8%
<b>SCALLOP DRED</b>	0.3%	0.0%	0.0%

Stevenson et al. (2004) compiled a detailed summary of several studies on the impacts of a variety of gear types on marine habitats. Conclusions relevant for this action are briefly summarized below with a focus on bottom trawl gear since this is the predominant gear type used in commercial harvest of all three species.

Otter trawl doors can create furrows in sand, mud, and gravel/rocky substrates. Studies have found furrow depths that range from 2 to 10 cm. Bottom trawl gear can also re-suspend and disperse surface sediments and can smooth topographic features. It can also result in reduced abundance, and in some cases reduced diversity, of benthic species such as nematodes, polychaetes, and bivalves. It can also have short-term positive ecological impacts such as increased food value and increased chlorophyll production in surface sediments. The duration of these impacts varies by sediment type, depth, and frequency of the impact (e.g., a single trawl tow vs. repeated tows). Some studies documented effects that lasted only a few months. Other studies found effects that lasted up to 18 months. Impacts tend to have shorter durations in dynamic environments with less structured bottom composition compared to less dynamic environments with structured bottom. Shallower water, stronger bottom currents, more wave

action, finer-grained sediments, and higher frequencies of natural disturbance are characteristics that make environments more dynamic (Stevenson et al. 2004).

Compared to otter trawls and dredges, Stevenson et al. (2004) summarized fewer studies on other bottom tending gears such as traps. Morgan and Chuenpagdee (2003) found that the impacts of bottom gill nets, traps, and longlines were generally limited to warm or shallow-water environments with rooted aquatic vegetation or “live bottom” environments (e.g., coral reefs). These impacts were of a lesser degree than those from bottom trawls and dredges. Eno et al. (2001) found that traps can bend, smother, and uproot sea pens in soft sediments; however, sea pen communities were largely able to recover within a few days of the impact.

#### **1.4.5 Description of Programs to Protect, Restore, & Preserve Summer Flounder, Scup, and Black Sea Bass**

The Mid-Atlantic Council developed some fishery management actions with the sole intent of protecting marine habitats. For example, in Amendment 9 to the Mackerel, Squid, and Butterfish FMP, the Council determined that bottom trawls used in Atlantic mackerel, longfin and *Illex* squid, and butterfish fisheries have the potential to adversely affect EFH for some federally-managed fisheries (MAFMC 2008). As a result of Amendment 9, closures to squid trawling were developed for portions of Lydonia and Oceanographer Canyons. Subsequent closures were implemented in these and Veatch and Norfolk Canyons to protect tilefish EFH by prohibiting all bottom trawling activity. In addition, Amendment 16 to the Mackerel, Squid, and Butterfish FMP prohibits the use of all bottom-tending gear in fifteen discrete zones and one broad zone where deep sea corals are known or highly likely to occur (81 Federal Register 90246, December 14, 2016).

Actions implemented in the Summer Flounder, Scup, and Black Sea Bass FMP that affected species with overlapping EFH were considered Amendment 13 (MAFMC 2002). The analysis in Amendment 13 indicated that no management measures were needed to minimize impacts to EFH because the trawl fisheries for summer flounder, scup, and black sea bass in federal waters are conducted primarily in high energy mobile sand and bottom habitat where gear impacts are minimal and/or temporary in nature.

### **1.5 IMPACTS TO THE FISHERY MANAGEMENT PROGRAM**

The following sections provide a brief summary of biological and socioeconomic impacts that may result from allocation changes between the commercial and recreational fisheries for summer flounder, scup, and black sea bass. Impacts to the fisheries are alternative specific, and a more detailed discussion of alternatives and their impacts can be found in section 4.4.

#### **1.5.1 Biological Impacts**

Changes to the recreational and commercial sector allocations affect the size of each sector’s landings limits. Depending on the scale of the change, a decrease in the commercial quota or additional restrictions on the recreational fishery could lead to increased regulatory discards of these species compared to recent levels. However, accountability measures are still in place and designed to prevent harvest and dead discards from exceeding the overfishing threshold. In addition, a preliminary analysis taking into account the different levels of variation of the

estimates of landings and dead discards in each sector indicates that proposed changes in the recreational and commercial sectors may not have notably different impacts on the risk of exceeding the ABC for all three species. None of the alternatives are expected to change patterns in landings, discards, or fishing effort in such a way that they negatively impact stock status for any of the three species.

### **1.5.2 Socioeconomic Impacts**

Changes in the RHL may lead to a liberalization or restriction of recreational measures, which can impact angler access to all three species. Increased access could take the form of more fish to take home (under higher possession limits or lower minimum fish sizes) and more opportunities to target these species (under longer open seasons), while decreased access could mean the ability to retain fewer fish and reduced opportunities to target these species. This can affect angler satisfaction, revenues for for-hire businesses (e.g., by impacting demand for for-hire trips), and revenues for support businesses such as bait and tackle shops.

The proposed allocation alternatives represent either status quo or a reduction to the commercial sector allocation. As such, the commercial sector may experience a loss in revenue due to corresponding decreased quotas and a reduction in potential landings of summer flounder and black sea bass. For scup, this will depend on the degree of the decrease in the quota as the commercial scup quota has not been fully harvested since 2007 due to other factors such as market demand. For all three species, the loss in revenue associated with the reduction in quota is not expected to be linear, as the relationship between price and volume landed in the fishery is not linear and is variable by species. Other factors such as variation in costs can also affect revenue. Some negative impacts associated with quota reductions might be partially offset by the potential for increased prices paid by dealers if decreased quotas result in decreased supply. However, the degree to which this happens depends on the relationship between demand and price.

## **2.0 GOALS AND OBJECTIVES**

### **2.1 HISTORY OF MANAGEMENT**

**The original ASMFC FMP (1982)** included only summer flounder and recommended a 14" minimum size limit (for both recreational and commercial possession). The 1988 joint MAFMC-ASMFC Plan established a 13" minimum size limit, permit requirements, and a plan to begin annually reviewing fishing mortality estimates and the performance of management measures after the third year of FMP implementation. Since then, twenty-one amendments have been developed and approved. Most but not all amendments have been implemented jointly by the Commission and Council.

**Amendment 1 (1990)** added an overfishing definition to the FMP and proposed a minimum net mesh size to protect the 1989 and 1990 year classes. NOAA Fisheries approved the overfishing definition, but disapproved the minimum net mesh provision because the mesh size along with the existing minimum fish size would not allow the overfished resource to rebuild.



**Amendment 2 (1993)** was a comprehensive amendment designed to rebuild a severely depleted summer flounder stock. The amendment contained a number of management measures to regulate the commercial and recreational fisheries for summer flounder including a rebuilding schedule, commercial quotas, RHLs, size limits, gear restrictions including minimum mesh sizes, and permit and reporting requirements. Amendment 2 established a mesh size exemption for the flynet fishery, as well as the small mesh exemption area, an offshore area where fishermen participating in the winter trawl fishery may obtain an authorized exemption from the minimum mesh size regulations. Amendment 2 also established the Summer Flounder Monitoring Committee, which meets annually to review the best available biological and fisheries data and make recommendations regarding the commercial quota and other management measures.

**Amendment 3 (1993)** modified the demarcation line for the small mesh exempted fishery area, and increased the large mesh net possession threshold (established in Amendment 2) to 200 lbs during the winter fishery (November 1-April 30). Amendment 3 also stipulated that otter trawl vessels fishing from 1 May through 31 October could only retain up to 100 lbs of summer flounder before using the large mesh net.

**Amendment 4 (1993)** adjusted Connecticut's commercial landings of summer flounder and revised the state-specific shares of the coastwide commercial summer flounder quota as requested by the Commission. **Amendment 5 (1993)** allowed states to transfer or combine portions of their commercial quota. **Amendment 6 (1994)** allowed multiple nets on board if they were properly stowed and changed the deadline for publishing the overall catch limits and commercial management measures to 15 October and the recreational management measures to 15 February. **Amendment 7 (1995)** revised the fishing mortality rate reduction schedule for summer flounder.

The Scup FMP and the Black Sea Bass FMP were incorporated into the summer flounder regulations as **Amendments 8 and 9 (1996)** to the Council's Summer Flounder FMP, respectively. There are no Amendments 8 or 9 in the Atlantic States Marine Fisheries Commission's (ASMFC or Commission) FMP. The Board opted to manage Scup and Black Sea Bass under separate FMPs. The Council's Amendments 8 and 9 were major amendments that implemented a number of management measures for scup and black sea bass including commercial quotas, commercial gear requirements, minimum size limits, RHLs, and permit and reporting requirements. The FMP included a seven-year plan for reducing fishing effort and restoring the scup stock due to excessive discarding of scup and near collapse of the stock. Management measures implemented in the first year of the plan (1996) included: dealer and vessel permitting and reporting, 9-inch commercial minimum size, 4-inch mesh restriction for vessels retaining over 4,000 pounds of scup, and a 7-inch recreational minimum size along with flexibility in addressing unforeseen conditions in the fishery. The initial black sea bass FMP (1996) aimed to reduce fishing mortality using a coastwide commercial quota allocated into quarterly periods beginning in 1998, and a RHL constrained through the use of minimum size, possession limit, and seasonal closures.

## DRAFT AMENDMENT FOR PUBLIC COMMENT

**Addendum 1 (1996)** established the scup quota management procedure for management and distribution of the annual coastwide commercial quota. Addendum 1 also detailed the state-by-state quota system for the scup summer period (May through October) that was implemented in 1997. Each state receives a share of the summer quota based on historical commercial landings from 1983-1992.

**Amendment 10 (1997)** made several changes to the summer flounder regulations. Specifically, this Amendment modified the commercial minimum mesh regulations, continued the moratorium on entry of additional commercial vessels, removed provisions pertaining to the expiration of the moratorium permit, prohibited the transfer of summer flounder at sea, and established a special permit for party/charter vessels to allow the possession of summer flounder parts smaller than the minimum size.

**Amendment 11 (1999)** was implemented to achieve consistency among Mid-Atlantic and New England FMPs regarding vessel replacement and upgrade provisions, permit history transfer, splitting, and renewal regulations for fishing vessels issued Northeast Limited Access federal fishery permits.

**Amendment 12 (1999)** combined the three species' FMPs from the Commission's perspective and was approved by the Commission and MAFMC in October 1998. Amendment 12 brought the FMP into compliance with the new and revised National Standards and other required provisions of the Sustainable Fisheries Act (SFA). Specifically, the amendment revised the overfishing definitions (National Standard 1) for summer flounder, scup, and black sea bass and addressed the new and revised National Standards (National Standard 8 - consider effects on fishing communities; National Standard 9 - reduce bycatch; and National Standard 10 - promote safety at sea) relative to the existing management measures. The amendment also identified essential habitat for summer flounder, scup and black sea bass. In addition, Amendment 12 added a framework adjustment procedure that allows the Council to add or modify management measures through a streamlined public review process. For scup, the amendment set overfished and overfishing thresholds.

To address the issues of black sea bass fishery closures, large discards, and financial hardships, the Board enacted a series of Emergency Rules in 2001 that established initial possession limits, triggers, and adjusted possession limits. These measures helped reduce the length of fishery closures, but the rapidly changing regulations confused fishermen and added significant administrative burden to the states. To simplify the process for all parties, the Board approved Addendum VI to provide a mechanism for initial possession limits, triggers, and adjusted possession limits to be set during the annual specification setting process without the need for further Emergency Rules.

**Addendum IV (2001)** provides that upon the recommendation of the relevant monitoring committee and joint consideration with the Council, the Board will decide state regulations

rather than forward a recommendation to NOAA Fisheries. Addendum IV also made the states responsible for implementing the Board's decisions on regulations.

**Addendum V (2002)** was developed to avoid the necessity of developing annual Emergency Rules for scup summer period quota management. Addendum V established state shares of the summer period quota based on historical commercial landings from 1983-1992, including additional landings from Massachusetts added to the NOAA Fisheries database in 2000. State shares implemented by this addendum will remain in place until the Board takes direct action to change them.

**Addendum VII (2002)** established a state specific management program for Massachusetts through New York for the 2002 recreational scup fishery based on the average landings (in number of fish) for 1998-2001. Due to the extremely limited data available, the Board developed specific management measures for the states of New Jersey, Delaware, Maryland, Virginia, and North Carolina. The addendum had no application after 2002. The same addendum language was used verbatim to set management measures for the states of Massachusetts through New York for 2003 through Addendum IX.

**Amendment 13 (2002)** was approved by the Commission and MAFMC and implemented a federal, annual coastwide commercial quota for black sea bass that is managed in state waters by the Commission using a state-by-state allocation system. Amendment 13 also removed the necessity for fishermen who have both a Northeast Region (NER, now referred to as the Greater Atlantic Region) Black Sea Bass permit and a Southeast Region (SER) Snapper Grouper (S/G) permit to relinquish their permits for a six-month period prior to fishing south of Cape Hatteras during a northern closure.

**Addendum XIII and the MAFMC's complementary Framework 5 (2004)** modified the FMP so that Total Allowable Landings (TALs) for the summer flounder, scup, and/or black sea bass can be specified for up to three years.

**Amendment 14 (2007)** established a rebuilding schedule for scup and made the Scup Gear Restricted Areas (GRAs) modifiable through the framework adjustment process. **Amendment 16 (2007)** implemented Standardized Bycatch Reporting Methodology (SBRM).

**Addendum XIX (2007)** continued the state-by-state black sea bass commercial management measures, without a sunset clause. This addendum, and the MAFMC's complementary Framework 7, also broadened the descriptions of stock status determination criteria contained within the Summer Flounder, Scup, and Black Sea Bass FMP to allow for greater flexibility in those definitions, while maintaining objective and measurable status determination criteria for identifying when stocks or stock complexes covered by the FMP are overfished. It established acceptable categories of peer-review for stock status determination criteria. When these specific peer-review metrics are met and new or updated information is available, the new or revised stock status determination criteria may be incorporated by the Commission directly into

## DRAFT AMENDMENT FOR PUBLIC COMMENT

the annual management measures for each species, rather than requiring a modification to the FMP.

**Addendum XX (2009)** set policies to reconcile quota overages to address minor inadvertent quota overages in the black sea bass and scup summer period fisheries. It streamlines the quota transfers process and establishes clear policies and administrative protocols to guide the allocation of transfers from states with underages to states with overages. It also allows for quota transfers to reconcile quota overages after the year's end.

**Amendment 15 (2011)** Established Annual Catch Limits and Accountability Measures, as required by the 2007 reauthorization of the Magnuson-Stevens Fishery Conservation and Management Act (MSA).

Beginning in 2011 due to concerns about equitable access to the resource, a series of addenda replaced the use of uniform coastwide measures to manage the black sea bass recreational fishery. **Addendum XXI (2011)** established state shares of the RHL for 2011. **Addenda XXII, XXIII, XXV, and XXVII** implemented an ad hoc regional management approach for 2012-2017, whereby the northern region states of Massachusetts through New Jersey individually crafted state measures aimed at liberalizing or reducing harvest by the same percent to achieve the RHL, while the southern region states of Delaware through North Carolina largely set regulations consistent with the measures set for federal waters.

**Amendment 19 (2013)** modified the AMs for the Council's recreational fisheries. **Amendment 17 (2015)** implemented a revised version of the Standardized Bycatch Reporting Methodology (SBRM). **Amendment 18 (2015)** eliminated the requirement for vessel owners to submit "did not fish" reports for the months or weeks when their vessel was not fishing, and removed some of the restrictions for upgrading vessels listed on Federal fishing permits. **Amendment 20 (2017)** implemented management measures to prevent the development of new, and the expansion of existing, commercial fisheries on certain forage species in the Mid-Atlantic.

**Addendum XXIX (2017)** shortened the length of the commercial scup summer period and extended the length of the winter II period. The addendum was developed to allow for the better utilization of the commercial quota, which was under-harvested from 2011-2016. Specifically, the change in quota period length allows for higher possession limits for a longer period of time each year, thus increasing the likelihood the commercial fishery will fully harvest the quota. The quota allocation for each period remains unchanged. While Addendum XXIX is a Commission specific document, the Council also took the same action through **Framework 10**. The new quota periods are the following and were implemented for the 2018 fishing season: Winter I, January 1-April 30 (120 days); Summer, May 1-September 30 (153 days); Winter II, October 1-December 31 (92 days).

**Addendum XXX (2018)** established a regional allocation of the coastwide RHL to address state concerns regarding equity and accountability in recreational black sea bass management. Based on a combination of exploitable biomass information from the latest stock assessment and

## DRAFT AMENDMENT FOR PUBLIC COMMENT

historical harvest, the RHL was allocated to three regions: 1) Massachusetts through New York, 2) New Jersey as a state-specific region, and 3) Delaware through North Carolina. The 2018 state recreational measures were then revised in May 2018 following an appeal of the Addendum to the ISFMP Policy Board by Massachusetts, Rhode Island, Connecticut and New York.

**Addendum XXXI (2018) and council Framework 14 (2018)** modified the FMP to allow for the option of federal conservation equivalency for the recreational black sea bass fishery beginning in 2020, and implemented transit provisions for Block Island Sound for recreational and commercial fisheries for summer flounder, scup, and black sea bass in the same area as the existing striped bass transit zone. The Council's framework action also modified the Council's FMP to allow a maximum size limit to be used in the recreational fisheries for summer flounder and black sea bass.

**Addendum XXXII (2018)** established a new process for developing recreational management measures for black sea bass and summer flounder whereby measures are set annually through a specifications process, rather than addenda. The Board approves measures in early spring each year, based on Technical Committee analysis of stock status, resource availability, and harvest estimates. To further aid in setting specifications, the Addendum established standards and guiding principles intended to structure the development of recreational measures on a regional basis. Public input on specifications is gathered by states through their individual public comment processes.

**Amendment 21 (2020)** revised the management program's goals and objectives specific to summer flounder and implemented new summer flounder state-specific commercial allocations. The new state commercial allocations are based upon a 9.55 million pound trigger point. When the annual coastwide commercial quota is at or below 9.55 million pounds, the formula for allocating the quota to the states remains status quo, i.e., the same state-specific percentages that have been in effect since 1993. When the annual coastwide quota exceeds 9.55 million pounds, additional quota above 9.55 million pounds is distributed as follows: 0.333% to the states of Maine, New Hampshire and Delaware and 12.375% to the remaining states. As a result, state allocations will vary over time based on overall stock status and the resulting coastwide commercial quotas.

In October 2019, the Board initiated **Draft Addendum XXXIII** to consider changes to black sea bass commercial state allocations. This action will consider the current distribution and abundance of black sea bass as one of several adjustment factors to achieve more balanced access to the resource. In December 2019, the Council initiated a complementary amendment which will consider including the state specific commercial allocations in the Council FMP. A draft document was approved for public comment in August 2020.

## 2.2 JOINT MANAGEMENT

The Council and Commission work cooperatively to develop fishery regulations for summer flounder, scup, and black sea bass off the east coast of the United States. The Council and Commission work in conjunction with NOAA Fisheries, which serves as the federal implementation and enforcement entity. This cooperative management endeavor was developed because a significant portion of the catch is taken from both state (0-3 miles offshore) and federal waters (3-200 miles offshore, also known as the EEZ).

The Commission has primary authority for development of FMPs for state waters under the authority of the Atlantic Coastal Fisheries Cooperative Management Act (ACFCMA) of 1993. Recognizing the interjurisdictional nature of fishery resources and the necessity of the states and federal government coordination on regulations, under this act, all Atlantic coast states that are included in a Commission FMP must implement required conservation provisions of the plan or the Secretary of Commerce may impose a moratorium for fishing in the noncompliant state's waters.

The Council, under the MSA, has primary authority for developing federal FMPs for Council managed species. The Commission and the Council meet jointly at least twice a year to approve management measures for the fishery for the upcoming year or years. State fishery departments implement FMP measures under the ACFCMA, while NOAA Fisheries issues rules to implement approved FMPs prepared by the Councils.

State regulations apply to vessels fishing in state waters; however, vessels with federal permits must abide by the federal regulations regardless of where they are fishing. If state and federal measures differ, the vessel must abide by whichever measure is more restrictive. Approved regulations are enforced through cooperative actions of the U.S. Coast Guard, NOAA Fisheries Law Enforcement, and state authorities.

The Secretary of Commerce has the ultimate responsibility for measures. The Council's proposed FMPs and amendments are submitted to the Secretary of Commerce for approval, which in most cases is delegated to NOAA Fisheries. NOAA Fisheries typically prepares specifications and implementing federal regulations for the fisheries based on the recommendations of the Council and Commission, if such recommendations are deemed to be consistent with the MSA and other applicable law. NOAA Fisheries publishes proposed rules in the *Federal Register* for public comment. As mentioned above, the Secretary of Commerce also has ultimate responsibility for determining whether individual state measures are consistent with the Commission's FMP. If the Commission finds a state out of compliance and is unable to rectify this issue, the Commission may notify the Secretary. Within 30 days of receiving the Commission's notice, the Secretary must decide whether the state is out of compliance, and if so, whether the noncompliance compromises the conservation of the resource. If it does, the Secretary can impose a moratorium on all fishing (commercial and recreational) for the species in question, until the Commission and the Secretary determine that the noncompliance has ceased.

## **2.3 MANAGEMENT UNIT**

Summer flounder, scup, and black sea bass fisheries are managed cooperatively by the Commission in state waters (0-3 miles), and by the Council and NOAA Fisheries in Federal waters (3-200 miles). The management unit for summer flounder in US waters is the western Atlantic Ocean from the southern border of North Carolina northward to the US-Canadian border. The management unit for scup and black sea bass in US waters is the western Atlantic Ocean from Cape Hatteras, North Carolina north to the Canadian border.

## **2.4 PURPOSE AND NEED FOR ACTION**

The purposes of this Amendment are to:

1. Consider modifications to the current allocations between the commercial and recreational sectors for summer flounder, scup, and black sea bass. The commercial and recreational allocations for all three species are currently based on historical proportions of landings (for summer flounder and black sea bass) or catch (for scup) from each sector. The current allocations were set in the mid-1990s and have not been revised since that time.
2. Consider the option to transfer a portion of the allowable landings each year between the commercial and recreational sectors, in either direction, based on the needs of each sector. The current FMP does not allow for such transfers.
3. Consider whether future additional modifications to the commercial/recreational allocation and/or transfer provisions can be considered through a future FMP addendum or framework action, as opposed to an amendment.

The commercial and recreational allocations for all three species are currently based on historical proportions of landings (for summer flounder and black sea bass) or catch (for scup) from each sector. Recent changes in how recreational catch is estimated has resulted in a discrepancy between the current level of estimated recreational harvest and the recreational allocation for summer flounder, scup, and black sea bass. Some changes have also been made to commercial catch data since the allocations were established.

The commercial and recreational data revisions not only impact catch accounting, but also significantly affected our understanding of the population levels for all three fish stocks. This has management implications due to the fixed commercial/recreational allocation percentages defined in the FMP for all three species. These allocation percentages do not reflect the current understanding of the recent and historic proportions of catch and landings from the two sectors. These allocation percentages are defined in the Council and Commission FMPs; therefore, they can only be modified through an FMP amendment. This Amendment will consider whether the allocations are still appropriate and meeting the objectives of the FMP.

## 2.5 GOALS AND OBJECTIVES

### 2.5.1 Summer Flounder Goals and Objectives

The summer flounder FMP objectives were revised via Amendment 21 to the FMP (approved March 2019). The revised goals and objectives for summer flounder are as follows:

**Goal 1:** Ensure the biological sustainability of the summer flounder resource in order to maintain a sustainable summer flounder fishery.

**Objective 1.1:** Prevent overfishing, and achieve and maintain sustainable spawning stock biomass levels that promote optimum yield in the fishery.

**Goal 2:** Support and enhance the development and implementation of effective management measures.

**Objective 2.1:** Maintain and enhance effective partnership and coordination among the Council, Commission, Federal partners, and member states.

**Objective 2.2:** Promote understanding, compliance, and the effective enforcement of regulations.

**Objective 2.3:** Promote monitoring, data collection, and the development of ecosystem-based science that support and enhance effective management of the summer flounder resource.

**Goal 3:** Optimize economic and social benefits from the utilization of the summer flounder resource, balancing the needs and priorities of different user groups to achieve the greatest overall benefit to the nation.

**Objective 3.1:** Provide reasonable access to the fishery throughout the management unit. Fishery allocations and other management measures should balance responsiveness to changing social, economic, and ecological conditions with historic and current importance to various user groups and communities.

### 2.5.2 Scup and Black Sea Bass Goals and Objectives

The FMP objectives for scup and black sea bass were adopted via the amendments that added these species to this joint FMP (Amendment 8 for scup and Amendment 9 for black sea bass). The current FMP objectives for scup and black sea bass are:

**Goal 1:** Reduce fishing mortality in the scup and black sea bass fisheries to assure that overfishing does not occur.

**Goal 2:** Reduce fishing mortality on immature scup and black sea bass to increase spawning stock biomass.

**Goal 3:** Improve the yield from these fisheries.

**Goal 4:** Promote compatible management regulations between state and federal jurisdictions.

**Goal 5:** Promote uniform and effective enforcement of regulations.

**Goal 6:** Minimize regulations to achieve the management objectives stated above.



## **3.0 MONITORING PROGRAM SPECIFICATION**

In order to achieve the goals and objectives of this Amendment, the collection and maintenance of quality data is necessary.

### **3.1 SUMMARY OF MONITORING PROGRAMS**

The FMPs for summer flounder, scup, and black sea bass include no requirements regarding fishery-dependent monitoring. All state fishery management agencies were encouraged to pursue full implementation of the standards of the Atlantic Coastal Cooperative Statistics Program (ACCSP).

#### **3.1.1 Commercial Catch and Landings Program**

The reporting requirements for the summer flounder, scup, and slack sea bass commercial fisheries are specified by two general permit types: 1) state issued commercial permits and 2) federal moratorium permit. State commercial permits are issued to individuals, with qualification and reporting requirements varying by state. Weekly landings information including species landed by gear and state are submitted by the Atlantic coastal states through the Standard Atlantic Fisheries Information System (SAFIS). Landings information assembled in the SAFIS database include both state and federal landings data. ACCSP's standard for commercial catch and effort statistics requires mandatory, trip-level reporting of all commercial harvested marine species, with fishermen and/or dealers required to report standardized data elements for each trip by the 10<sup>th</sup> of each month. For federal moratorium permit holders, commercial landings information for all three species is collected from VTRs monthly and are submitted 15 days after the end of the reporting month. Discards are estimated from the NEFSC observer program, and, if needed, from the VTR data. The NEFSC weighout program provides commercial age and length information.

#### **3.1.2 Recreational Fishery Catch Reporting Process**

MRIP provides estimated summer flounder, scup, and black sea bass catches from 1981-2019. Recreational catch of these species was previously collected through the MRFSS, which was a recreational data collection program used from 1981-2003. The MRFSS program was replaced by MRIP in 2004 and was designed to provide more accurate and timely reporting as well as greater spatial coverage. The MRFSS and the MRIP were simultaneously conducted in 2004-2006 and this information was used to calibrate past MRFSS recreational harvest estimates against MRIP recreational harvest estimates.

In 2018, MRIP implemented the Fishing Effort Survey (FES) which used an improved methodology to address several concerns with the prior Coastal Household Telephone Survey. These concerns included under-coverage of the angling public, declining number of households with landline telephones, reduced response rates, and memory recall issues. Past estimates have been recalibrated to the FES. This calibration resulted in a much higher recreational catch estimates compared to previous estimates.

Recreational catches of summer flounder, scup, and black sea bass were downloaded from <http://www.st.NOAA Fisheries.noaa.gov/st1/recreational/queries/index.html> using the query option.

An online description of MRIP survey methods can be found here: <http://www.st.NOAA Fisheries.noaa.gov/recreational-fisheries/index#meth>

## **3.2 SOCIAL AND ECONOMIC COLLECTION PROGRAMS**

Data on a number of variables relevant to social and economic dimensions of summer flounder, scup, and black sea bass fisheries are collected through existing ACCSP data collection programs and MRIP; however, no explicit mandates to collect socioeconomic data for these species currently exist. In addition to landed quantities, commercial harvesters and dealers may report ex-vessel prices or value, fishing and landing locations, landing disposition, and a variety of measures capturing fishing effort. MRIP regularly collects information on recreational fishing effort and landings, and occasionally gathers socioeconomic data on angler motivations and expenditures.

## **3.3 BIOLOGICAL DATA COLLECTION PROGRAMS**

### **3.3.1 Fishery-Dependent Data Collection**

Several states along with NOAA Fisheries collect biological information from commercial and recreational fisheries for summer flounder, scup, and black sea bass. The Commonwealth of Massachusetts collects trip-level data on commercial landings from both harvesters and primary buyers, and monitors their commercial quota weekly through their Fisheries Statistics Program. New York conducts a survey of recreational anglers on for-hire boats throughout the marine district that target all three species to collect length data of kept and discarded fish. Maryland compiles data on population, age, sex, and size from any fish caught in pound nets, primarily summer flounder. A statewide voluntary angler survey is conducted that records location, time spent fishing, number of fish caught, number kept, and lengths of the first 20 fish caught. The Virginia Game Fish Tagging Program has targeted and tagged fish since 1997. North Carolina collects information on catch-per-unit-of-effort for the winter trawl fishery, estuarine gill net fishery, pound net fishery, the ocean gill net fishery, commercial gig, and the long-haul seine fishery. North Carolina conducts dockside sampling of the winter trawl fishery to obtain lengths and aggregate weight data for landed species.

### **3.3.2 Observer Program**

As a condition of state and/or federal permitting, many vessels are required to carry at-sea observers when requested. A minimum set of standard data elements are to be collected through the ACCSP at-sea observer program (refer to the ACCSP Program Design document for details). Specific fisheries priorities will be determined by the Discard/Release Prioritization Committee of ACCSP.

### **3.4.3 Fishery-Independent Data Collection**

Several states, along with NOAA Fisheries, conduct seasonal sampling to collect biological information of summer flounder, scup, and black sea bass populations both inshore and in the EEZ. The Commonwealth of Massachusetts conducts spring and fall otter trawl surveys to collect age, length, and maturity data. These data are used to generate young of year and abundance indices for summer flounder, scup, and black sea bass. Rhode Island DEM Marine Fisheries operates a spring and fall seasonal survey to create biomass indices and a monthly trawl survey to produce mean number and weight per tow. Additionally, a beach seine survey is conducted seasonally to monitor juvenile scup abundance. The Long Island Sound Trawl survey is conducted each spring and fall by Connecticut to generate indices of abundance. New York maintains both a small mesh otter trawl survey in the Peconic Bay to monitor young of year, scup yearlings, and scup adult abundance indices and a nearshore trawl survey each winter, spring, summer, and fall to monitor abundance indices. Also conducted is the Nearshore Atlantic trawl survey focuses on collecting biological information and creating indices of abundance for adult and subadult summer flounder and black sea bass. A subset of fish collected by New York on these surveys are used to collect age, length, sex, and maturity. New Jersey conducts an ocean trawl survey five times a year from which age, length and sex data for all three species are collected and catch-per-unit-of-effort and distribution information are generated for juveniles and adults. Two trawl surveys conducted annually in Delaware's estuarine waters to assess relative abundance of both adult and juvenile finfish. Maryland conducts the Coastal Bays Finfish Investigation Trawl and Beach Seine surveys, with a total of 140 trawls and 38 beach seine hauls conducted annually to estimate juvenile abundances. Indices of abundance are calculated from the Virginia Institute of Marine Science (VIMS) Juvenile Trawl Survey and the Chesapeake Bay Multispecies Monitoring and Assessment Program (ChesMMAP). NEAMAP, or the Northeast Area Monitoring and Assessment Program, Trawl Survey generates coastwide age-specific and aggregated age class indices of abundance in the fall and spring.

## **4.0 MANAGEMENT PROGRAM**

Several aspects relating to the commercial and recreational allocation alternatives are subject to Board and Council review in the amendment. Six issues are specified below to allow for public comment and Board and Council decisions on these issues

### **4.1 COMMERCIAL AND RECREATIONAL ALLOCATION ALTERNATIVES**

This section describes the alternatives under consideration for the commercial/recreational allocation percentages for summer flounder (Section 4.1.1), scup (Section 4.1.2), and black sea bass (Section 4.1.3), along with their expected impacts (Section 4.4). The basis for each alternative is described in more detail in Appendix I. The range of allocation alternatives for each species includes options that would maintain the current allocations as well as options to revise them based on updated data using the same or modified base years. Section 4.1.4 describes options to phase in any allocation changes over multiple years, as well as the expected impacts of these phase-in provisions.

Alternatives for both catch-based and landings-based allocations are under consideration for all three species. As described in detail of Section 1.3.5, the same types of catch and landings limits are required under both catch and landings-based allocations (i.e., commercial and recreational annual catch limits, or ACLs, and annual catch targets, commercial quota, and RHL). Dead discards (discarded fish that are assumed to die)<sup>6</sup> must be accounted for in the catch limits under both allocation approaches. Under both approaches, dead discards are subtracted from the catch limits to arrive at the sector-specific landings limit. **The main difference between these approaches is the step in the calculations where the commercial/recreational allocation percentage is applied.** This has implications for how those dead discards are factored into the calculations.

Catch-based allocations (currently in place for scup) apply the commercial/recreational allocation at the acceptable biological catch (ABC) level, meaning the entire amount of allowable catch (i.e. the ABC, which includes landings and dead discards) would be split based on the commercial/recreational allocation percentage defined through the alternatives listed below. Under a landings-based allocation (currently in place for summer flounder and black sea bass), the ABC is first split into the amount expected to come from landings and the amount expected to come from dead discards. The expected landings amount is then split according to the commercial/recreational allocation percentage defined through the alternatives listed below.

It is important to note that **because expected dead discards are handled differently under catch and landings-based approaches, the allocation percentages under these two approaches are not directly comparable.** To allow for comparison across all alternatives, example resulting commercial quotas and RHLs for each species are provided in Section 4.2 (see Appendix II for details on how these exemplified quotas and RHLs were calculated). Actual resulting commercial quotas and RHLs will vary based on annual considerations.

Table 21 provides a summary comparison of the key differences and similarities between catch- and landings-based allocations. The implications of catch vs. landings-based allocations are further discussed in Section 1.3.5 and in Section 4.2.

---

<sup>6</sup> The current discard mortality rates assumed in the stock assessments and catch and landings limits calculations are: 10% for recreational summer flounder discards and 80% for commercial summer flounder discards; 15% for scup recreational discards and 100% for commercial scup discards; 15% for recreational black sea bass discards, 15% for commercial non-trawl black sea bass discards, and 100% for commercial trawl black sea bass discards. These discard mortality rates are used in all aspects of the management program which utilize estimates of dead discards.

**Table 21 Summary of the differences and similarities between catch- and landings-based allocations.**

Catch-based allocations	Landings-based allocations
<ul style="list-style-type: none"> <li>• Currently in place for scup.</li> <li>• <b>Allocation at ABC level as first step:</b> total catch (<b>landings + dead discards</b>) split into recreational and commercial ACLs based on allocation percentage defined in FMP.</li> <li>• The entire ABC is always split among the sectors based on the allocation defined in the FMP, regardless of recent trends in landings and discards by sector. Because of this, changes in landings and dead discards in one sector do not influence the other sector’s ACL.</li> <li>• Expected dead discards are calculated for each sector to subtract from the sector ACLs to determine the sector landings limits</li> </ul>	<ul style="list-style-type: none"> <li>• Currently in place for summer flounder and black sea bass.</li> <li>• ABC is first split into the amount expected to come from landings (Total Allowable Landings, or TAL) and the amount expected to come from dead discards. The methodology for this split is not pre-defined and is usually based on recent trends in landings and dead discards, as well as stock assessment projections where possible.</li> <li>• <b>Allocation at TAL level:</b> TAL is allocated among the commercial and recreational sectors based on the allocation percentage defined in the FMP.</li> <li>• Total expected dead discards are split by sector based on different methods, usually recent trends in discards by sector. The sector specific expected dead discards are subtracted from the sector ACLs to derive the sector landings limits.</li> <li>• Changes in landings and dead discards in one sector over time can impact the catch and landings limits in both sectors by impacting the division of the ABC into expected landings and expected dead discards.</li> </ul>
<p><b>Under Both Approaches:</b></p> <ul style="list-style-type: none"> <li>• Commercial and recreational ACLs, annual catch targets, and landings limits (i.e., commercial quota and RHL) are required.</li> <li>• Expected dead discards must be projected and accounted for by sector.</li> <li>• Only <b>dead</b> discards (discarded fish that are assumed to die) are accounted for in setting and evaluating catch limits. Neither allocation approach includes consideration of released fish that are assumed to survive.</li> <li>• Accountability measures are still required for each sector and tied to sector-specific ACLs. Each sector is held separately accountable for any ACL overages.</li> </ul> <p><b>The main difference between approaches is the step in the calculations at which the commercial/recreational allocation percentages are applied, which has implications for how expected dead discards are projected and divided by sector.</b></p>	

**4.1.1 Summer Flounder Allocation Alternatives**

Table 22 lists the alternatives under consideration for the commercial/recreational summer flounder allocation percentages. The current allocations for summer flounder are landings-based and are represented by the no action/status quo alternative (alternative 1a-4). As described above, both catch- and landings-based alternatives are considered. The percentages under these alternatives are not directly comparable due to differences in how dead discards are addressed under catch-based allocations and landings-based allocations. Appendix II provides examples of potential commercial quotas and RHLs under each alternative to allow for more direct comparisons between the catch and landings-based alternatives. Section 1.3.5 provides more details on the differences between catch- and landings-based allocations and the potential implications of each approach. The rationale behind each allocation alternative is described in more detail in Appendix I.

The alternatives in this section are mutually exclusive, meaning the Council and Board can only choose one of the alternatives from 1a-1 through 1a-7.

**Table 22. Summer flounder commercial/recreational allocation alternatives. The current allocations are highlighted in green.**

Summer Flounder Catch-Based Allocation Percentages	
Alternative	Basis (see Appendix I for details)
1a-1: 44% commercial, 56% recreational	2004-2018 base years
1a-2: 43% commercial, 57% recreational	Supported by multiple approaches: 2009-2018 base years, approximate status quo harvest per sector compared to 2017/2018, and average of other approaches approved by Council/Board in June 2020
1a-3: 40% commercial, 60% recreational	2014-2018 base years
Summer Flounder Landings-Based Allocation Percentages	
Alternative	Basis (see Appendix I for details)
1a-4: 60% commercial, 40% recreational	No action/status quo (1980-1989)
1a-5: 55% commercial, 45% recreational	Same base years, new data (1981-1989; 1980 data unavailable)
1a-6: 45% commercial, 55% recreational	Multiple approaches: 2004-2018 and 2009-2018 base years
1a-7: 41% commercial, 59% recreational	2014-2018 base years

**4.1.2 Scup Allocation Alternatives**

Table 23 lists the alternatives under consideration for the commercial and recreational scup allocation percentages. The current allocations for scup are catch-based and are represented by the no action/status quo alternative (alternative 1b-1). As described above, both catch- and

landings-based alternatives are considered. The percentages under these alternatives are not directly comparable due to differences in how dead discards are addressed under catch- and landings-based allocations. Appendix II provides examples of potential commercial quotas and RHLs under each alternative to allow for more direct comparisons between the catch and landings-based alternatives. Section 1.3.5 provides more details on the differences between catch and landings-based allocations and the potential implications of each approach. The rationale behind each allocation alternative is described in more detail in Appendix I.

The alternatives in this section are mutually exclusive, meaning the Council and Board can only choose one of the alternatives from 1b-1 through 1b-7.

**Table 23 Scup commercial/recreational allocation alternatives. The current allocations are highlighted in green.**

<b>Scup Catch-Based Allocation Percentages</b>	
<b>Alternative</b>	<b>Basis (see Appendix I for details)</b>
<b>1b-1: 78% commercial, 22% recreational</b>	No action/status quo
<b>1b-2: 65% commercial, 35% recreational</b>	Same base years, new data (1988-1992)
<b>1b-3: 61% commercial, 39% recreational</b>	Multiple approaches: 2009-2018 base years and average of other approaches approved by Council/Board in June 2020
<b>1b-4: 59% commercial, 41% recreational</b>	Approximate status quo harvest per sector compared to 2018/2019
<b>Scup Landings-Based Allocation Percentages</b>	
<b>Alternative</b>	<b>Basis (see Appendix I for details)</b>
<b>1b-5: 57% commercial, 43% recreational</b>	Multiple approaches: Same base years, new data; 2014-2018 base years; 2009-2018 base years
<b>1b-6: 56% commercial, 44% rec</b>	2004-2018 base years
<b>1b-7: 50% commercial, 50% recreational</b>	Approximate status quo harvest per sector compared to 2018/2019

#### **4.1.3 Black Sea Bass Allocation Alternatives**

Table 24 lists the alternatives under consideration for the commercial/recreational black sea bass allocation percentages. The current allocations for black sea bass are landings-based and are represented by the no action/status quo alternative (alternative 1c-4). As described above, both catch- and landings-based alternatives are considered. The percentages under these alternatives are not directly comparable due to differences in how dead discards are addressed under catch-based allocations and landings-based allocations. Appendix II provides examples of potential commercial quotas and RHLs under each alternative to allow for more direct comparisons between the catch and landings-based alternatives. Section 1.3.5 provides more details on the differences between catch- and landings-based allocations and the potential

implications of each approach. The rationale behind each allocation alternative is described in more detail in Appendix II.

The alternatives in this section are mutually exclusive, meaning the Council and Board can only choose one of the alternatives from 1c-1 through 1c-7.

**Table 24 Black sea bass commercial/recreational allocation alternatives. The current allocations are highlighted in green.**

<b>Black Sea Bass Catch-Based Percentages</b>	
<b>Alternative</b>	<b>Basis (see Appendix I for details)</b>
<b>1c-1: 32% commercial, 68% recreational</b>	Approximate status quo harvest per sector compared to 2018/2019
<b>1c-2: 28% commercial, 72% recreational</b>	2004-2018 base years
<b>1c-3: 24% commercial, 76% recreational</b>	2009-2018 base years
<b>Black Sea Bass Landings-Based Percentages</b>	
<b>Alternative</b>	<b>Basis (see Appendix I for details)</b>
<b>1c-4: 49% commercial, 51% recreational</b>	No action/status quo
<b>1c-5: 45% commercial, 55% recreational</b>	Same base years, new data (1983-1992)
<b>1c-6: 29% commercial, 71% recreational</b>	Multiple approaches: Approximate status quo harvest per sector compared to 2018/2019 and average of other approaches approved by Council/Board in June 2020
<b>1c-7: 22% commercial, 78% recreational</b>	2009-2018 and 2014-2018 base years

#### **4.1.4 Allocation Change Phase-In Alternatives**

The alternatives listed in Table 25 consider if any changes to the allocation percentages considered through alternative sets 1a, 1b, and 1c should occur in a single year (alternative 1d-1, no phase in) or if the change should be spread over 2, 3, or 5 years (alternatives 1d-2 through 1d-4). The Council and Board agreed that 5 years is a reasonable maximum phase-in time frame as longer transition periods may not adequately address the issue an allocation change is attempting to address. The choice of whether to use a phase-in approach, and the length of the phase-in, may depend on the magnitude of allocation change proposed. A phase-in period may not be desired if the overall allocation change is relatively small. Larger allocation changes may be less disruptive to fishing communities if they are phased in over several years.

These phase-in alternatives could apply to any of the three species. The Council and Board may choose to apply different phase-in alternatives (including no phase-in) to each species if desired.



**Table 25 Allocation change phase-in alternatives.**

<b>Phase-In Alternatives</b>
<b>1d-1:</b> No phase-in
<b>1d-2:</b> Allocation change evenly spread over 2 years
<b>1d-3:</b> Allocation change evenly spread over 3 years
<b>1d-4:</b> Allocation change evenly spread over 5 years

## **4.2 QUOTA TRANSFERS**

The following alternatives describe options for allowing annual transfer of quota between the commercial and recreational sectors as part of the specifications setting process (i.e., the annual process of setting or reviewing catch and landings limits for the upcoming fishing year). This process is similar to that currently used for bluefish, although the options below would allow transfers in either direction between sectors. Section 4.2.1 discusses quota transfer process alternatives while Section 4.2.2 addresses options for a cap on the total amount of a transfer.

### **4.2.1 Quota Transfer Process Alternatives**

Table 26 lists the alternatives under consideration for quota transfer provisions.

**Table 26 Alternatives for annual transfer of quota between the commercial and recreational sectors.**

<b>Annual Quota Transfer Alternatives</b>
<b>2a:</b> No action/status quo (do not modify the FMP to allow transfers of annual quota between the commercial and recreational sectors.)
<b>2b:</b> Allow for optional bi-directional transfers through the annual specifications process with pre-defined guidelines and process. The transfer would consist of a portion of the total ABC in the form of a landings limit (i.e., commercial quota and RHL) transfer. Transfers would not occur if the stock is overfished or overfishing is occurring.

Under alternative 2a, transfers would not be allowed between the commercial and recreational sectors, consistent with past practice and the current FMP requirements for these species.

Under alternative 2b, each year during the setting or review of annual catch limits, the Board and Council could recommend that a portion of the total ABC be transferred between the recreational and commercial sectors as a landings limit transfer, affecting the final commercial quota and RHL. They could recommend a transfer from the commercial fishery to the recreational fishery or from the recreational fishery to the commercial fishery. If a transfer cap is adopted via one of the sub-alternatives under alternative 2c, the transfer amount could not exceed this cap.

Table 27 describes the process of how transfers would work within the Council and Board's current specifications process under alternative 2b.

**Table 27 Proposed quota transfer process during a typical specifications cycle under alternative 2b.**

<p><b>July: Assess the need for a transfer</b></p>	<p>Staff and the Monitoring Committee (MC) would assess the potential need for a transfer and develop recommendations to the Council and Board as part of the specifications process. The MC would consider the expected commercial quota and RHL (pending Council and Board review/approval) in the coming year, and each sector’s performance relative to landings limits in recent years. <b>The MC will have very limited data for the current year and would not be able to develop precise current year projections of landings</b> for each sector. The MC could also consider factors including but not limited to:</p> <ul style="list-style-type: none"> <li>• Projected changes in stock size, availability, or year class strength;</li> <li>• Recent or expected changes in management measures;</li> <li>• Recent or expected changes in fishing effort;</li> </ul> <p>The MC would consider how these factors might have different impacts on the commercial and recreational sectors. The effects of these considerations can be difficult to quantify and there is currently <b>no methodology that would allow the MC to quantitatively determine the need for a transfer with a high degree of precision. The MC would use their best judgement to recommend whether a transfer would further the Council and Board’s policy objectives.</b></p>
<p><b>August: Council and Board consider whether to recommend a transfer</b></p>	<p>The Council and Board would consider MC recommendations on transfers while setting or reviewing annual catch and landings limits. The Council and Board would need to jointly agree on a transfer direction, amount of transfer, and if setting multi-year specifications, whether the transfer would apply for one year or multiple years.</p>
<p><b>October: Council staff submits specifications package to NOAA Fisheries</b></p>	<p>Council staff would prepare and submit supporting documents to modify catch limits or implement or revise transfers. During a multi-year specifications review year, if a transfer is newly adopted or revised, a regulatory package may need to be developed even if catch limits do not change.</p>
<p><b>Mid-December: Recreational measures adopted*</b></p>	<p>The Council and Board would adopt federal waters recreational measures and a general strategy for coastwide recreational management including any reductions or liberalizations needed in state waters. <b>These recommendations would be based on the expected post-transfer RHL which likely would not yet be implemented via final rule.</b></p>
<p><b>Late December: Final specifications published</b></p>	<p>NOAA Fisheries approves and publishes the final rule for the following year’s catch and landings limits (if new or modified limits are needed), including any new or revised transfers. During a multi-year specifications review year, if a transfer is newly adopted or revised, rulemaking will likely need to occur even if catch limits do not change.</p>
<p><b>January 1: Fishing year specifications effective, including any transfers</b></p>	<p>Fishing year specifications including any transfers would be effective January 1. <b>No post-implementation reviews or adjustments to the transfer amount would occur</b> given that the final rule would recently have published and recreational measures would have already been considered based on expected post-transfer RHLs.</p>

\*While this step is not directly part of the quota transfer process, the timing of the recreational measures setting process influences the necessary timeline of transfer-related decisions.

Note that while the transfer would occur at the landings limit level (commercial quota and RHL), for the purposes of maintaining accurate accounting and accountability at the ACL level, both sector’s ACLs would be adjusted to reflect the transfer at the landings limit level.

If transfer provisions under alternative 2b are adopted, some changes to the accountability measures (AMs) may also need to be considered. For example, AMs could specify that if the MC determines a transfer caused the donating fishery's ACL, or the combined ABC, to be exceeded, the transfer amount could be deducted from the receiving fishery in a subsequent year. The Council and Board could consider a follow-on action to make these changes if desired. These specific changes are not considered through this Amendment.

**4.2.2 Transfer Cap Alternatives**

Table 28 lists the alternatives under consideration for a cap on the total transfer amount (if any). These alternatives would only be considered if transfer provisions were adopted under alternative 2b above, and would specify a maximum percent of the ABC that could be transferred from one sector to another each year in the form of a landings limit transfer.

**Table 28 Alternatives for annual transfer of quota between the commercial/recreational sectors.**

<b>Annual Quota Transfer Cap Alternatives</b>
<b>2c-1:</b> No transfer cap specified; the Council and Board can recommend any amount of the ABC be transferred between fisheries.
<b>2c-2:</b> Maximum transfer amount set at 5% of the ABC.
<b>2c-3:</b> Maximum transfer amount at 10% of the ABC.
<b>2c-4:</b> Maximum transfer amount set at 15% of the ABC.

**4.3 FRAMEWORK/ADDENDUM PROVISION ALTERNATIVES**

The alternatives in Table 29 consider whether the Council and Board should have the ability to make future changes related to certain issues considered through this Amendment through a framework action (under the Council's FMP) and/or an addendum (for the Commission's FMP). Frameworks/addenda are modifications to the FMPs that are typically (though not always) more efficient than a full amendment. While amendments may take several years to complete and may be more complex, frameworks/addenda can usually be completed in 5-8 months. Both types of management actions include multiple opportunities for public input; however, scoping and public hearings are required for amendments, but are optional for frameworks/addenda. Frameworks/ addenda can only modify existing measures and/or those that have been previously considered in an FMP amendment.

The framework/addenda provisions would apply to commercial/recreational allocation changes (alternative set 1) and quota transfer provisions between the commercial and recreational sectors (alternative set 2). The ability to revise commercial/ recreational allocations through a framework or addendum could make future allocation changes simpler and less time

consuming. The Council adopted an allocation review policy in 2019<sup>7</sup>, where each relevant allocation will be reviewed at least every 10 years; however, the Council may choose to conduct reviews more frequently based on substantial public interest or other factors (including changes in ecological, social, and economic conditions). Framework/addendum provisions are also considered for transfers of quota between sectors, as this may allow for a more efficient management response to changes in the needs of the commercial and recreational fisheries for these species than if these changes needed to be considered through an FMP amendment, as is currently the case.

Allowing such changes through a framework/addendum **does not require or guarantee that this mechanism can be used for future changes**. The Council and Board can always choose to initiate an amendment rather than a framework/addendum if more thorough evaluation or additional public comment opportunities are desired. In addition, if the specific changes under consideration are especially controversial or represent a significant departure from previously considered measures, an amendment may be required, even if the type of change is identified in the FMP as a change that can be made through a framework/addendum.

**Table 29 Framework/addendum provision alternatives.**

Framework/addendum provision alternatives
<b>3a:</b> No action/status quo (no changes to framework/addendum provisions; changes to commercial/recreational allocations must be made through an amendment)
<b>3b:</b> Allow changes to commercial/recreational allocations, annual quota transfers, and other measures included in this Amendment to be made through framework actions/addenda

#### 4.4 IMPACTS OF THE FISHERY MANAGEMENT PROGRAM

This Amendment includes several options which could carry potential biological, social, and economic impacts. **Analysis on impacts for each of the management alternatives can be found in Appendix I.** As described in more detail below, the impacts of these alternatives are expected to be mostly socioeconomic in nature. Potential biological impacts on the summer flounder, scup, and black sea bass stocks are also briefly discussed below. Impacts applicable to all three species are discussed in Section 4.4.1, which species specific impacts are outlined in Sections 4.4.1.1 through 4.4.1.3. A more complete impacts analysis, including consideration of the potential impacts on other components of the environment such as non-target species, habitat, marine mammals, and species listed as threatened or endangered under the Endangered Species Act, will be included in the Environmental Assessment prepared after the Council and Board select their final preferred alternatives.

Sections 4.4.1.1 through 4.4.1.3. contain example projected RHLs and commercial quotas for each allocation alternative to demonstrate potential impacts to the recreational and commercial fisheries. The 2020 ABC for each species was used to project landings limits that

<sup>7</sup> [https://www.mafmc.org/s/MAFMC-Fishery-Allocation-Review-Policy\\_2019-08.pdf](https://www.mafmc.org/s/MAFMC-Fishery-Allocation-Review-Policy_2019-08.pdf)

reflect recent stock size and to allow for comparison to recent fishery performance. The methodology used to develop the example landings limits differs from the methodology that was used to develop the actual landings limits that were implemented for management use in 2020. For the status quo alternatives for each species, the actual 2020 RHLs and commercial quotas are presented. For the other alternatives, use of a different method was necessary to account for several assumptions that must be made about how dead discards by sector would be projected, including the effect that changing allocations could have on each sector's fishing effort and dead discards. A more detailed description of the methodology used to generate example RHLs and quotas can be found in Appendix II.

**Actual future commercial quotas and RHLs under any of these alternatives cannot be determined at this time and may differ from the examples presented here** based on future ABCs, which are unknown beyond 2021 as they are driven by stock assessment projections. In addition, annual assumptions about expected dead discards (total and sector-specific) may vary in future years, which will also impact future RHLs and commercial quotas. The example commercial quotas and RHLs in this document are provided only for the purposes of assessing the potential impacts of each alternative and for comparing between the alternatives.

#### **4.4.1 Recreational and Commercial Allocation Impacts**

##### *Socioeconomic Impacts*

Aside from the no action/status quo alternatives, all alternatives for all three species would result in an increased recreational allocation. This would result in higher RHLs than the current allocations. RHLs are tied to recreational measures such as possession limits, fish size restrictions, and open/closed seasons. These measures are adjusted as needed to allow harvest to meet but not exceed the RHL. Depending on the magnitude of the increase, an increased recreational allocation may not allow for liberalized recreational management measures compared to recent years in all cases. In some cases, recreational restrictions would still be needed if the allocation increase is not enough to account for recent increases in the MRIP harvest estimates.

Liberalizing or restricting recreational measures can impact angler access to all three species. Increased access could take the form of more fish to take home (under higher possession limits or lower minimum fish sizes) and more opportunities to target these species (under longer open seasons), while decreased access could mean the ability to retain fewer fish and reduced opportunities to target these species. This can affect angler satisfaction, revenues for for-hire businesses (e.g., by impacting demand for for-hire trips), and revenues for support businesses such as bait and tackle shops.

At the community level, these impacts may be greatest for communities with or near recreational fishing sites, communities where for-hire businesses are based, and communities with tourism that is impacted by recreational fishing.

Aside from the no action/status quo alternatives, all the alternatives for all three species would result in reduced allocation to the commercial sector, which is expected to result in lower

commercial quotas than the current allocations. The commercial sector may experience a loss in revenue due to corresponding lower quotas and a reduction in potential landings of summer flounder and black sea bass. For scup, this will depend on the degree of the decrease in the quota as the commercial scup quota has not been fully harvested since 2007 due to other factors such as market demand. For all three species, the loss in revenue associated with the reduction in quota is not expected to be linear, as the relationship between price and volume landed in the fishery is not linear and is variable by species. Other factors such as variation in costs can also affect revenue. Some negative impacts associated with quota reductions might be partially offset by the potential for increased prices paid by dealers if decreased quotas result in decreased supply. However, the degree to which this happens depends on the relationship between demand and price.

Impacts from a reduction in commercial quota will not be felt equally across all commercial industry participants. The coastwide commercial quota is divided into state quotas for summer flounder and black sea bass, and seasonal quota periods for scup. Of the three scup quota periods, only the summer period quota is further allocated among states. Some states fully utilize their quota year after year, while other states tend to underutilize their quota. Commercial fishermen from states that fully utilize quota are more likely to experience loss in revenue, restrictive trip limits, and seasonal closures to account for the reduced commercial quota. States that have historically underutilized their quota may still be impacted in the medium- to long-term as reduced access to quota may inhibit the ability for market expansion in the future. These states could also be impacted in the near-term depending on the magnitude of allocation reduction. If the commercial allocation is substantially reduced, quotas in some states may drop below what is currently being utilized.

Lower commercial quotas resulting from lower allocations could result in lower trip limits and shorter seasons. Lower trip limits can incentivize high-grading whereby smaller fish are discarded to allow for more landings of larger fish that can fetch a higher price per pound. Shorter seasons could result in market instability through greater fluctuations in price, as well as “race to fish” conditions if seasons are shortened substantially. A reduction in commercial quotas would not just impact commercial fishermen, it would also reduce the availability of these species to consumers. Changes in commercial allocation of these three species also affects the economic health of communities with notable participation in these commercial fisheries through employment in the harvesting, processing, distribution, and retail aspects of the commercial fisheries. The scale of the impacts will depend on the scale of the change and the degree of local economic dependence on these commercial fisheries.

There are also impacts for both sectors associated with switching from a landings-based allocation (currently implemented for summer flounder and black sea bass) to a catch-based allocation (currently implemented for scup). It could be perceived as a benefit that the catch and landings limits for each sector can be calculated independently from each other under a catch-based allocation. As described in Section 1.3.5, under a catch-based allocation, changes in landings and dead discards in one sector do not influence the other sector’s allocation as the entire ABC is always split among the sectors based on the allocation defined in the FMP,

regardless of recent trends in landings and discards by sector. In theory, this can allow each sector to see the benefits of a reduction in their own dead discards to a greater extent than under a landings-based allocation. Under a catch-based allocation, a reduction in dead discards in one sector can result in an increase in that sector's landings limit in a future year. This was part of the rationale for implementing the current catch-based allocation for scup as it was expected to incentivize a reduction in commercial dead discards, which were of concern during development of Amendment 8 when the commercial/recreational scup allocations were first developed. Under a landings-based allocation, changes in landings and dead discards in one sector can influence the catch and landings limits in both sectors; therefore, the benefits of a reduction in dead discards (or the negative impacts of an increase in dead discards) in one sector can also be felt by the other sector.

Under all alternatives considered in this action, the commercial and recreational sectors will continue to be separately held accountable for overages of their catch and landings limits. There will be no changes to the accountability measures for either sector<sup>8</sup>.

#### *Biological Impacts to Summer Flounder, Scup, and Black Sea Bass Stocks*

As described above, all but the no action/status quo alternatives would reduce the commercial allocations, which would in turn result in lower commercial quotas than the no action/status quo alternatives.

As described in more detail in the species-specific sections below, some alternatives which would increase the recreational allocation may still require additional restrictions in the recreational fisheries compared to the measures used in recent years due to the mismatch between the revised MRIP data and the RHLs which could result from the allocations under many alternatives.

Depending on the scale of the change, a decrease in the commercial quota or additional restrictions on the recreational fishery could lead to increased regulatory discards of these species compared to recent levels. Actual changes in discards will depend on many factors. For example, fishing behavior in both sectors is influenced by many factors in addition to the regulations (e.g., weather, availability of other target species, market demand). Discards are also influenced by availability of each species, both overall abundance and by size class. For example, high availability of fish smaller than the minimum size limit can lead to high regulatory discards. Lower availability of legal-sized fish can lead to decreased discards. For these reasons, it is challenging to predict future discards based on changes in allocations.

In all cases, total dead catch (i.e., landings and dead discards) will continue to be constrained by the overall ABC, which is set based on the best scientific information available and is intended to prevent overfishing. In this way, none of the alternatives are expected to change patterns in

---

<sup>8</sup> A summary of the current accountability measures for summer flounder, scup, and black sea bass can be found at: [https://www.mafmc.org/s/AMs-description\\_SF\\_scup-BSB\\_Dec2020.pdf](https://www.mafmc.org/s/AMs-description_SF_scup-BSB_Dec2020.pdf).

landings, discards, or fishing effort in such a way that they negatively impact stock status for any of the three species.

Landings and discards in the commercial and recreational sectors are monitored and estimated in different ways. A preliminary analysis taking into account the different levels of precision of the estimates of landings and dead discards in each sector for all three species suggests the risk of exceeding the ABC does not vary greatly under a wide range of different proportions of total dead catch from each sector. This suggests changes in the commercial/recreational allocation, especially changes within the range currently under consideration, may not have notably different impacts on the risk of exceeding the ABC.

#### **4.4.1.1 Summer Flounder**

Many stakeholders across regions and fishing modes view the summer flounder recreational minimum size and bag limit to be overly restrictive. Shore-based anglers in particular are concerned about the high minimum size. Depending on the alternative selected and annual considerations, an increase in allocation to the recreational sector may allow for a liberalization of these measures and could increase access to anglers. A reduction in the minimum size limit may be particularly impactful to those who fish from shore and typically encounter smaller fish. Allowing more fish to be retained increases angler satisfaction and provides greater access to fish to bring home to eat.

Table 30 compares example quotas and RHLs under each allocation alternative using the 2020 ABC (see Appendix II for methodology) to the actual quota and RHL implemented in 2020. All alternatives represent an increase in allocation to the recreational sector relative to the no action/status quo alternative (1a-4), and therefore an increase in the RHL. Likewise, each alternative other than the status quo alternative represents a decrease in allocation and resulting commercial quota for the commercial sector. Relative to the actual 2020 limits, example limits would range from no change (under the status quo alternative 1a-4) to a 34% decrease in the commercial quota and 43% increase in the RHL (under alternative 1a-7). Again, these limits are examples. Actual future quotas and RHLs are likely to differ from these examples based on future ABCs, discard assumptions, and other considerations.

Figure 31 compares the example quotas and RHLs (using the 2020 ABC, Table 30) to commercial and recreational landings for summer flounder from 2004 through 2019. Since 2004, landings in each sector have varied with annually varying quotas and RHLs and other factors. In most years since 2004, commercial landings have been above the example commercial quotas, particularly under alternatives 1a-1, 1a-2, 1a-3, 1a-6, and 1a-7. This indicates that if the overall ABC remains similar to 2020, reduced commercial landings may be required relative to most recent years. However, most example quotas are above commercial landings for 2016-2018, indicating that relative to these more recent years, commercial landings may not need to be cut, depending on future ABCs.

For the recreational fishery, harvest in most years since 2004 has been above the example RHLs using the 2020 ABC. However, the example RHLs under most alternatives are higher than



recreational harvest during 2017-2019, meaning that recreational measures may be able to be liberalized relative to these years if ABCs remain similar to 2020 levels, depending on actual RHLs and current and future harvest trends.

As previously stated, the summer flounder commercial quota is further allocated among the states based on allocation percentages defined in the FMP. Starting January 1, 2021, as the result of Amendment 21 to the FMP,<sup>9</sup> the commercial allocations of the summer flounder quota among the states will vary based on the overall coastwide commercial quota amount. When the quota is below 9.55 million pounds, it will be allocated among states based on the states allocations that have been in place since Amendment 2 (1993). Any surplus quota above 9.55 million pounds will be allocated differently. As shown in Table 30, some of the example quotas (using the 2020 ABC as an example for future quotas under recent biomass levels) would be above that threshold while some would fall below. Therefore, some of these alternatives could have implications for how the summer flounder quota is allocated among states.

Along with summer flounder commercial landings potentially varying under the allocation alternatives, ex-vessel prices may also change (Figure 32). Using the equation in Figure 32, prices can be estimated under different landed quantities. For example, assuming full utilization of the example commercial quota in alternative 1a-7 (7.65 million pounds under a 25.03 million pound ABC), the average ex-vessel price is predicted to be \$2.75 per pound and would yield \$21.0 million in total ex-vessel revenue (both in 2019 dollars). If the same process is followed for the alternative 1a-4 example quota (11.10 million pounds), the average ex-vessel price would fall to \$1.82 per pound and revenues would decrease to \$20.2 million, despite the higher quota. These are rough estimates, and price is influenced by many other factors aside from landings, such as changes in consumer preferences or product substitution. This simplified example does offer some limited support that full utilization of the quota under the highest commercial quota alternative may not maximize fishery-wide revenues.

The Council funded a study consisting of an economic model to evaluate the current 60/40 summer flounder landings allocation. The model, developed by Dr. Kurt Schnier (University of California, Merced) and Dr. Rob Hicks (College of William & Mary), aimed to determine which allocations would maximize marginal economic benefits (the marginal value to each sector of an additional pound of summer flounder allocation at a given allocation) to the commercial and recreational sectors. The original model was peer reviewed in November 2016 with a final report completed in 2017.<sup>10</sup> In 2019 and 2020, the model was updated with the revised MRIP estimates released in 2018, as well as more recent commercial fishery data. The results of the updated model suggest that the existing 60/40 commercial/recreational allocation is not suboptimal from an economic efficiency perspective. However, it also suggested that modest

---

<sup>9</sup> See <https://www.mafmc.org/actions/summer-flounder-amendment> for additional information on this Amendment.

<sup>10</sup> The final 2017 report is available at: [https://www.mafmc.org/s/Hicks-Schnier-Summer flounder allocation report final 4 11 2017.pdf](https://www.mafmc.org/s/Hicks-Schnier-Summer%20flounder%20allocation%20report%20final%204%2011%202017.pdf).

allocation changes in either direction would not likely lower the economic benefits received from both sectors of the fishery combined.<sup>11</sup> Using the new recreational data, the value of the fishery to the recreational sector increased relative to the results of the prior report. The point estimate of the recreational sector's marginal willingness to pay is higher and would potentially support higher recreational allocations; however, the confidence intervals for the recreational and commercial sectors' willingness to pay estimates have substantial overlap due to high uncertainty in these estimates, particularly for the recreational sector. This means that due to data limitations, more concrete guidance about optimal allocations could not be generated due to the inability to more precisely estimate the recreational sector's value.

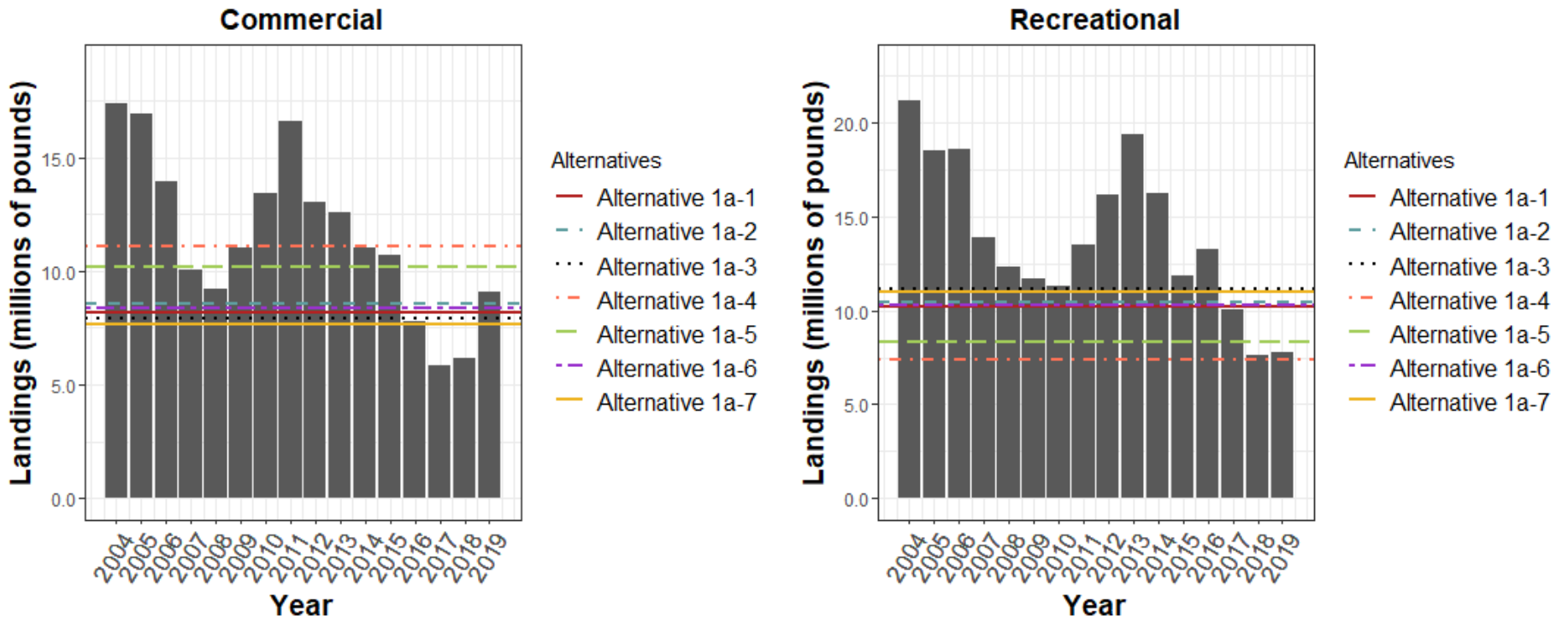
**Table 30. Example commercial quotas and RHLs for each allocation alternative under the 2020 ABC (25.03 million pounds) and the assumptions outlined in Appendix II with comparison to the 2020 implemented limits. Actual future limits will vary based on future ANCs and discard assumptions.**

Alternative	1a-1	1a-2	1a-3	1a-4 <sup>a</sup>	1a-5	1a-6	1a-7
	Catch-based			Landings-based			
Com. allocation	44%	43%	40%	60%	55%	45%	41%
Rec. allocation	56%	57%	60%	40%	45%	55%	59%
Example commercial quota	8.79	8.57	7.92	11.53 <sup>b</sup>	10.20	8.38	7.65
% Difference from 2020 commercial quota	24%	26%	31%	0%	12%	27%	34%
Example RHL	10.24	10.47	11.15	7.69 <sup>b</sup>	8.34	10.25	11.02
% Difference from 2020 RHL	33%	36%	45%	0%	8%	33%	43%

<sup>a</sup> Alternative 1a-4 is the no action/status quo alternative for summer flounder (i.e., the current commercial/recreational allocations).

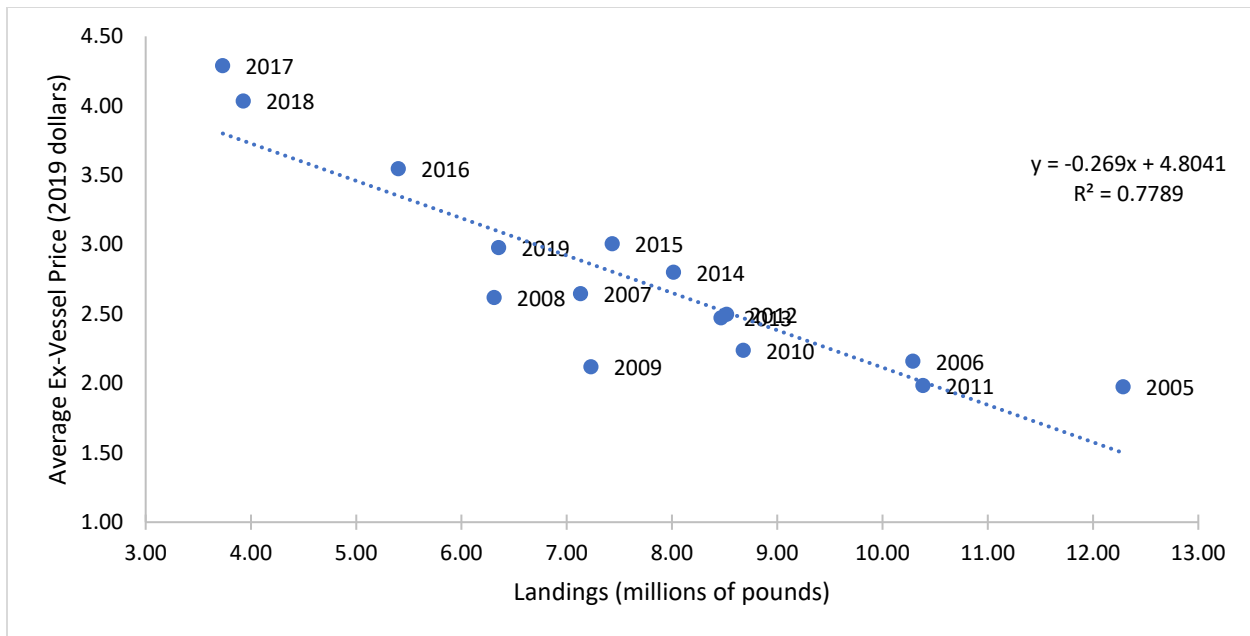
<sup>b</sup> The actual implemented commercial quota and RHL for 2020 are shown under Alternative 1a-4 (no action/status quo).

<sup>11</sup> The updated report (December 2020) is available at: [https://www.mafmc.org/s/Hicks-Schnier\\_Summer\\_Flounder\\_allocation\\_report\\_UPDATE-Dec-2020.pdf](https://www.mafmc.org/s/Hicks-Schnier_Summer_Flounder_allocation_report_UPDATE-Dec-2020.pdf).



*It is important to note that all alternatives under consideration are assuming that the ABC is similar to the 2020 ABC for summer flounder.*

**Figure 31 Recent (2004-2019) commercial and recreational summer flounder landings with comparison to example commercial quotas and RHLs developed using the 2020 ABC (see Appendix II for methodology).**



**Figure 32. Commercial summer flounder landings and average ex-vessel prices, 2005-2019, in 2019 dollars. Source: NEFSC Social Sciences Branch, personal communication.**

#### 4.4.1.2 Scup

Table 31 compares example quotas and RHLs under each allocation alternative using the 2020 ABC (Appendix II for methodology) to the actual quota and RHL implemented in 2020. Relative to the actual 2020 limits, example limits would range from no change (update the status quo/no action alternative 1b-1) to a 33% decrease in the commercial quota and 127% increase in the RHL (under alternative 1b-7). Actual future quotas and RHLs are likely to differ from these examples based on future ANCs, discard assumptions, and other considerations. Figure 33 compared the exemplified quotas and RHLs (using the 2020 ABC, Table 31) to commercial and recreational landings for scup from 2004 through 2019.

Under the no action/status quo alternative for scup (alternative 1b-1), restrictions to the bag limit, minimum size, and/or season would need to be implemented to prevent exceeding the RHL. This is because the revised MRIP harvest estimates for recent years are notably higher than the RHLs that result from the current allocation (assuming recent ABC levels; Figure 33). Alternatives 1b-2 through 1b-7 results in the highest example RHL, and is the only alternative that projects an example RHL that is higher than 2004-2019 recreational harvest (Figure 33). Therefore, alternative 1b-7 would provide the most benefit to the recreational sector in the form of higher angler satisfaction, greater economic opportunity, and more revenue to the for-hire sector compared to the other allocation alternatives. Recreational harvest in recent years is variable in Figure 33, however alternatives 1b-3 through 1b-6 have the potential to allow for harvest at similar levels to recent years.

Alternatives 1b-2 through 1b-7 include lower commercial allocations than the no action/status quo alternative (1b-1). The commercial sector has not fully utilized its quota since 2007 so a

decrease in allocation would not necessarily lead to a decrease in commercial landings or revenues compared to recent levels. Commercial landings from 2004 through 2012 and 2018 through 2019 fall below the example quotas shown in Figure 33 for all alternatives. However, alternatives 1b-2 through 1b-7 may limit the potential for market expansion and future increases in landings and ex-vessel revenue compared to the no action/status quo alternative (1b-1).

In 2018, the scup stock was at 198% of the biomass target level and trending down to the target. The compounding effects of reductions in allocation to the commercial sector combined with a reduction in the overall ABC could result in lower commercial quotas in the future. The reduction in commercial quota under alternatives 1b-2 through 1b-7 may not constrain harvest on a coastwide basis but may negatively impact commercial industry members in states that fully utilize their state quota during the summer scup quota period. Impacts may be felt more equally across states in the winter 1 and 2 period scup fishery with the coastwide trip limit.

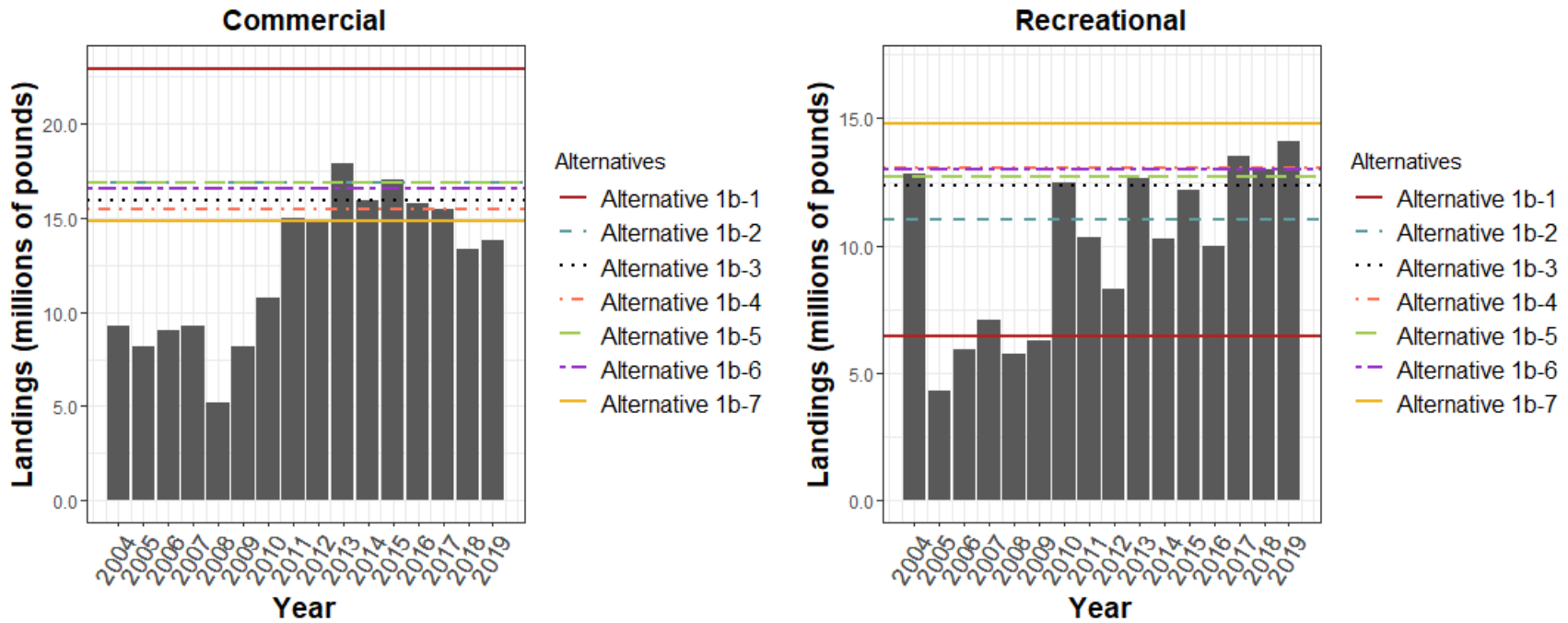
Ex-vessel prices may change if changes in the allocation result in changes in commercial landings (Figure 34). Using the equation in Figure 34, prices can be estimated under different landed quantities. For example, assuming full utilization of the example commercial quota in alternative 1b-7 (14.81 million pounds under a 35.77 million pound ABC), the average ex-vessel price is predicted to be \$0.54 per pound and would yield \$7.9 million in total ex-vessel revenue. Full utilization of the quota under some of the higher quota alternatives, such as 1b-1, would decrease revenues following these methods. Average scup landings over the last three years are 14.20 million pounds, meaning full utilization of the quota would appear unlikely under a number of the allocation alternatives and the current ABC. Based on the price responses to changes in quantity, achieving full utilization of the quota may not be economically desirable for the commercial scup fishery as a whole.

**Table 31. Example commercial quotas and RHLs for each allocation alternative under the 2020 ABC (35.77 million pounds) and the assumptions outlined in Appendix II, with comparison to the 2020 implemented limits. Actual future limits will vary based on future ABCs and discard assumptions.**

Alternative	1b-1 <sup>a</sup>	1b-2	1b-3	1b-4	1b-5	1b-6	1b-7
	Catch-based				Landings-based		
Com. allocation	78%	65%	61%	59%	57%	56%	50%
Rec. allocation	22%	35%	39%	41%	43%	44%	50%
Example commercial quota	22.23 <sup>b</sup>	16.90	15.92	15.44	16.85	16.56	14.81
% Difference from 2017-2019 Com Landings	0%	-24%	-28%	-31%	-24%	-26%	-33%
Example RHL	6.51 <sup>b</sup>	11.04	12.37	13.04	12.71	13.01	14.81
% Difference from 2017-2019 Rec Landings	0%	70%	90%	100%	95%	100%	127%

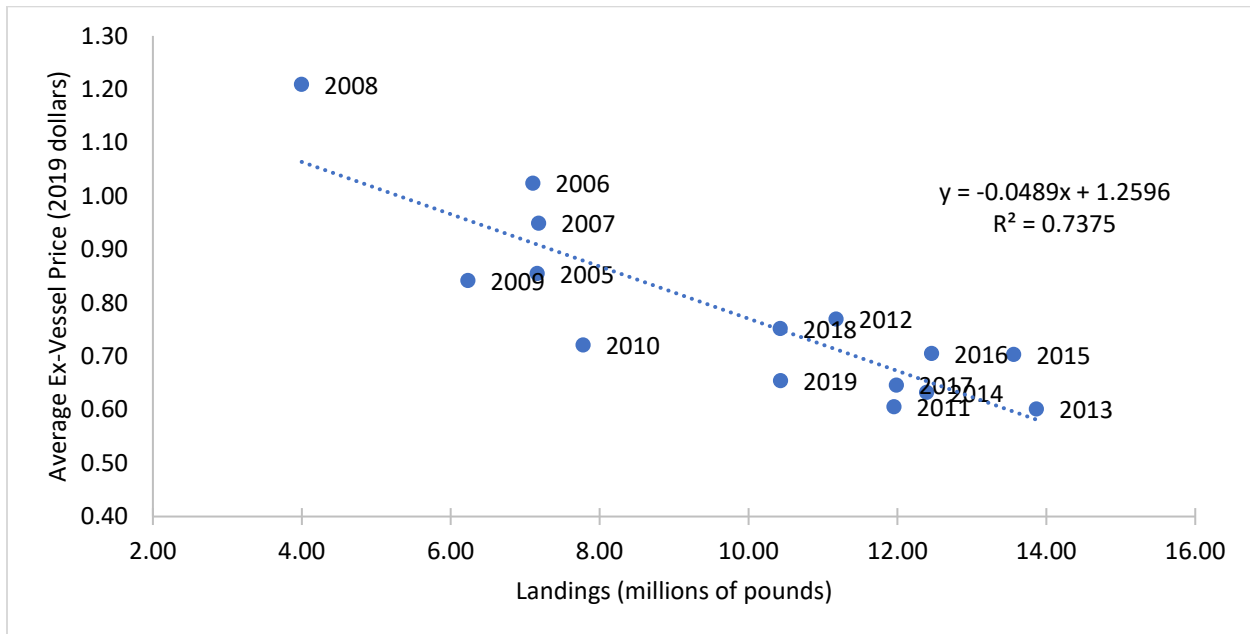
<sup>a</sup> Alternative 1b-1 is the no action/status quo alternative for scup (i.e., the current commercial/recreational allocations).

<sup>b</sup> The actual implemented commercial quota and RHL for 2020 are shown under Alternative 1b-1 (no action/status quo).



*It is important to note that all alternatives under consideration are assuming that the ABC is similar to the 2020 ABC for scup.*

**Figure 33. Recent (2004-2019) commercial and recreational scup landings with comparison to example commercial quotas and RHLs developed using the 2020 ABC (see Appendix II for methodology).**



**Figure 34. Commercial scup landings and average ex-vessel prices, 2005-2019, in 2019 dollars.**  
**Source: NEFSC Social Sciences Branch, personal communication.**

**4.4.1.3 Black Sea Bass**

All black sea bass alternatives, with the exception of the no action/status quo alternative (1c-4) would increase the recreational allocation and decrease the commercial allocation. Table 32 compares example quotas and RHLs under each allocation alternative using the 2020 ANC (see Appendix II for methodology) to the actual quota and RHL implemented in 2020. Relative to the actual 2020 limits, example limits would range from no change (under the status quo/no action alternative 1c-4) to a 53% decrease in the commercial quota and 60% increase in the RHL (under alternative 1c-7). Again, these limits are examples. Actual future quotas and RHLs are likely to differ from these examples based on future ABCs, discard assumptions, and other considerations.

Figure 35 compares the example black sea bass quotas and RHLs (using the 2020 ABC, Table 32) to commercial and recreational landings from 2004 through 2019. Throughout this time period, commercial and recreational landings varied with changes in the landings limits, changes in black sea bass availability, and other factors. It is important to note that all example quotas and RHLs assume that the ABC is similar to the 2020 ABC, which was higher than any previous ABC for black sea bass. In all years shown in Figure 35, the commercial and recreational fisheries operated under landings limits that were set based on ABCs lower than the 2020 ABC.

As shown in Figure 35, commercial landings were below the example quotas under alternatives 1c-4 and 1c-5 during 2004-2019, largely because the fishery was constrained by much lower quotas during those years. The other alternatives result in example quotas that are lower than commercial landings in 2 (alternatives 1c-1 and 1c-6), 4 (alternative 1c-2), or 6 (alternatives 1c-3

and 1c-7) of the 16 years during 2004-2019. The highest commercial landings during this time period occurred during 2017-2019. Therefore, if future ABCs are similar to the 2020 ABC, commercial landings may need to be restricted compared to recent years (i.e. 2017-2019) under all but alternatives 1c-4 and 1c-5. The greatest restrictions would be necessary under alternatives 1c-3 and 1c-7 (Figure 35). Reductions in commercial landings could lead to reduced revenues and negative socioeconomic impacts for commercial fishery participants and support businesses.

Ex-vessel prices for commercial landings may also change in response to the different potential quota levels under each alternative (Figure 36). Using the equation in Figure 36, prices can be estimated under different landed quantities. For example, assuming full utilization of the example commercial quota in alternative 1c-7 (2.61 million pounds under a 15.07 million pound ABC) the average ex-vessel price is estimated to be \$3.25 per pound and would yield \$8.5 million in ex-vessel revenue. If the same process is followed for the alternative 1c-4 example quota (5.43 million lbs.), the average ex-vessel price would fall to \$2.48 per pound. Despite this reduced average price, revenues would continue to increase to \$13.5 million. These are rough estimates, and price is influenced by many other factors aside from landings, such as changes in consumer preferences or product substitution. These results, however, do suggest that black sea bass commercial revenues would increase under higher quotas with full utilization.

As shown in Figure 35, the example RHLs under all alternatives are lower than recreational harvest in at least 3 of the 16 years from 2004-2019. Alternative 1c-4 results in the lowest example RHL, which is lower than harvest during 9 of the 16 years from 2004-2019, followed by alternative 1c-5, which results in an example RHL which is lower than harvest in 8 of the 16 years. However, when considering only 2018-2019, only alternatives 1c-4 and 1c-5 result in example RHLs that are lower than harvest in those years. Therefore, if future ABCs are similar to the 2020 ABC, and depending on future considerations about expected harvest, recreational harvest may not need to be notably restricted compared to recent years (specifically, 2018-2019), under all but alternatives except 1c-4 and 1c-5. Alternatives 1c-4 and 1c-5 could require notable restrictions for the recreational fishery, compared to recent years. Figure 35 suggests that it is not likely that any of the alternatives would allow for increased harvest or notable liberalizations in recreational management measures compared to recent years. Depending on the alternative and annual considerations, all but alternatives 1c-4 and 1c-5 could allow for roughly status quo recreational management measures, or they could require slight to moderate restrictions. As previously stated, more restrictive management measures would be expected to have negative socioeconomic impacts for the recreational sector due to reduced angler satisfaction, reduced demand for for-hire trips, and reduced revenues for for-hire businesses and other recreational fishery support businesses.

Based on the information shown in Figure 35, none of the alternatives would be expected to prevent a need for restrictions in both the recreational and commercial sectors, based on the comparison of example quotas and RHLs against recent landings shown in Figure 35. As previously stated, none of the alternatives are expected to allow for increased recreational harvest compared to recent levels if the ABC remains similar to 2020. The alternatives which,



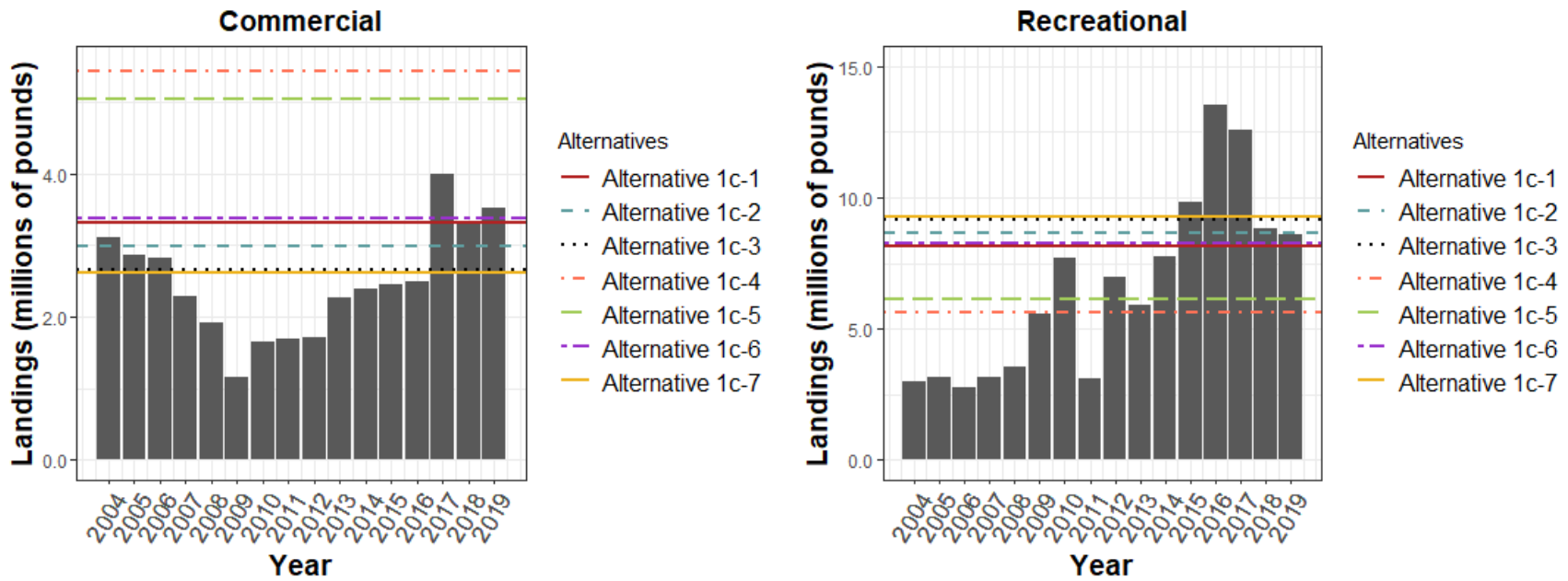
depending on annual considerations, may allow for close to status quo recreational harvest (alternatives 1c-1 through 1c-4, and 1c-6 and 1c-7) would require varying levels of reduction in commercial landings, depending on the alternative, (Figure 35).

**Table 32. Example commercial quotas and RHLs under each allocation alternative using the 2020 ABC (15.07 million pounds) and the assumptions outlined in Appendix II, with comparison to the 2020 limits. Actual future limits will vary based on future ABCs and discard assumptions.**

Alternative	1c-1	1c-2	1c-3	1c-4 <sup>a</sup>	1c-5	1c-6	1c-7
	Catch-Based			Landings-Based			
Com. allocation	32%	28%	24%	49%	45%	29%	22%
Rec. allocation	68%	72%	76%	51%	55%	71%	78%
Example commercial quota	3.31	2.99	2.66	5.58 <sup>b</sup>	5.04	3.38	2.61
% Difference from 2018-2019 com. Landings	-41%	-46%	-52%	0%	-10%	-39%	-53%
Example RHL	8.16	8.65	9.14	5.81 <sup>b</sup>	6.15	8.28	9.27
% Difference from 2018-2019 rec. landings	40%	49%	57%	0%	6%	43%	60%

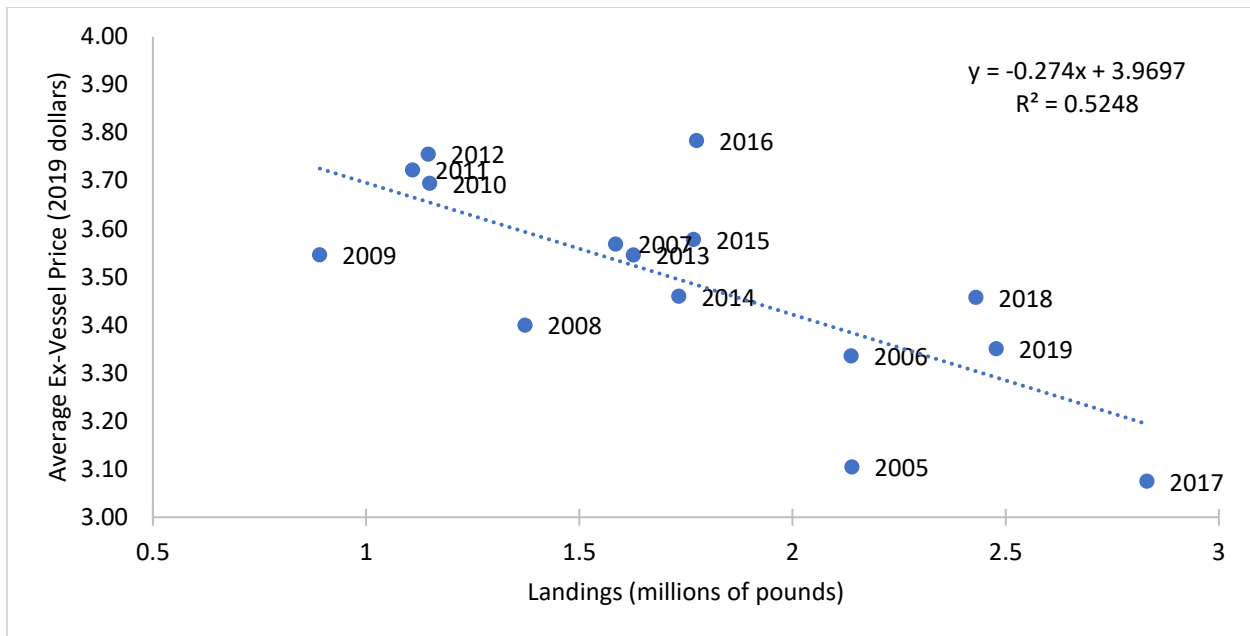
<sup>a</sup> Alternative 1c-4 is the no action/status quo alternative for black sea bass (i.e., the current commercial/recreational allocations).

<sup>b</sup> The actual implemented commercial quota and RHL for 2020 are shown under Alternative 1c-4 (no action/status quo).



*It is important to note that all alternatives under consideration are assuming that the ABC is similar to the 2020 ABC, which was higher than any previous ABC for black sea bass.*

**Figure 35. Recent (2004-2019) commercial and recreational black sea bass landings with comparison to example commercial quotas and RHLs developed using the 2020 ABC (see Appendix II for methodology).**



**Figure 36. Commercial black sea bass landings and average ex-vessel prices, 2005-2019, in 2019 dollars. Source: NEFSC Social Sciences Branch, personal communication.**

#### 4.4.2 Phase-In Alternatives

The biological, social, and economic impacts of the phase-in alternatives are dependent on two things: 1) the difference between the status quo allocation percentage and the allocation percentage selected, and 2) the duration of the phase-in period. Based on the range of allocation percentages across the three species (Section 4.1), the commercial and recreational sector allocations could shift by as much as 13.5% per year, or as little as 0.8% per year under the above phase-in timeframes of 2-5 years. Sections 4.3.2.1 through 4.3.2.3 describe the associated percent shifts per year for each species, and the impacts of these phase-in approaches.

Both catch- and landings-based allocation alternatives are being considered for all three species. As previously stated, summer flounder and black sea bass are currently managed under a landings-based allocation and scup is currently managed under a catch-based allocation. It is straightforward to calculate the annual percent shift in allocation under each phase-in alternative if the allocation remains landings-based for summer flounder and black sea bass or catch-based for scup.

The phase-in transition is more complicated when transitioning from a landings-based to a catch-based allocation or vice versa. Under a landings-based allocation, the division of expected dead discards to each sector is typically calculated using a moving average of recent trends. As a result, under a landings-based allocation, the percentage of the ABC (landings + dead discards) assigned to each sector typically varies from year-to-year and usually does not match the landings-based allocation percent. To illustrate this, the 2021 percent split of landings, dead

discards, and sector ACLs for each species are shown in Table 33. As described below, when transitioning from a landings-based to a catch-based allocation or vice versa, the total and annual phase-in amounts should not be calculated starting from the existing FMP allocation, as the actual split of catch does not match the landings-based allocation for summer flounder and black sea bass, and the actual split of landings does not match the catch-based allocation for scup. The phase-in amounts for each alternative can instead be calculated by using the 2021 measures as a starting point since these are the implemented measures that the transition would be away from. This includes the actual division of catch (for transition to a catch-based allocation) or landings (for transition to a landings-based allocation) in 2021. Additional details for each species are discussed below.

**Table 33 The currently implemented recreational/commercial split for total landings, dead discards, and total dead catch for 2021 specifications. The current FMP-specified allocations for each species are highlighted in yellow.**

<b>Currently Landings-Based Allocations</b>						
	<b>Comm. % of TAL (allocation)</b>	<b>Rec. % of TAL (allocation)</b>	<b>Expected comm. % of discards in 2021</b>	<b>Expected rec. % of discards in 2021</b>	<b>Comm ACL % of ABC in 2021</b>	<b>Rec ACL % of ABC in 2021</b>
<b>Summer flounder</b>	60	40	34	66	54	46
<b>Black sea bass</b>	49	51	68	32	55	45
<b>Currently Catch-Based Allocation</b>						
	<b>Comm. % of TAL in 2021</b>	<b>Rec. % of TAL in 2021</b>	<b>Expected comm. % of discards in 2021</b>	<b>Expected rec. % of discards in 2021</b>	<b>Comm ACL % of ABC (allocation)</b>	<b>Rec ACL % of ABC (allocation)</b>
<b>Scup</b>	74	23	81	19	78	22

NEFSC Social Sciences Branch crew survey results (Table 34) suggest that while a limited number of crew from the summer flounder, scup, and black sea bass fisheries were surveyed, the majority of those surveyed agreed it was hard to keep up with changes in regulations. A phase-in approach to reallocation would still involve regulatory change, though limiting year-to-year change in allocation could possibly make it easier for industry members to adapt to these changes. However, phase-in approaches may also require more frequent changes in management measures such as open seasons and possession limits during the phase-in period. Therefore, consideration should be given to balancing regulatory stability and economic stability.

**Table 34 NEFSC Social Sciences Branch Crew Survey results for reactions to the statement “the rules and regulations change so quickly it is hard to keep up.” Results presented for crew primarily involved in the summer flounder, scup, and black sea bass fisheries over the 2012-2013 survey, 2018-2019 survey, and the combined results.**

Survey Wave	2012-13	2018-19	Total
Strongly agree	3 (27%)	10 (45%)	13 (39%)
Agree	4 (36%)	7 (32%)	11 (33%)
Neutral	1 (9%)	2 (9%)	3 (9%)
Disagree	3 (27%)	3 (14%)	6 (18%)
Strongly disagree	0 (0%)	0 (0%)	0 (0%)
<b>Total</b>	<b>11 (100%)</b>	<b>22 (100%)</b>	<b>33 (100%)</b>

#### **4.4.2.1 Summer Flounder**

If the summer flounder allocation is modified but a landings-based allocation is maintained (alternatives 1a-5 through 1a-7), the annual percent shift amounts are easily calculated by taking the difference between the starting and ending allocations for each sector and evenly dividing that percentage among the 2, 3, or 5 years of phase-in depending on the phase-in alternative (Table 35).

Under a transition from a landings-based to a catch-based allocation (alternatives 1a-1 through 1a-3), dead discards would first need to be incorporated into the current baseline to determine the total and annual percent shift. Any allocation changes adopted are meant to take effect starting in 2022; therefore the specifications for 2021 can serve as this baseline for the current split of catch by sector. Specifically, the percentage of the ABC that each sector will receive in 2021 as a sector ACL is used as the starting point for calculating transition percentages below.

For summer flounder, in 2021, the commercial ACL represents 54% of the ABC and the recreational ACL represents 46% of the ABC (Table 33). From these starting percentages, the total amount of catch-based allocation shift can be calculated, and evenly divided among the 2, 3, or 5 years depending on the phase-in alternative (Table 35).

Across all summer flounder alternatives, the total allocation shift (if allocations are modified) from the commercial to the recreational fishery would range from 5-19% from the current allocations, and the annual phase-in would range from 1.7% per year to 9.5% per year depending on the allocation change and the phase-in alternative selected (Table 35).

As described in Section 4.2, a decline in commercial allocation is expected to lead to a decline in landings and revenue, especially in states where the commercial allocation is fully utilized. The potential decline in landings may result in higher ex-vessel prices due to a price/volume relationship, potentially tempering declines in ex-vessel revenue. The recreational sector for summer flounder is expected to experience positive social and economic impacts under any of the allocation changes proposed in alternatives 1a-1 through 1a-7 (with the exception of the no action/status quo alternative 1a-4). However, the positive impacts may be partially offset by an

inability to meaningfully liberalize measures under a higher allocation given the transition to revised MRIP estimates. The phase-in option selected would affect how quickly these negative and positive impacts are felt by each sector, which could influence how well sector participants are able to adapt to any changes.

For the commercial industry, a more abrupt transition to a revised allocation (alternative 1d-1 and to a lesser extent 1d-2) may result in a sudden loss of income and jobs due to a more sudden drop in revenue in the commercial fishery. Commercial sector participants who are highly dependent on summer flounder may have more difficulty remaining in business while evaluating options for maintaining revenue streams, such as shifting effort to other target species. Alternatives 1d-3 and 1d-4 (a 3- or 5-year phase-in, respectively), would provide a longer transition time for the commercial industry to adapt to loss of fishing opportunity for summer flounder. This could allow for a smoother transition to modified business models such as diversifying target species.

For the recreational fishery, a more abrupt transition to a revised allocation (alternative 1d-1 and to a lesser extent 1d-2) is expected to have social and economic benefits as this allows for a faster transition to an allocation that supports the recent recreational harvest under the revised MRIP data (Figure 31). This has implications for recreational management measures, which could be liberalized more quickly if a faster transition to a revised allocation occurs. For summer flounder recent recreational harvest under the revised MRIP estimates are at similar levels as recent RHLs, so it is possible that recreational measures could be liberalized in the coming years if allocation to the recreational sector is increased (e.g Figure 31). However, this is also dependent on future projections of stock biomass, trends in recreational catch and effort, and other factors. If recreational measures can be liberalized, this could result in a decrease in recreational discards. Alternatives 1d-3 and 1d-4 (a 3- or 5-year phase-in, respectively), would provide a longer transition to an increased recreational allocation for summer flounder. This may mean recreational measures and fishing opportunities could be maintained at current levels for longer, or liberalized more slowly, though it is important to note that possible liberalizations depend on many different factors and are not guaranteed.

**Table 35. Percent shift in summer flounder allocation per year for 2, 3, and 5 year phase-in options for all summer flounder allocation change alternatives.**

<b>Catch-Based Alternatives</b>	<b>Total amount of allocation percent shift needed<sup>a</sup></b>	<b>1d-2: 2 year phase-in</b>	<b>1d-3: 3 year phase-in</b>	<b>1d-4: 5 year phase-in</b>
<b>1a-1: 44% commercial, 56% recreational</b>	<b>10%</b>	<b>5% shift per year</b>	<b>3.3% shift per year</b>	<b>2% shift per year</b>
<b>1a-2: 43% commercial, 57% recreational</b>	<b>11%</b>	<b>5.5% shift per year</b>	<b>3.7% shift per year</b>	<b>2.2% shift per year</b>
<b>1a-3: 40% commercial, 60% recreational</b>	<b>14%</b>	<b>7% shift per year</b>	<b>4.7% shift per year</b>	<b>2.8% shift per year</b>
<b>Landings-Based Alternatives</b>	<b>Total amount of allocation percent shift needed<sup>b</sup></b>	<b>1d-2: 2 year phase-in</b>	<b>1d-3: 3 year phase-in</b>	<b>1d-4: 5 year phase-in</b>
<b>1a-4 (status quo): 60% commercial, 40% recreational</b>	<b>0%</b>	<b>N/A</b>	<b>N/A</b>	<b>N/A</b>
<b>1a-5: 55% commercial, 45% recreational</b>	<b>5%</b>	<b>2.5% shift per year</b>	<b>1.7% shift per year</b>	<b>1% shift per year</b>
<b>1a-6: 45% commercial, 55% recreational</b>	<b>15%</b>	<b>7.5% shift per year</b>	<b>5% shift per year</b>	<b>3% shift per year</b>
<b>1a-7: 41% commercial, 59% recreational</b>	<b>19%</b>	<b>9.5% shift per year</b>	<b>6.3% shift per year</b>	<b>3.8% shift per year</b>

<sup>a</sup> For catch-based alternatives, the starting point for this calculation is the current (2021) split of the sector-specific ACLs (which incorporates dead discards) instead of the landings limit allocation. Here, this shift is calculated by starting from the 2021 specifications which includes a commercial ACL that is 54% of the ABC, and a recreational ACL that is 46% of the ABC.

<sup>b</sup> For landings-based alternatives, the starting point for this calculation is the specified landings-based allocation (60% commercial/40% recreational). This does not account for dead discards, which would continue to be split using different methods with the resulting percentages varying depending on the year.

#### **4.4.2.2 Scup**

The current allocation for scup is catch-based. If the allocation is modified but a catch-based allocation is maintained (alternatives 1b-2 through 1b-4), the annual percent shift amounts are easily calculated by taking the difference between the starting and ending allocations for each sector and evenly dividing that percentage among the 2, 3, or 5 years of phase-in depending on the phase-in alternative (Table 36).

Under a transition from a catch-based to a landings-based allocation (alternatives 1b-5 through 1b-7), dead discards would first need to be separated from the current baseline to determine the total and annual percent allocation shift. Because any allocation changes adopted are

## DRAFT AMENDMENT FOR PUBLIC COMMENT

meant to take effect starting in 2022, the specifications for 2021 can serve as this baseline for the current split of landings by sector. Specifically, the percentage of the total allowable landings (TAL) that each sector will receive in 2021 as sector landings limits (commercial quota and RHL) is used as the starting point for calculating transition percentages below (Table 33).

For scup, in 2021, the commercial quota represents 77% of the TAL and the RHL represents 23% of the TAL (Table 33). From these starting percentages, the total amount of landings-based allocation shift can be calculated, and evenly divided among the 2, 3, or 5 years depending on the phase-in alternative (Table 36).

Across all the alternatives for scup, the total allocation shift needed (if allocations are modified) from the commercial to the recreational fishery would range from 13-27% from current allocations, and the annual phase-in would range from 2.6% per year to 13.5% per year depending on the allocation change and the phase-in alternative selected (Table 36).

As described in Section 4.2, depending on the scale of the change, a decline in commercial allocation could lead to loss of revenue from scup or it may not impact revenues as commercial landings have been below the full allowed amount for several years due to market factors. Any potential loss in revenue for fishermen may be partially offset by increases prices paid by dealers if a price/volume relationship impacts prices under lower quotas (Figure 34). The recreational sector is expected to experience positive social and economic impacts under any of the allocation changes proposed in alternatives 1b-1 through 1b-7 (with the exception of the no action/status quo alternative 1b-1). However, the positive impacts may be partially offset by an inability to meaningfully liberalize measures under a higher allocation given the transition to revised MRIP estimates (Figure 33). The phase-in option selected would affect how quickly these negative and positive impacts are felt by each sector, which could influence how well sector participants are able to adapt to any changes.

For the commercial industry, a more abrupt transition to a revised allocation (alternative 1d-1 and to a lesser extent 1d-2) may result in a more sudden loss of income and jobs due to a more sudden drop in revenue. Commercial sector participants who are highly dependent on scup may have more difficulty remaining in business while evaluating options for maintaining revenue streams, such as shifting effort to other target species. Alternatives 1d-3 and 1d-4 (a 3- or 5-year phase-in, respectively), would provide a longer transition time for the commercial industry to adapt to loss of fishing opportunity for scup. This could allow for a smoother transition to modified business models such as diversifying target species.

For the recreational fishery, a more abrupt transition to a revised allocation (alternative 1d-1 and to a lesser extent 1d-2) is expected to have positive social and economic benefits as this allows for a faster transition to an allocation that matches the recent recreational harvest under the revised MRIP data. This has implications for recreational management measures, which for scup, are currently resulting in harvest levels higher than the current RHL. Under the current allocation, this should require more restrictive measures to be implemented for the recreational fishery. However, under an increased allocation to the recreational fishery, it is possible that recreational scup measures could remain the same (avoiding severe restrictions



DRAFT AMENDMENT FOR PUBLIC COMMENT

that would otherwise be taken). Recreational measures are also dependent on factors such as future projections of stock biomass, trends in recreational catch and effort, and other trends. It is possible that if scup biomass is projected to increase in the coming years, recreational measures may be able to be liberalized under an increased allocation. Alternatives 1d-3 and 1d-4 (a 3- or 5-year phase-in, respectively), would provide a longer transition to an increased recreational allocation for scup. This is likely to mean that recreational measures and fishing opportunities will need to be restricted during the transition years, possibly severely given recent MRIP estimates, though it is important to note that adjustments to recreational measures depend on many different factors.

Table 36. Percent shift in scup allocation per year for 2, 3, and 5 year phase-in options for all scup allocation change alternatives.

Catch-Based Alternatives	Total amount of allocation percent shift needed <sup>a</sup>	1d-2: 2 year phase-in	1d-3: 3 year phase-in	1d-4: 5 year phase -in
<b>1b-1 (status quo): 78% commercial, 22% recreational</b>	<b>0%</b>	<b>N/A</b>	<b>N/A</b>	<b>N/A</b>
<b>1b-2: 65% commercial, 35% recreational</b>	<b>13%</b>	<b>6.5% shift per year</b>	<b>4.3% shift per year</b>	<b>2.6% shift per year</b>
<b>1b-3: 61% commercial, 39% recreational</b>	<b>17%</b>	<b>8.5% shift per year</b>	<b>5.7% shift per year</b>	<b>3.4% shift per year</b>
<b>1b-4: 59% commercial, 41% recreational</b>	<b>19%</b>	<b>9.5% shift per year</b>	<b>6.3% shift per year</b>	<b>3.8% shift per year</b>
Landings-Based Alternatives	Total amount of allocation percent shift needed <sup>b</sup>	1d-2: 2 year phase-in	1d-3: 3 year phase-in	1d-4: 5 year phase -in
<b>1b-5: 57% commercial, 43% recreational</b>	<b>20%</b>	<b>10% shift per year</b>	<b>6.7% shift per year</b>	<b>3.4% shift per year</b>
<b>1b-6: 56% commercial, 44% recreational</b>	<b>21%</b>	<b>10.5% shift per year</b>	<b>7% shift per year</b>	<b>4 % shift per year</b>
<b>1b-7: 50% commercial, 50% recreational</b>	<b>27%</b>	<b>13.5% shift per year</b>	<b>9% shift per year</b>	<b>5.4% shift per year</b>

<sup>a</sup> For catch-based alternatives, the starting point for this calculation is the FMP-specified allocation percentage (78% commercial/22% recreational).

<sup>b</sup> For landings-based alternatives, the starting point for this calculation is the current (2021) split of the sector-specific landings limits (commercial quota and RHL). Here, this shift is calculated by starting from the 2021 specifications which includes a commercial quota that is 77% of the total allowable landings, and an RHL that is 23% of the total allowable landings (Table 33). This does not account for dead discards, which going forward would be split using different methods with the resulting percentages varying depending on the year.

#### **4.4.2.3 Black Sea Bass**

If the black sea bass allocation is modified but a landings-based allocation is maintained (alternatives 1c-5 through 1c-7), the annual percent shift amounts are easily calculated by taking the difference between the starting and ending allocations for each sector and evenly dividing that percentage among the 2, 3, or 5 years of phase-in depending on the phase-in alternative (Table 37).

Under a transition from a landings-based to a catch-based allocation (alternatives 1c-1 through 1c-3), dead discards would first need to be incorporated into the current baseline to determine the total and annual percent shift. Specifications for 2021 can serve as this baseline for the current split of catch by sector. Specifically, the percentage of the ABC that each sector will receive in 2021 as a sector ACL is used as the starting point for calculating transition percentages below (Table 37).

For black sea bass, in 2021, the commercial ACL represents 55% of the ABC and the recreational ACL represents 45% of the ABC (Table 37). From these starting percentages, the total amount of allocation shift can be calculated, and evenly divided among the 2, 3, or 5 years depending on the phase-in alternative (Table 37).

Across all the alternatives for black sea bass, the total allocation shift needed (if allocations are modified) from the commercial to the recreational fishery would range from 4-31%, compared to the current allocations, and the annual phase-in would range from 0.8% per year to 15.5% per year depending on the allocation change and the phase-in alternative selected (Table 37).

As described in Section 4.2, a reduced commercial allocation is expected to lead to loss of revenue, depending on the magnitude of the allocation change, especially in states where the commercial allocation is fully utilized. However, the potential loss in revenue may be partially offset by an increase in prices paid by dealers to fishermen if a price/volume relationship impacts prices under lower landings (Figure 36). The recreational sector is expected to experience positive social and economic impacts under any of the allocation changes proposed in alternatives 1c-1 through 1c-7 (with the exception of the no action/status quo alternative 1c-4). However, the positive impacts may be partially offset by an inability to meaningfully liberalize recreational management measures under a higher allocation given the transition to revised MRIP estimates, depending on the alternative (Figure 35). The phase-in option selected would affect how quickly these negative and positive impacts are felt by each sector, which could influence how well sector participants are able to adapt to any changes. For both sectors, these impacts will vary depending on the magnitude of the total allocation change, as well as the length of the phase-in period.

For the commercial industry, a more abrupt transition to a revised allocation (alternative 1d-1 and to a lesser extent 1d-2) may result in a sudden loss of income and jobs due to a more sudden drop in revenue in the commercial fishery. Commercial sector participants who are highly dependent on black sea bass may have more difficulty remaining in business while evaluating options for maintaining revenue streams, such as shifting effort to other target

species. Alternatives 1d-3 and 1d-4 (a 3- or 5-year phase-in, respectively), would provide a longer transition time for the commercial industry to adapt to loss of fishing opportunity for black sea bass. This could allow for a smoother transition to modified business models such as diversifying target species.

For the recreational fishery, a more abrupt transition to a revised allocation (alternative 1d-1 and to a lesser extent 1d-2) could have social and economic benefits as this would allow for a faster transition to an allocation that matches the recent recreational harvest under the revised MRIP data. This has implications for recreational management measures, which for black sea bass, are currently resulting in harvest levels much higher than the current RHL. If the current allocation, is maintained more restrictive measures may need to be implemented to constrain harvest to the RHL. Under an increased allocation to the recreational fishery, it is possible that recreational black sea bass measures could remain the same (avoiding severe restrictions that could otherwise be required; Figure 35). Recreational measures are also dependent on factors such as future projections of stock biomass, trends in recreational catch and effort, and other trends. It is possible that if black sea bass biomass is projected to increase in the coming years and this allows for a higher ABC, recreational measures could be liberalized under an increased allocation. Alternatively, further restrictions could be needed if the ANC decreases. Alternatives 1d-3 and 1d-4 (a 3- or 5-year phase-in, respectively), would provide a longer transition to an increased recreational allocation for black sea bass. This could mean that recreational measures and fishing opportunities will need to be restricted during the transition years, possibly severely given recent MRIP estimates (Figure 35), though it is important to note that adjustments to recreational measures depend on many different factors.

**Table 37. Percent shift in black sea bass allocation per year for 2, 3, and 5 year phase-in options for all black sea bass allocation change alternatives.**

Catch-Based Alternatives	Total amount of allocation percent shift needed <sup>a</sup>	1d-2: 2 year phase-in	1d-3: 3 year phase-in	1d-4: 5 year phase-in
<b>1c-1: 32% commercial, 68% recreational</b>	<b>23%</b>	<b>11.5% shift per year</b>	<b>7.7% shift per year</b>	<b>4.6% shift per year</b>
<b>1c-2: 28% commercial, 72% recreational</b>	<b>27%</b>	<b>13.5% shift per year</b>	<b>9.0% shift per year</b>	<b>5.4% shift per year</b>
<b>1c-3: 24% commercial, 76% recreational</b>	<b>31%</b>	<b>15.5% shift per year</b>	<b>10.3% shift per year</b>	<b>6.2% shift per year</b>
Landings-Based Alternatives	Total amount of allocation percent shift needed <sup>b</sup>	1d-2: 2 year phase-in	1d-3: 3 year phase-in	1d-4: 5 year phase-in
<b>1c-4 (status quo): 49% commercial, 51% recreational</b>	<b>0%</b>	<b>N/A</b>	<b>N/A</b>	<b>N/A</b>
<b>1c-5: 45% commercial, 55% recreational</b>	<b>4%</b>	<b>2% shift per year</b>	<b>1.3% shift per year</b>	<b>0.8% shift per year</b>
<b>1c-6: 29% commercial, 71% recreational</b>	<b>20%</b>	<b>10% shift per year</b>	<b>6.7% shift per year</b>	<b>4% shift per year</b>
<b>1c-7: 22% commercial, 78% recreational</b>	<b>27%</b>	<b>13.5% shift per year</b>	<b>9% shift per year</b>	<b>5.4% shift per year</b>

<sup>a</sup> For catch-based alternatives, the starting point for this calculation is the current (2021) split of the sector-specific ACLs (which incorporates dead discards) instead of the landings limit allocation. Here, this shift is calculated by starting from the 2021 specifications which includes a commercial ACL that is 55% of the ABC, and a recreational ACL that is 45% of the ABC for black sea bass (Table 33).

<sup>b</sup> For landings-based alternatives, the starting point for this calculation is the specified landings-based allocation (49% commercial/51% recreational). This does not account for dead discards, which would continue to be split using different methods with the resulting percentages varying depending on the year.

#### 4.4.3 Transfer Impacts

A major disadvantage of the process proposed in Section 4.2.1 is that it requires an annual evaluation of the need for a transfer in the upcoming year using data from the previous year (and potentially older data). Because in-year landings projections are not feasible with this timeline, this would cause at least a two-year disconnect in the timing of the data used to evaluate the need for transfer and the year in which the transfer would apply. This could result in a mismatch between the recommended transfer amount and direction and the reality of the fishery conditions and needs for the upcoming year.

## DRAFT AMENDMENT FOR PUBLIC COMMENT

The need for a transfer in any given year may be difficult to determine, due to several factors in addition to the timing of the data availability described above. These fisheries (particularly summer flounder and black sea bass) tend to fully or mostly utilize their allocation and sometimes experience overages. Annual changes in management measures are sometimes needed (especially in the recreational fisheries), and the effects of both past and expected future changes on expected harvest must be considered when determining a transfer amount. It is also difficult to predict changes in market factors that may influence whether the commercial fishery would utilize additional quota or has quota to spare.

Past sector performance for these fisheries may not be very informative when it comes to determining how often transfers will be needed. Because the recreational data currency has recently changed, pre-revision MRIP performance relative to the RHLs is not likely to be useful since the changes were not a simple linear scaling. In addition, any allocation changes implemented through this action may reduce the need for transfers. For these reasons, predicting the need for a transfer may be more straightforward in the future after additional years of evaluating harvest against catch and landings limits set in the new MRIP currency, and after any allocation changes implemented through this action have been in place for a few years. In this way, the ability to use transfers may be a useful “tool in the toolbox” for future years, as opposed to an option that is likely to be used in the more immediate future.

Looking solely at past trends in sector performance, transfer provisions may be most useful for the scup fishery given that the commercial quota has not been fully utilized for several years, but again, it is difficult to determine future transfer needs given the many uncertainties discussed here.

The MC recommendations for a transfer amount and direction would be based on an expected set of landings limits which would not yet have been reviewed or adopted by the Council and Board (Table 27). If these landings limits are modified by either the Council and Board or NMFS (e.g. if NMFS determines that a modification is necessary to account for a past year’s overage), the MC’s transfer recommendation may no longer be appropriate and it could be difficult for the Council and Board to adopt a modified transfer in time for the upcoming fishing year. The intent is that any transfer would be implemented before January 1 of the relevant fishing year, meaning that a mid-year quota change due to a transfer is not expected.

The conclusion about whether a transfer is needed could result in increased political discussion and potentially increased tensions between sectors during the specifications setting or review process.

As described in Section 5.1.1, recreational measures (typically determined in December) would need to be set using the expected post-transfer RHL. While typically there are no changes to the Council and Board’s adopted RHL during the implementation process, it is possible that NOAA Fisheries may change the RHL if circumstances require such modifications, such as if a recreational payback for an ACL overage is required. In practice, this may not represent a problem, since recreational measures are typically set based on the expected RHL. However,

the use of transfers may further complicate this process if NOAA Fisheries modifies or does not adopt the Council and Board recommendation for transfer.

If the Council and Board determine that the ability to use transfers during specifications is not desired, they could consider allowing for temporary transfers via FMP frameworks/addenda instead. This could be specified through alternative set 3 (Section 6.0). Annual transfers through a framework/addendum process would provide some additional flexibility in adapting to changing sector needs but would not allow for as timely of a response as would be possible through the specifications process.

#### ***4.4.3.1 Socioeconomic Impacts of Transfers***

The impacts of transfers depend on the frequency of transfer, the amount transferred in each year, the direction of transfer between sectors, and to what extent each sector has been or is expected to achieve their limits. The impacts of a transfer are also dependent on the marginal economic value of additional allowable landings for each sector (in terms of commercial and for-hire revenues and revenues for associated commercial and recreational businesses), as well as the positive or negative impacts on angler satisfaction that may arise from modifying or maintaining recreational measures. As described below, many additional factors can influence how the commercial and recreational fisheries may be impacted by a transfer, including market conditions, overall availability of the species, availability of substitute species, and trends in effort driven by external factors.

##### *Commercial to Recreational Transfers*

If the recreational fishery receives a transfer, they would experience positive socioeconomic impacts due to outcomes such as the potential for liberalized measures, the ability to maintain status quo measures when a restriction may otherwise be needed, and/or a reduced risk of an RHL or ACL overage that may impose negative consequences in a future year. These outcomes could result in maintained or increased revenues for recreational businesses as well as improved or maintained levels of angler satisfaction, compared to if no commercial to recreational transfer occurred.

In this scenario, the commercial sector would give up quota that is not expected to be fully utilized. In theory, if the decision to transfer is based on a pattern of underutilization in the commercial sector, the economic impacts to the commercial sector from such a transfer would be neutral. However, the commercial sector could experience a loss in revenue if the potential for underutilization is incorrectly evaluated. This could be due to a disconnect in the data used to evaluate the transfer and conditions in the relevant fishing year, possibly driven by changes in market conditions or fishery participation and effort.

Impacts to the commercial fisheries are not likely to be felt equally across states given different commercial quota management systems and differing quota utilizations by state. While coastwide commercial landings can fall short of the total commercial quota, individual states vary considerably in utilizing or underutilizing their individual quotas. A coastwide projected

underutilization could occur even if one or more states would be expected to fully utilize their quota in the upcoming year. This could have negative economic impacts to the commercial industries in states that regularly achieve their quotas.

#### *Recreational to Commercial Transfers*

If the commercial fishery receives a transfer, they would experience positive socioeconomic impacts in the year of the transfer due to increased revenue earning potential associated with higher potential landings. In general, quota increases tend to result in higher revenues, although some of these benefits may be partially offset by decreases in price per pound that can be associated with higher quotas. As described in Section 4.2, average ex-vessel price for each species tends to decrease with increasing landings. This relationship depends on the magnitude of the change in quota as well as other market factors in addition to total landings, so this relationship is difficult to predict. The relationship is also stronger for summer flounder and scup compared to black sea bass, so positive impacts of the commercial sector receiving a transfer are likely to be greater for black sea bass.

In theory, if the decision to transfer is based on a pattern of underutilization by the recreational sector, negative socioeconomic impacts to the recreational sector from such a transfer may not be realized. However, this would limit the potential for liberalizing recreational management measures. For these species, particularly for summer flounder and black sea bass, many stakeholders are of the opinion that recreational measures are currently overly restrictive. Because recreational harvest is more difficult to predict and control than commercial harvest, recreational management measures are frequently adjusted in order to strike an appropriate balance between conservation and angler satisfaction. Therefore, it may be less likely that a recreational to commercial transfer would actually occur.

#### *Impacts of Transfers in Either Direction*

The impacts of transfers should be considered in combination with the short-term and long-term impacts associated with commercial/recreational allocation modifications under alternative set 1. However, it is difficult to do so quantitatively given the uncertainties about allocation changes as well as the uncertainties in the frequency, amount, and direction of potential transfers. In general, any annual transfers away from a sector can compound the negative impacts experienced due to a reduction in that sector's total allocation, or in the short term could partially offset the positive impacts of an increase in allocation. Annual transfers to a sector can simultaneously create additional positive impacts on top of the positive impacts of reallocation from the perspective of the receiving sector, and also exacerbate negative impacts of a loss in allocation for the donating sector.

The impacts of transfers would also be influenced by annual reductions or increases in the overall ABC based on changes in projected stock biomass and the application of the Council's risk policy. The recipient of a transfer could have some negative socioeconomic impacts from ABC reductions mitigated by receiving a transfer, while the transferring sector may experience

exacerbated negative economic impacts from ABC reductions. Conversely, if the ABC were increasing, this could offset negative impacts to the transferring sector and provide additional benefits to the sector receiving the transfer.

As described above, the impacts of transfers may differ by state or region. For the commercial industry, the negative impacts associated with losing quota or the positive impacts associated with receiving a transfer are influenced by the method of quota allocation for each species. For summer flounder, commercial quota allocation will be revised as of January 1, 2021, and the state allocations are will then be tied to the overall coastwide commercial quota amount. This means that a transfer to or from the commercial quota could influence whether the coastwide commercial quota is above or below the quota threshold for modified allocations, which is currently specified at 9.55 million pounds. For black sea bass, a management action to potentially revise state commercial allocations is currently in development but a preferred alternative has not been identified, so it is difficult to predict the state or regional impacts of proposed quota transfers in combination with potential state allocation changes.

The impacts of transfers can also be impacted by the availability and management of substitute species for a particular sector. High availability and access to recreational or commercial substitute species would help mitigate negative impacts of a transfer away from a given sector, while lower availability and access would compound these negative effects.

Availability of a target species in a given year can also affect the outcome of a transfer, in the sense that availability influences catch rates and search costs associated with commercial and recreational trips. In general, it has been more difficult to calibrate recreational measures to constrain catch below the target level when availability for a species is high. This could drive managers to adopt commercial-to-recreational transfers more frequently under high availability conditions in order to avoid recreational overages.

#### ***4.4.3.2 Impacts to Transfer Cap Alternatives***

Alternative set 2c (Section 4.2.1) contains options for setting a cap on the total amount of transfer between sectors, as a percentage of the ABC.

Alternative 2c-1 would specify that there is no transfer cap, meaning the Council and Board could recommend any amount of the ABC be transferred between sectors during the annual specifications process. This allows for maximum flexibility in changing the effective allocation in each year; however, this is also associated with a higher likelihood of politically contentious discussions during the annual specifications setting process and greater uncertainty about future effective sector allocations. The Council and Board could effectively consider large temporary reallocations on an annual basis. No transfer cap could also mean a very wide range of potential transfer amounts to consider and analyze. This could lead to less predictability and more frequent fluctuations in sector-specific landings limits from year to year, which could be amplified by changes in overall catch limits resulting from fluctuating stock projections. This could partially negate some of the positive impacts experienced by the sector receiving



transfers, given that it could mean their adjustments in the following year may be more severe than if a transfer did not occur the prior year.

Alternatives 2c-2, 2c-3, and 2c-4 provide options for transfer caps set at 5%, 10%, and 15% of the ABC, respectively. This would provide less flexibility in adapting to circumstances where there may be a surplus of allocation in one sector but a deficit in the other. However, a transfer cap also limits consideration of larger allocation transfers through the specifications process and would limit the politically contentious nature of this discussion and provide greater certainty in the effective sector allocations. Transfer caps would limit the allocation changes that could occur from year to year. Transfer caps would somewhat streamline the process of transfer consideration given that it would limit the range of what could be considered. A lower transfer cap (alternative 2c-2) would accomplish this more so than a larger cap (alternative 2c-4).

Under all alternatives, increased fluctuation in allocation from year to year could increase instability and unpredictability in landing limits, which could partially negate the positive impacts from a transfer even if a cap is in place, although transfer caps under alternatives 2c-2 through 2c-4 would lower the likelihood or severity of this, particularly if the cap is lower.

Under all transfer alternatives, if larger and/or more frequent transfers are adopted, this may indicate that the allocation is not properly specified in the FMP and consideration should be given to modifications to the allocation percentages.

Table 38 shows 5%, 10%, and 15% transfer caps in millions of pounds under the 2017-2021 high and low ABCs for each species. This is meant to provide an example of the amounts that could have been transferred between sectors under recent high and low ABCs. This does not represent a theoretical minimum or maximum amount of quota transfer in pounds, given that the transfer cap alternatives are specified as a percent of the ABC and will vary as ABCs change.

Between 2017-2021, alternative 2c-2 (5% cap) would have resulted in a cap between 0.45 and 1.96 million pounds depending on the species and year. Alternative 2c-3 (10% cap) would have resulted in a cap between 0.89 and 3.91 million pounds depending on the species and year. Alternative 2c-4 (15% cap) would have resulted in a cap between 1.34 and 5.87 million pounds depending on the species and year. Over this time period, scup would have had the highest average transfer cap given the highest average ABC, followed by summer flounder and then black sea bass.

**Table 38. Example transfer caps under alternatives 2c-2 through 2c-4 for the 2017-2021 high and low ABCs for each species, in millions of pounds. Note that these are only examples using recent ABCs and do not represent a theoretical maximum or minimum transfer am**

		Summer Flounder	Scup	Black Sea Bass
ABC for comparison	2017-2021 Low ABC	11.30	28.40	8.94
	2017-2021 High ABC	27.11	39.14	17.45
2c-2: 5% of ABC	2017-2021 Low Transfer Cap	0.57	1.42	0.45
	2017-2021 High Transfer Cap	1.36	1.96	0.87
2c-3: 10% of ABC	2017-2021 Low Transfer Cap	1.13	2.84	0.89
	2017-2021 High Transfer Cap	2.71	3.91	1.75
2c-4: 15% of ABC	2017-2021 Low Transfer Cap	1.70	4.26	1.34
	2017-2021 High Transfer Cap	4.07	5.87	2.62

**4.4.4 Impacts of Framework/Addendum Provision Alternatives**

The impacts of alternatives 3a and 3b are briefly described below. These alternatives are primarily procedural in nature. The purpose of modifying the list of “frameworkable items” in the FMP is to demonstrate that the concepts included on the list have previously been considered in an amendment (i.e., they are not novel).

Alternative 3a would make no changes to the current list of framework provisions in the Council's FMP and no changes to the current list of measures subject to change under adaptive management in the Commission’s FMP. Any future proposed modifications to the commercial/recreational allocations or proposed allocation transfer systems would likely require a full FMP amendment. The timeline and complexity of such an amendment would depend on the nature of the specific options considered.

Alternative 3b would allow changes to commercial/recreational allocations and sector allocation transfer provisions to be implemented through a framework action (for the Council) and/or an FMP addendum (for the Commission). This alternative is intended to simplify and improve the efficiency of future actions to the extent possible and would not have any direct impacts on the environment or human communities as is primarily procedural in nature. As previously stated, under alternative 3b, the Council and Board could still decide it is more appropriate to use an amendment if significant changes are proposed. The impacts of any specific changes to the commercial/ recreational allocations or transfers between the sectors considered through a future framework/ addendum would be analyzed through a separate process with associated public comment opportunities and a full description of expected impacts.

## **4.5 ALTERNATIVE STATE MANAGEMENT REGIMES**

### **4.5.1 General Procedures**

A state may submit a proposal for a change to its regulatory program or any mandatory compliance measure under this Amendment to the Commission. Such changes shall be submitted to the Chair of the Plan Review Team (PRT), who shall distribute the proposal to appropriate groups, including the Board, the PRT, the TC, and the AP.

The PRT is responsible for gathering the comments of the TC and the AP. The PRT is also responsible for presenting these comments to the Board for decision.

The Board will decide whether to approve the state proposal for an alternative management program if it determines that it is consistent with the target fishing mortality rate applicable as well as the goals and objectives of this Amendment.

In order to maintain consistency within a fishing season, new rules should be implemented prior to the start of the fishing season. Given the time needed for the TC, AP, and Board to review the proposed regulations, as well as the time required by an individual state to promulgate new regulations, it may not be possible to implement new regulations for the on-going fishing season. In this case, new regulations should be effective at the start of the following season after a determination to do so has been made.

### **4.5.2 Management Program Equivalency**

The technical committee, under the direction of the PRT, will review any alternative state proposals under this section and provide its evaluation of the adequacy of such proposals to the Board via the PRT. The PRT can also ask for reviews by the Law Enforcement Committee (LEC) or the AP.

### **4.5.3 De minimis Fishery Guidelines**

The Commission's Interstate Fisheries Management Program Charter defines *de minimis* as a situation in which, under existing conditions of the stock and scope of the fishery, conservation and enforcement actions taken by an individual state would be expected to contribute insignificantly to a coastwide conservation program required by an FMP or amendment. Commission FMPs commonly include *de minimis* provisions to relieve regulatory and monitoring burdens for states that meet predetermined conditions and follow a defined request process.

*De minimis* status currently is only applicable to the summer flounder FMP, and is not applicable to scup or black sea bass. Any state in which commercial summer flounder landings during the last preceding calendar year for which data are available were less than 0.1 percent of the total coastwide quota for that year could be granted *de minimis* status for the summer flounder commercial fishery by NOAA Fisheries and Commission upon the annual recommendation of the Council and Commission, by way of a formal written request from the

state and subsequent review and recommendation of the Summer Flounder Monitoring Committee. The following conditions would apply:

- (1) The *de minimis* status will be valid only for that year for which the specifications are in effect, and will be effective upon filing by the NOAA Fisheries of the final specifications for the commercial summer flounder fishery with the Office of the Federal Register.
- (2) The total quota allocated to each *de minimis* state will be set equal to 0.1 percent of the total yearly allocation, and will be subtracted from the coastwide quota before the remainder is allocated to the other states.
- (3) In applying for *de minimis* status, a state must show that it has implemented reasonable steps to prevent landings from exceeding its *de minimis* allocation.

## **4.6 ADAPTIVE MANAGEMENT**

The Board may vary the requirements specified in this Amendment as a part of adaptive management in order to conserve the summer flounder, scup, and black sea bass resources. The elements that can be modified by adaptive management are listed in *Section 4.6.2*. The process under which adaptive management can occur is provided below.

### **4.6.1 General Procedures**

The PRT will monitor the status of the fishery and the resource and report on that status to the Board annually or when directed to do so by the Board. The PRT will consult with TC, the SASC, and the AP in making such review and report, if necessary.

The Board will review the report of the PRT, and may consult further with the TC, or AP. The Board may, based on the PRT report or on its own discretion, direct the plan development team (PDT) to prepare an addendum to make any changes it deems necessary. The addendum shall contain a schedule for the states to implement the new provisions.

The PDT will prepare a draft addendum as directed by the Board, and shall distribute it to all states for review and comment. A public hearing will be held in any state that requests one. The PDT will also request comment from federal agencies and the public at large. After at least a 30-day review period, staff, in consultation with the PDT, will summarize the comments received and prepare a final version of the addendum for the Board.

The Board shall review the final version of the addendum prepared by the PDT, and shall also consider the public comments received and the recommendations of the TC, LEC, and AP. The Board shall then decide whether to adopt, or revise and then adopt, the addendum. Upon adoption of an addendum by the Board, states shall prepare plans to carry out the addendum, and submit them to the Board for approval according to the schedule contained in the addendum.

#### **4.6.2 Measures Subject to Change**

The following measures are subject to change under adaptive management upon approval by the Board:

- (1.) Minimum fish size.
- (2.) Maximum fish size.
- (3.) Gear restrictions.
- (4.) Gear requirements or prohibitions.
- (5.) Permitting restrictions.
- (6.) Recreational possession limit.
- (7.) Recreational seasons.
- (8.) Closed areas.
- (9.) Commercial seasons.
- (10.) Commercial trip limits.
- (11.) Commercial quota system including commercial quota allocation procedure and possible quota set asides to mitigate bycatch.
- (12.) Recreational harvest limit.
- (13.) Annual specification quota setting process.
- (14.) FMP Technical Monitoring Committee composition and process
- (15.) Description and identification of essential fish habitat (EFH) and fishing gear management measures that impact EFH.
- (16.) Description and identification of habitat areas of particular concern.
- (17.) Overfishing definition and related thresholds and targets.
- (18.) Regional gear restrictions.
- (19.) Regional season restrictions (including option to split seasons).
- (20.) Restrictions on vessel size (LOA and GRT) or shaft horsepower.
- (21.) Operator permits
- (22.) Any other commercial or recreational management measure
- (23.) Any other management measures currently included in the FMP.
- (24.) Set aside quotas for scientific research.
- (25.) Commercial/recreational sector allocations
- (26.) Commercial/recreational sector transfers.

#### **4.6.3 Proposed Adaptive Management Measures**

This alternative set would add certain issues considered through this Amendment to the list of measures subject to change under adaptive management. Under this action, the adaptive management measures would apply to commercial/recreational allocation changes and quota transfer provisions between the commercial and recreational sectors.

##### ***Alternative 4a: No action/status quo***

This alternative makes no changes to the list of measures subject to change. Future changes to commercial/recreational allocations must be made through an amendment.

***Alternative 4b: Allow changes to commercial/recreational allocations***

This alternative adds annual quota transfers, and commercial/recreational allocations to the list of measures subject to change through adaptive management.

**4.7 EMERGENCY PROCEDURES**

Emergency procedures may be used by the Board to require any emergency action that is not covered by, is an exception to, or a change to any provision in this Amendment. Procedures for implementation are addressed in the ASMFC Interstate Fisheries Management Program Charter, Section Six (c)(10) (ASMFC 2019).

**4.8 MANAGEMENT INSTITUTIONS**

**4.8.1 Atlantic States Marine Fisheries Commission and ISFMP Policy Board**

The Commission and the ISFMP Policy Board are generally responsible for the oversight and management of the Commission's fisheries management activities. The Commission must approve all fishery management plans and amendments, including this Amendment. The ISFMP Policy Board reviews any non-compliance recommendations of the various Boards and, if it concurs, forwards them to the Commission for action.

**4.8.2 Summer Flounder, Scup, and Black Sea Bass Management Board**

The Board was established under the provisions of the Commission's ISFMP Charter (Section Four; ASMFC 2019) and is generally responsible for carrying out all activities under this Amendment.

The Board establishes and oversees the activities of the Plan Development Team, Plan Review Team, Technical Committee, and the Advisory Panel. In addition, the Board makes changes to the management program under adaptive management, reviews state programs implementing the amendment, and approves alternative state programs through conservation equivalency. The Board reviews the status of state compliance with the management program annually, and if it determines that a state is out of compliance, reports that determination to the ISFMP Policy Board under the terms of the ISFMP Charter.

**4.8.3. Summer Flounder, Scup, and Black Sea Bass Commercial/Recreational Allocation Amendment Fishery Management Action Team and Plan Development Team**

The Fishery Management Action Team (FMAT) and the Plan Development Team (PDT) is composed of personnel from state and federal agencies who have scientific knowledge of summer flounder, scup, and black sea bass and management abilities. The FMAT/PDT is responsible for preparing and developing management documents, including amendments, using the best scientific information available and the most current stock assessment information. FMAT and PDT membership and purpose are identical, the key distinction is the FMAT is convened in accordance with MAFMC guidelines and the PDT is convened in accordance with the Interstate Fisheries Management Program Charter. For ease of reading,

the PDT/FMAT is simply referred to as FMAT throughout this Amendment. The ASMFC FMP Coordinators are members of the FMAT/PDT. The FMAT/PDT will either disband or assume inactive status upon completion of this Amendment.

#### **4.8.4 Summer Flounder, Scup, and Black Sea Bass Commercial/Recreational Allocation Amendment Plan Review Team**

The Plan Review Team (PRT) is composed of personnel from state and federal agencies who have scientific and management ability and knowledge of summer flounder, scup, and black sea bass. The PRT is responsible for providing annual advice concerning the implementation, review, monitoring, and enforcement of this Amendment once it has been adopted by the Commission. After final action on the amendment, the Board may elect to retain members of the PDT as members of the PRT, or appoint new members.

#### **4.8.5 Summer Flounder, Scup, and Black Sea Bass Technical Committee**

The Summer Flounder, Scup, and Black Sea Bass Technical Committee (TC) consists of representatives from state or federal agencies, Regional Fishery Management Councils, the Commission, a university, or other specialized personnel with scientific and technical expertise, and knowledge of the summer flounder, scup, and black sea bass fisheries. The Board appoints the members of the TC and may authorize additional seats as it sees fit. The role of the TC is to assess the species' population, provide scientific advice concerning the implications of proposed or potential management alternatives, and respond to other scientific questions from the Board, PDT, or PRT.

#### **4.8.6 Summer Flounder, Scup, and Black Sea Bass Advisory Panel**

The Summer Flounder, Scup, and Black Sea Bass Advisory Panel (AP) is established according to the Commission's Advisory Committee Charter. Members of the AP are citizens who represent a cross-section of commercial and recreational fishing interests and others who are concerned about summer flounder, scup, and black sea bass conservation and management. The AP provides the Board with advice directly concerning the Commission's summer flounder, scup, and black sea bass management program.

#### **4.8.7 Federal Agencies**

##### ***4.8.7.1 Management in the Exclusive Economic Zone***

Management of summer flounder in the EEZ is within the jurisdiction of one Regional Fishery Management Council (the Mid-Atlantic Fishery Management Council) under the Magnuson-Stevens Act (16 U.S.C. 1801 et seq.). The Council annually makes recommendations on catch and landings limits as well as gear modifications to the NOAA Fisheries through the specification process. More information can be found in section 4.1.

##### ***4.8.7.2 Federal Agency Participation in the Management Process***

The Commission has accorded USFWS and NOAA Fisheries voting status on the ISFMP Policy Board and the Summer Flounder, Scup, and Black Sea Bass Management Board in accordance with the Commission's ISFMP Charter. NOAA Fisheries can also participate on the Summer Flounder, Scup, and Black Sea Bass FMAT, PRT, and TC.

#### **4.8.7.3 Consultation with Fishery Management Councils**

At the time of adoption of this Amendment, the Mid-Atlantic Fishery Management Council is the only Regional Fishery Management Council to have implemented a management plan for summer flounder, scup, and black sea bass; no other Councils have indicated an intent to develop a plan.

### **4.9 RECOMMENDATIONS TO THE SECRETARY OF COMMERCE FOR COMPLEMENTARY ACTIONS IN FEDERAL JURISDICTIONS**

The summer flounder, scup, and black sea bass fishery management plan is jointly managed between the Commission, Council, and NOAA Fisheries. The proposed alternatives in this Amendment will affect both state and federal permit holders operating in the commercial and recreational summer flounder, scup, and black sea bass fisheries in both state and federal waters. The Atlantic states (through the Commission), the Council, and NOAA Fisheries through joint management coordinate to ensure consistency in management between state and federal waters. Therefore, a specific recommendation to the Secretary of Commerce for complementary action in federal jurisdictions is unnecessary at this time. The Board may consider further recommendations to the Secretary if changes to this Amendment occur through the adaptive management process (*Section 4.6*).

### **4.10 COOPERATION WITH OTHER MANAGEMENT INSTITUTIONS**

The Board will cooperate, when necessary, with other management institutions during the implementation of this Amendment, including NOAA Fisheries and the New England, Mid-Atlantic, and South Atlantic Fishery Management Council.

## **5.0 COMPLIANCE**

The full implementation of the provisions included in this Amendment is necessary for the management program to be equitable, efficient, and effective. States are expected to implement these measures faithfully under state laws. The Commission will continually monitor the effectiveness of state implementation and determine whether states are in compliance with the provisions of this fishery management plan.

The Board sets forth specific elements that the Commission will consider in determining state compliance with this fishery management plan, and the procedures that will govern the evaluation of compliance. Additional details of the procedures are found in the ASMFC Interstate Fishery Management Program Charter (ASMFC 2019).

### **5.1 MANDATORY COMPLIANCE ELEMENTS FOR STATES**

A state will be determined to be out of compliance with the provision of this fishery management plan according to the terms of Section Seven of the ISFMP Charter if:

- Its regulatory and management programs to implement this Amendment have not been approved by the Board; or



## DRAFT AMENDMENT FOR PUBLIC COMMENT

- It fails to meet any schedule required by Section 5.2, or any addendum prepared under adaptive management (*Section 4.6*); or
- It has failed to implement a change to its program when determined necessary by the Board; or
- It makes a change to its regulations required under *Section 4* or any addendum prepared under adaptive management (*Section 4.6*), without prior approval of the Board.

### **5.1.1 Regulatory Requirements**

To be considered in compliance with this fishery management plan, all state programs must include a regime of restrictions on summer flounder, scup, and black sea bass fisheries consistent with the requirements of *Section 3.1.1: Commercial Catch and Landings Programs*; *Section 3.3: Biological Data Collection Programs*; and *Section 4.0: Management Program*. A state may propose an alternative management program under *Section 4.5: Alternative State Management Regimes*, which, if approved by the Board, may be implemented as an alternative regulatory requirement for compliance. This document complements other regulatory requirements and standards pertaining to summer flounder, scup, and black sea bass fisheries. The recreational management measures specifications process for summer flounder and black sea bass (Addendum XXXII), scup commercial quota management (Addendum XXIX), etc. Each species' key compliance items requested through the annual compliance review are listed below in section 5.3.

## **5.2 COMPLIANCE SCHEDULE**

States must implement this Amendment according to the following schedule:

- |                  |   |
|------------------|---|
| Month Day, 202X: | Submission of state plans to implement the amendment for approval by the Board, if it is necessary to change state law or regulation.             |
| Month Day, 202X: | Implementation date of the Amendment. This date may change based on the timing of Final Approval of the Council FMP by the Secretary of Commerce. |

### 5.3 COMPLIANCE REPORT CONTENT

#### 5.3.1 Summer Flounder Compliance Report Content

Each state must submit to the Commission an annual report concerning its summer flounder fisheries and management program for the previous year, no later than June 1st. A standard compliance report format has been prepared and adopted by the ISFMP Policy Board. States should follow this format in completing the annual compliance report.

The report shall cover:

#### **Request for *de minimis*, where applicable.**

Any state that has commercial landings of less than 0.1% of the total coastwide commercial landings in the last preceding year for which data are available is eligible for *de minimis* status.

#### **Previous calendar year's fishery**

- a. Activities of fishery dependent monitoring (provide a brief review of results including monitoring of gear restrictions; prohibition of transfers at sea; and minimum size limit).
- b. Activities of fishery independent monitoring (provide a brief review of results).
- c. Copy of regulations that were in effect for 2019. Has the state implemented the required measures as mandated in the FMP, listed below? Please answer with either 'yes' or 'no'.

#### **Commercial**

Has the state implemented the required measure?	yes	no
14" minimum size		
5.5" diamond or 6" square minimum mesh		
Threshold to trigger minimum mesh size requirements: (200 lbs 11/1 - 4/30; 100 lbs from 5/1 - 10/31)		
Prohibition of transfers at sea		

#### **Recreational**

Provide state specific measures for the previous and current fishing season.

- d. Harvest broken down by commercial (by gear type where applicable) and recreational, and non-harvest losses (when available).

#### **Planned management programs for the current calendar year**

Summarize any changes from previous years

### 5.3.2 Scup Compliance Report Content

Each state must submit to the Commission an annual report concerning its scup fisheries and management program for the previous year, no later than June 1st. A standard compliance report format has been prepared and adopted by the ISFMP Policy Board. States should follow this format in completing the annual compliance report.

#### Request for *de minimis*, where applicable.

Any state that has commercial landings of less than 0.1% of the total coastwide commercial landings in the last preceding year for which data are available is eligible for *de minimis* status.

#### Previous calendar year's fishery

- a. Activities of fishery dependent monitoring (provide a brief review of results including monitoring of gear restrictions and quota management for the winter I & II and summer periods; minimum size).
- b. Activities of fishery independent monitoring (provide a brief review of results).
- c. Copy of regulations that were in effect for the most recent year. Has the state implemented the required measures as mandated in the FMP, listed below? Please answer with either 'yes' or 'no'.

#### Commercial

Has the state implemented the required measure?	yes	no
9" minimum size		
Minimum diamond mesh: Otter trawls must have a minimum mesh size of 5" for the first 75 meshes from the terminus of the net and a minimum mesh size of 5" throughout the net for codends constructed with fewer than 75 meshes		
Maximum roller rig trawl roller diameter: 18"		
Threshold to trigger minimum mesh requirements: (1,000 lbs 10/1 - 4/15; 2,000 lbs from 4/15 - 6/15; 200 lbs 6/15 - 9/30)		
Pot and trap escape vents: 3.1" circular escape vents, 2.25" square escape vent, or rectangular escape vent of equivalent size.		
Pot and trap degradable fastener provisions: a) untreated hemp, jute, or cotton string 3/16" (4.8 mm) or smaller; b) magnesium alloy timed float releases or fasteners; c) ungalvanized, uncoated iron wire of 0.094" (2.4mm) or smaller		

#### Recreational

Provide state specific measures for the previous and current fishing season

- d. Harvest broken down by commercial (by gear type where applicable) and recreational, and non-harvest losses (when available).

#### Planned management programs for the current calendar year

Summarize any changes from previous years.

### 5.3.3 Black Sea Bass Compliance Report Content

Each state must submit to the Commission an annual report concerning its summer flounder fisheries and management program for the previous year, no later than June 1st. A standard compliance report format has been prepared and adopted by the ISFMP Policy Board. States should follow this format in completing the annual compliance report.

#### Request for *de minimis*, where applicable.

Any state that has commercial landings of less than 0.1% of the total coastwide commercial landings in the last preceding year for which data are available is eligible for *de minimis* status. (Amendment 13)

#### Previous calendar year's fishery

- a. Activities of fishery dependent monitoring (provide a brief review of results including monitoring of gear restrictions and minimum size).
- b. Activities of fishery independent monitoring (provide a brief review of results).
- c. Copy of regulations that were in effect for 2019. Has the state implemented the required measures as mandated in the FMP, listed below? Please answer with either 'yes' or 'no'.

#### Commercial

Has the state implemented the required measure?	yes	no
11" minimum size		
4.5" minimum mesh size for entire net or 4.5" diamond mesh in codend (for large trawl nets)		
Threshold to trigger minimum mesh requirements: (500 lbs for January - March; 100 lbs from April- December)		
2.5" circular escape vents, 2" square escape vent, or 1.375" X 5.75" rectangular escape vent for pots/traps. Two vents required in parlor portion of pot/trap.		
Pot and trap degradable fastener provisions: a) untreated hemp, jute, or cotton string 3/16" (4.8 mm) or smaller; b) magnesium alloy timed float releases or fasteners; c) ungalvanized, uncoated iron wire of 0.094" (2.4mm) or smaller. The opening covered by a panel affixed with degradable fasteners would be required to be at least 3"x 6".		

#### Recreational

Provide state specific measures for the previous and current fishing season.

- d. Harvest broken down by commercial (by gear type where applicable) and recreational, and non-harvest losses (when available).

#### Planned management programs for the current calendar year

Summarize any changes from previous years.

#### **5.4 PROCEDURES FOR DETERMINING COMPLIANCE**

Detailed procedures regarding compliance determinations are contained in the ISFMP Charter, Section Seven (ASMFC 2019). In brief, all states are responsible for the full and effective implementation and enforcement of fishery management plans in areas subject to their jurisdiction. Written compliance reports as specified in the amendment must be submitted annually by each state with a declared interest. Compliance with this FMP will be reviewed at least annually; however, the Board, ISFMP Policy Board, or the Commission may request the PRT to conduct a review of state's implementation and compliance with the FMP at any time.

The Board will review the written findings of the PRT within 60 days of receipt of a State's compliance report. Should the Board recommend to the Policy Board that a state be determined out of compliance, a rationale for the recommended noncompliance finding will be addressed in a report. The report will include the required measures of this FMP that the state has not implemented or enforced, a statement of how failure to implement or enforce required measures jeopardizes the species in question's conservation, and the actions a state must take in order to comply with requirements of this FMP.

The ISFMP Policy Board will review any recommendation of noncompliance from the Board within 30 days. If it concurs with the recommendation, it shall recommend to the Commission that a state be found out of compliance.

The Commission shall consider any noncompliance recommendation from the ISFMP Policy Board within 30 days. Any state that is the subject of a recommendation for a noncompliance finding is given an opportunity to present written and/or oral testimony concerning whether it should be found out of compliance. If the Commission agrees with the recommendation of the ISFMP Policy Board, it may determine that a state is not in compliance with this Amendment, and specify the actions the state must take to come into compliance.

Any state that has been determined to be out of compliance may request that the Commission rescind its noncompliance findings, provided the state has revised its conservation measures.

#### **5.5 ANALYSIS OF ENFORCEABILITY OF PROPOSED MEASURES**

All state programs must include law enforcement capabilities adequate for successfully implementing that state's summer flounder, scup, and black sea bass regulations. The LEC will monitor the adequacy of a state's enforcement activity.

#### **6.0 MANAGEMENT AND RESEARCH NEEDS**

The following lists of research needs have been identified to enhance knowledge of the summer flounder, scup, and black sea bass resources. These research needs are drawn from the most recent benchmark stock assessments for each species; the MAFMC's Five Year Research

Plan (2020-2024); and the Commission's Research Priorities and Recommendations to Support Interjurisdictional Fisheries Management. The list of research recommendations are classified into 1) stock assessment and population dynamics; 2) research and data needs.

## **6.1 SUMMER FLOUNDER MANAGEMENT AND RESEARCH NEEDS**

### **6.1.1 Stock Assessment and Population Dynamics**

1. Continue to explore changes in the distribution of recruitment. Develop studies, sampling programs, or analyses to better understand how and why these changes are occurring, and the implications to stock productivity.
2. Evaluate the size distribution of landed and discarded fish, by sex, in the summer flounder fisheries.
3. Explore the potential mechanisms for recent slower growth that is observed in both sexes.
4. Incorporate sex -specific differences in size at age into the stock assessment.
5. Continue efforts to improve understanding of sexually dimorphic mortality and growth patterns. This should include monitoring sex ratios and associated biological information in the fisheries and all ongoing surveys to allow development of sex-structured models in the future.
6. Apply standardization techniques to all of the state and academic-run surveys, to be evaluated for potential inclusion in the assessment.

### **6.1.2 Research and Data Needs**

1. Collect data to evaluate the length, weight, and age compositions of landed and discarded fish in the summer flounder fisheries (recreational and commercial) by sex. Focus should be placed on age sampling of summer flounder 24 inches or larger in total length, using paired hard part samples (i.e., scales, and when possible, otoliths).
2. Evaluate Summer Flounder discard survival under different environmental variables and gear configurations with survey design considerations that account for to feeding and predation.
3. Continue to evaluate the causes for decreased recruitment, changes in recruitment distribution, and changes in the recruit-per-spawner relationship in recent years. Develop studies, sampling programs, or analyses to better understand how and why these changes are occurring, and the implications to stock productivity.
4. Evaluate changes in habitat use/availability by early life stage summer flounder.

## **6.2 SCUP MANAGEMENT AND RESEARCH NEEDS**

### **6.2.1 Stock Assessment and Population Dynamics**

1. A standardized fishery dependent CPUE of scup targeted tows, from either Northeast Fisheries Observer Program observer samples or the commercial study fleet, might be considered as an additional index of abundance to complement survey indices in future benchmark assessments.
2. Explore additional sources of length/age data from fisheries and surveys in the early parts of the time series to provide additional context for model results.
3. Explore experiments to estimate catchability of scup in NEFSC and other research trawl surveys (side-by-side, camera, gear mensuration, acoustics, etc.)
4. Quantification of the biases in the catch and discards, including non-compliance, would help confirm the weightings used in the next stock assessment model.
5. Experimental work to better characterize the discard mortality rate of scup captured by different commercial gear types should be conducted to more accurately quantify the magnitude of scup discard mortality.
6. A scientifically designed survey to sample larger and older scup would likely prove useful in improving knowledge of the relative abundance of these larger fish.
7. Explore the applicability of the pattern of fishery selectivity in the model to the most recent catch data to determine whether a new selectivity block in the model is warranted.

### **6.2.2 Research and Data Needs**

1. A management strategy evaluation of alternative approaches to setting quota.
2. Evaluate the spatial and temporal overlap of Scup and squid to better understand and characterize Scup discard patterns.
3. Characterize the pattern of selectivity for older ages of scup in both surveys and fisheries.
4. Explore the relationship between Scup market trends, regulatory changes, and commercial landings and discards.
5. Evaluate the role and relative importance of implemented strategies (i.e., gear restricted areas, increased minimum mesh size, and minimizing scup and squid fishery interactions) versus the long-term climate variability to the increases in stock abundance and high recruitment events since 2000.

6. Characterize the current Scup market and explore the development of new markets.

### **6.3 BLACK SEA BASS MANAGEMENT AND RESEARCH NEEDS**

#### **6.3.1 Stock Assessment and Population Dynamics**

1. Continue and expand the tagging program to provide increased age information and increased resolution on mixing rates among putative populations
2. Expand on previous genetic studies with smaller spatial increments in sampling.
3. Consider the impact of climate change on black sea bass, particularly in the Gulf of Maine.
4. Evaluate population sex change and sex ratio, particularly comparing dynamics among communities.
5. Study black sea bass catchability in a variety of survey gear types.
6. Investigate and document social and spawning dynamics of black sea bass.
7. Evaluate use of samples collected by industry study fleets.
8. Explore alternative assessment models, including non-age based alternatives

#### **6.3.2 Research and Data Needs**

1. Increase sampling of commercial landings
2. Increase sample size of at sea observers and dockside validation of headboats. Increase recreational fisheries sampling.
3. Determine depth, temperature, and season specific discard mortality rates. Assess and incorporate the impact of circle hook fishing regulations on discard mortality. Obtain more depth specific information from the private recreational fleet, MRIP At-Sea observer program, and Headboat Survey in the range of the southern stock.
4. Collect better spatial information in black sea bass fisheries to determine potential localized depletion effects.
5. Conduct a pot survey throughout the range of the northern management unit and consider for an index of abundance.
6. Expand fishery-independent surveys to sample all sizes and age classes to develop more reliable catch-at-age and CPUE.



DRAFT AMENDMENT FOR PUBLIC COMMENT

7. Expand sampling to cover the entire range of the southern stock over a longer time period.
8. Conduct at sea sex sampling to determine trend of sex change timing and assess the potential influence of population size on sex switching.
9. Develop a reliable fishery independent index for black sea bass for habitats not effectively sampled with existing methodologies.

## 7.0 REFERENCES

- Able, K.W. and M.P. Fahay. 2010. Pp. 354-358 in: Ecology of Estuarine Fishes: Temperate Waters of the Western North Atlantic. Johns Hopkins Press.
- Able, K.W. and L.S. Hales, Jr. 1997. Movements of juvenile black sea bass *Centropristis striata* (Linnaeus) in a southern New Jersey estuary. *J. Exp. Mar. Biol. Ecol.* 213: 153-167.
- Adams, A.J. 1993. Dynamics of fish assemblages associated with an offshore artificial reef in the southern Mid-Atlantic Bight. M.A. thesis, Coll. William and Mary, Williamsburg, VA. 98 p.
- Allen, D.M., J.P. Clymer, III, and S.S. Herman. 1978. Fishes of Hereford Inlet estuary, southern New Jersey. Lehigh Univ., Dept. Biol. and Cent. Mar. Environ. Stud. and Wetlands Instit. 138 p.
- ASMFC (Atlantic States Marine Fisheries Commission). 2016. 2016 Tautog Stock Assessment Update. Available at: [http://www.asmfc.org/uploads/file/589e1d3f2016TautogAssessmentUpdate\\_Oct2016.pdf](http://www.asmfc.org/uploads/file/589e1d3f2016TautogAssessmentUpdate_Oct2016.pdf).
- ASMFC (Atlantic States Marine Fisheries Commission). 2017. 2017 Atlantic Croaker Stock Assessment Peer Review. Available at: [http://www.asmfc.org/uploads/file/59c2ba88AtlCroakerAssessmentPeerReviewReport\\_May2017.pdf](http://www.asmfc.org/uploads/file/59c2ba88AtlCroakerAssessmentPeerReviewReport_May2017.pdf).
- Auster, P.J., R.J. Malatesta, and S.C. LaRosa. 1995. Patterns of microhabitat utilization by mobile megafauna on the southern New England (USA) continental shelf and slope. *Mar. Ecol. Prog. Ser.* 127: 77-85.
- Auster, P.J., R.J. Malatesta, S.C. LaRosa, R.A. Cooper, and L.L. Stewart. 1991. Microhabitat utilization by the megafaunal assemblage at a low relief outer continental shelf site - Middle Atlantic Bight, USA. *J. Northwest Atl. Fish. Sci.* 11: 59-69.
- Bell, R.J. et al. 2015. Disentangling the effects of climate, abundance, and size on the distribution of marine fish: an example based on four stocks from the Northeast US shelf. *ICES J. Mar. Sci.* 72(5):1311-1322.
- Blaylock, J. and G.R. Shepherd. 2016. Evaluating the vulnerability of an atypical protogynous hermaphrodite to fishery exploitation: results from a population model for black sea bass (*Centropristis striata*). *Fishery Bulletin* 114(4): 476-489.
- Bigelow, H.B. and W.C. Schroeder. 1953. Fishes of the Gulf of Maine. U.S. Fish Wildl. Serv. Fish. Bull. 53. 577 p.
- Briggs, P.T. 1975. An evaluation of artificial reefs in New York's marine waters. *N.Y. Fish Game J.* 22: 51-56.
- Clayton, G., C. Cole, S. Murawski, and J. Parrish. 1978. Common marine fishes of coastal Massachusetts. *Contrib. 54, Mass. Coop. Fish. Res. Prog. Univ. Mass., Amherst.* 231 p.
- Drohan, A.F., J. P. Manderson, D. B. Packer. 2007. Essential fish habitat source document: black sea bass, *Centropristis striata*, life history and habitat characteristics, 2nd edition. NOAA Technical Memorandum NOAA Fisheries NE 200; 68 p.

DRAFT AMENDMENT FOR PUBLIC COMMENT

- Eklund, A.-M. 1988. Fishes inhabiting hard bottom reef areas in the Middle Atlantic Bight: seasonality of species composition, catch rates, and reproduction. M.S. thesis, Univ. of Delaware, Newark, DE. 98 p.
- Eno, N.C., D.S MacDonald, J.A.M. Kinnear, S.C Amos, C.J. Chapman, R.A Clark, F.P.D Bunker, Munro, C. 2001. Effects of crustacean traps on benthic fauna. *ICES Journal of Marine Science*. 58:11-20.
- Finkelstein, S.L. 1969. Age and growth of scup in the waters of eastern Long Island. N.Y. Fish Game J. 16: 84-110.
- Gaichas, S., J. Hare, M. Pinsky, G. DePiper, O. Jensen, T. Lederhouse, J. Link, D. Lipton, R. Seagraves, J. Manderson, and M. Clark. 2015. Climate change and variability: a white paper to inform the Mid-Atlantic Fishery Management Council on the impact of climate change on fishery science and management. Second draft. Available at: <http://www.mafmc.org/eafm/>
- Gilbert, CR and JD Williams. 2002. National Audubon Society Field Guide to Fishes: North America. Alfred A. Knopf, New York, NY.
- Gottschall, K., M.W. Johnson, and D.G. Simpson. 2000. The distribution and size composition of finfish, American lobster and long-finned squid in Long Island Sound, based on the Connecticut Fisheries Division bottom trawl survey, 1984-1994. NOAA Tech. Rep. NOAA Fisheries 148, 195 p.
- Gray, C.L. 1990. Scup (*Stenotomus chrysops*): species profile. Rhode Island Dep. Environ. Manag., Div. Fish. Wildl., Mar. Fish. Sect. 38 p.
- Greene, J.K., M.G. Anderson, J. Odell, and N. Steinberg, eds. 2010. The Northwest Atlantic Marine Ecoregional Assessment: Species, Habitats and Ecosystems. Phase One. The Nature Conservancy, Eastern U.S. Division, Boston, MA. Available at: [www.conservationgateway.org](http://www.conservationgateway.org)
- Kendall, A.W. 1973. Scup. In A.L. Pacheco ed. Proceedings of a workshop on egg, larval and juvenile stages of fish in Atlantic coast estuaries. p. 258. U.S. Dep. Commer. NOAA, NOAA Fisheries Mid-Atl. Coastal Fish. Cent. Tech. Publ. No. 1.
- Lucey, S. M. and J. A. Nye. 2010. Shifting species assemblages in the northeast US continental shelf large marine ecosystem. *Marine Ecology Progress Series*. 415: 23-33.
- MAFMC (Mid-Atlantic Fishery Management Council). 1996. Amendment 8 to the summer flounder Fishery Management Plan: Fishery Management Plan and final environmental impact statement for the scup fishery. January 1996. MAFMC. [Dover, DE.] 162 p. + appendices.
- MAFMC (Mid-Atlantic Fishery Management Council). 1998. Amendment 12 to the Summer Flounder, Scup, and Black Sea Bass Fishery Management Plan. Dover, DE. 398 p. + appendices. Available at: [http://www.mafmc.org/s/SFSCBSB\\_Amend\\_12.pdf](http://www.mafmc.org/s/SFSCBSB_Amend_12.pdf).
- MAFMC (Mid-Atlantic Fishery Management Council). 2002. Amendment 13 to the Summer Flounder, Scup, and Black Sea Bass Fishery Management Plan. Dover, DE. Available at: [https://mafmc.squarespace.com/s/SFSCBSB\\_Amend\\_13\\_Vol\\_1compressed.pdf](https://mafmc.squarespace.com/s/SFSCBSB_Amend_13_Vol_1compressed.pdf)

DRAFT AMENDMENT FOR PUBLIC COMMENT

- MAFMC (Mid-Atlantic Fishery Management Council). 2008. Amendment 9 to the Atlantic Mackerel, Squid, and Butterfish Fishery Management Plan. 461 p. Available at: [http://www.mafmc.org/s/SMB\\_Amend\\_9\\_Vol\\_1.pdf](http://www.mafmc.org/s/SMB_Amend_9_Vol_1.pdf).
- MAFMC (Mid-Atlantic Fishery Management Council). 2019. Comprehensive Five-Year (2020-2024) Research Priorities, December 2019. 17 p. Available at: <https://www.mafmc.org/research-priorities>.
- Morgan, L.E., and R. Chuenpagdee. 2003. Shifting gears: addressing the collateral impacts of fishing methods in U.S. waters. Pew science series on conservation and the environment.
- Morse, W.W. 1978. Biological and fisheries data on scup, *Stenotomus chrysops* (Linnaeus). U.S. Natl. Mar. Fish. Serv. Northeast Fish. Cent. Sandy Hook Lab. Tech. Rep. No. 12. 41 p.
- NEFMC (New England Fishery Management Council). 2018. Framework Adjustment 5 to the Northeast Skate Complex FMP. Newburyport, MA.
- NEFSC (Northeast Fisheries Science Center). 2015. 60<sup>th</sup> Northeast Regional Stock Assessment (60<sup>th</sup> SAW) assessment report. Northeast Fisheries Science Center Reference Document 15-08; 870 p.
- NEFSC (Northeast Fisheries Science Center). 2017. 62nd Northeast Regional Stock Assessment Workshop (62nd SAW) Assessment Report. US Dept Commer, Northeast Fish Sci Cent Ref Doc. 17-03; 822 p. Available from: National Marine Fisheries Service, 166 Water Street, Woods Hole, MA 02543-1026, or online at <http://nefsc.noaa.gov/publications/>.
- NEFSC (Northeast Fisheries Science Center). 2018. Update on the Status of Spiny Dogfish in 2018 and Projected Harvests at the Fmsy Proxy and Pstar of 40%. Report to the Mid-Atlantic Scientific and Statistical Committee. 82 p. Available at: <http://www.mafmc.org/s/2018-Status-Report-for-spiny-dogfish.pdf>
- NEFSC (Northeast Fisheries Science Center). 2019a. 66th Northeast Regional Stock Assessment Workshop (66th SAW) Assessment Report. US Dept Commer, Northeast Fish Sci Cent Ref Doc. 19-08; 1170 p. Available from: National Marine Fisheries Service, 166 Water Street, Woods Hole, MA 02543-1026, or online at <http://nefsc.noaa.gov/publications/>.
- NEFSC (Northeast Fisheries Science Center). 2019b. Operational Assessment of the Black Sea Bass, Scup, Bluefish, and Monkfish Stocks, Updated Through 2018. Prepublication copy prepared for use by Fishery Management Council staff and SSC. 164 p. Available at: [http://www.mafmc.org/s/Operational-Assessments-for-Black-Sea-Bass\\_Scup\\_Bluefish.pdf](http://www.mafmc.org/s/Operational-Assessments-for-Black-Sea-Bass_Scup_Bluefish.pdf).
- Nye, J. A., T. M. Joyce, Y.O. Kwon, and J.S. Link. 2011. Silver hake tracks changes in Northwest Atlantic circulation. *Nature Communications*. 2:412.
- Packer, David; Griesbach, Sara; Berrien, Peter; Zetlin, Christine; Johnson, Donna; Morse, Wallace. 1999. "Essential Fish Habitat Source Document: Summer Flounder, *Paralichthys dentatus*, Life History and Habitat Characteristics." Highlands, NJ. Available at: <http://www.nefsc.noaa.gov/nefsc/publications/tm/tm151/tm151.pdf>.
- Parker, R.O., Jr. 1990. Tagging studies and diver observations of fish populations on live-bottom reefs of the U.S. southeastern coast. *Bull. Mar. Sci.* 46: 749-760.

DRAFT AMENDMENT FOR PUBLIC COMMENT

- Pinsky, M.L., B. Worm, M.J. Fogarty, J.L. Sarmiento, and S.A. Levin. 2013. Marine taxa track local climate velocities. *Science*. 341(6151): 1239-1242.
- Richards, S.W. 1959. Pelagic fish eggs and larvae of Long Island Sound. In G.A. Riley et al. eds. *Oceanography of Long Island Sound*. p. 95-124. Bull. Bingham Oceanogr. Collect. 17.
- Richards, S.W. 1963. The demersal fish population of Long Island Sound. III. Food of the juveniles from a mud locality (Station 3A). Bull. Bingham Oceanogr. Collect. 18: 73-93.
- SEDAR. 2015. SEDAR 39 Stock Assessment Report: HMS Atlantic smooth dogfish. North Charleston (SC): SEDAR.
- Sisson, R.T. 1974. The growth and movements of scup (*Stenotomus chrysops*) in Narragansett Bay, Rhode Island and along the Atlantic coast. Rhode Island Dep. Nat. Resources, Completion Rept. Project No. 3-138-R. 34 p.
- Steimle, F.W. and W. Figley. 1996. The importance of artificial reef epifauna to black sea bass diets in the Middle Atlantic Bight. *N. Am. J. Fish. Manage.* 16:433-439.
- Steimle, FW, Zetlin CA, Berrien PL, Johnson DL, Chang S. 1999. Essential fish habitat source document: Scup, *Stenotomus chrysops*, life history and habitat characteristics. NOAA Tech Memo NOAA Fisheries NE 149; 39 p.
- Steimle, FW, and Zetlin CA. 2000. Reef habitats in the middle Atlantic bight: abundance, distribution, associated biological communities, and fishery resource use. *Marine Fisheries Review*. 62: 24-42. 62: 24-42.
- Stevenson, D., L. Chiarella, D. Stephan, R. Reid, K. Wilhelm, J. McCarthy, M. Pentony. 2004. Characterization of the fishing practices and marine benthic ecosystems of the Northeast U.S. Shelf, and an evaluation of the potential effects of fishing on Essential Fish Habitat. NOAA Technical Memorandum NOAA Fisheries -NE-181; 179 p.
- Weinberg, J. R. 2005. Bathymetric shift in the distribution of Atlantic surfclams: response to warmer ocean temperature. *ICES Journal of Marine Science*. 62(7): 1444-1453.
- Wheatland, S.B. 1956. Pelagic fish eggs and larvae. In G.A. Riley et al. eds. *Oceanography of Long Island Sound, 1952-1954*. p. 234-314. Bull. Bingham Oceanogr. Collect. 15.

**APPENDIX I: SUPPLEMENTAL INFORMATION ON BASIS FOR ALLOCATION ALTERNATIVES**

This appendix describes the rationale behind each of the commercial/recreational allocation percentage alternatives listed in alternative sets 1a-1c (Table 39). These alternatives were initially developed by the FMAT (Fishery Management Action Team) and approved by the Council and Board for inclusion in this Amendment.

**Table 39. Alternatives considered through this Amendment for commercial/recreational allocation percentages (i.e., alternative sets 1a – summer flounder, 1b - scup, and 1c – black sea bass) grouped according to the approach used to derive the alternatives.**

<b>Approach</b>	<b>Description</b>	<b>Associated Alternatives</b>
A	No action/status quo	1a-4, 1b-1, 1c-4
B	Same base years as current allocations (varies by species) but with new data	1a-5, 1b-2, 1b-5*, 1c-5
C	2004-2018 base years	1a-1, 1a-6*, 1b-6, 1c-2
D	2009-2018 base years	1a-2*, 1a-6*, 1b-3*, 1b-5*, 1c-3, 1c-7*
E	2014-2018 base years	1a-3, 1a-7, 1b-5*, 1c-7*
F	Approximate status quo harvest per sector compared to 2017/2018 (summer flounder) or 2018/2019 (scup, black sea bass)	1a-2*, 1b-4, 1b-7, 1c-1, 1c-6*
G	Average of other approaches approved by Council/Board in June 2020	1a-2*, 1b-3*, 1c-6*

\*indicates an alternative supported by multiple approaches.

***Approach A (no action/status quo)***

The no action/status quo alternatives consider the consequences of taking no action and retaining the current commercial/recreational allocations. It is required that all Council and Commission amendments consider no action/status quo alternatives.

***Approach B (same base years as current allocations but with new data)***

This approach would use updated recreational and commercial data from the same base years as the current allocations to inform new allocation percentages. This is the basis (or, depending on the alternative, part of the basis) for alternatives 1a-5, 1b-2, 1b-5, and 1c-5.

Both catch and landings-based alternatives using this approach are considered for scup (alternatives 1b-2 and 1b-5, respectively). However, for summer flounder and black sea bass, only landings-based alternatives using this approach are considered (alternative 1a-5 for summer flounder and 1c-5 for black sea bass). This is because dead discard estimates in weight are not available for all the current base years for summer flounder (i.e., 1980-1989) and black sea bass (i.e., 1983-1992). Estimates of landings and dead discards in weight in both sectors are available for all the current base years for scup (i.e., 1988-1992).

MRIP does not provide estimates of recreational catch or harvest prior to 1981; therefore, the full 1980-1989 base years for summer flounder cannot be re-calculated for the recreational fishery. Instead, alternative 1a-5 uses 1981-1989 as the base years.

The rationale behind the selection of the current base years for each species is not explicitly defined in the FMP amendments that first implemented the commercial/recreational allocations. The current base years for scup and black sea bass are all years prior to Council and Commission management. For summer flounder, the Commission FMP was adopted in 1982 but contained mostly management guidelines rather than required provisions. The joint Council and Commission FMP was adopted in 1988, toward the end of the 1980-1989 base year period used to develop allocations. The management program for summer flounder was quite limited until Amendment 2 was implemented in 1993. The current base years for each species were likely chosen based on a desire to use as long of a pre-management time period as possible considering the limitations of the relevant data sets.

The approach of revising the commercial/recreational allocations using the same base years and new data allows for consideration of fishery characteristics in years prior to influence by the commercial/recreational allocations, while also using what is currently the best scientific information available to understand the fisheries in those base years.

***Approach III (2004-2018 base years), approach D (2009-2018 base years), and approach E (2014-2018 base years)***

Under approaches C, D, and E, the commercial/recreational allocation for each species would be based on the proportion of catch or landings from each sector during the most recent 15, 10, or 5 years through 2018, respectively. Final 2019 data from both sectors were not available during initial development of these alternatives; therefore, this Amendment only considers catch and landings data through 2018.

The fisheries have changed notably since the commercial/recreational allocations were first implemented in 1993 for summer flounder, 1997 for scup, and 1998 for black sea bass. Most notably, all three species were under rebuilding programs when these allocations were first implemented. According to the most recent stock assessment information, none of the three species are currently overfished or experiencing overfishing. Black sea bass and scup biomass levels are particularly high, at 237% and 198% of the target levels in 2018, respectively. Summer flounder biomass was at 78% of the target level in 2017.<sup>12</sup>

Other characteristics of the fisheries have also changed. Limited access programs for the commercial fisheries were implemented after the initial allocation base years. Possession limits and required minimum fish sizes in both sectors were implemented and have constrained both commercial and recreational harvest. Reporting and monitoring systems and requirements in both sectors have improved. Socioeconomic conditions such as demand for seafood and the demographics and number of both commercial and recreational fishermen have also shifted.

---

<sup>12</sup> Stock assessment reports for these species can be found at: <https://www.fisheries.noaa.gov/resource/publication-database/northeast-stock-assessment-documents-search-tool>.

## DRAFT AMENDMENT FOR PUBLIC COMMENT

For these reasons, this Amendment will consider allocation percentages based on more recent trends in the fisheries compared to the initial base years. The FMAT, Council, and Board agreed that the most recent 15, 10, and 5 years (through 2018) are reasonable time periods to consider.

During these time periods, the fisheries were theoretically constrained by the current allocations. However, the commercial fisheries were generally held closer to their allocations than the recreational fisheries, even when measuring recreational harvest with the pre-calibration MRIP data available prior to 2018. Due to the nature of these fisheries, the commercial fisheries have been much more comprehensively monitored in a more timely manner than recreational fisheries during these time periods. All federally permitted commercial fishermen are required to sell their catch to federally permitted dealers, and those dealers must submit landings reports on a weekly basis. If commercial fisheries are projected to land their full quota prior to the end of the year or quota period, they can be shut down. The commercial fisheries have rarely exceeded their quotas by notable amounts over the past 15 years due to close monitoring and reporting.

Recreational harvest is monitored through a combination of voluntary responses to MRIP surveys and VTR data from federally permitted for-hire vessels. Preliminary MRIP data are provided in two month “wave” increments and are not released until approximately two months after the end of the wave. Final recreational data are generally not available until the spring of the following year. Due to the delay in data availability, in-season closures are not used for these recreational fisheries. Recreational fisheries are primarily managed with a combination of possession limits, minimum fish sizes, and open/closed seasons that are projected to constrain harvest to a certain level. However, recreational harvest is influenced by a number of external factors, and the level of harvest associated with a specific combination of possession limits, minimum fish sizes, and open/closed seasons can be difficult to accurately predict. Compared to commercial effort, recreational effort is more challenging to manage, especially considering the recreational sector is an open access fishery. For these reasons, recreational harvest is not as tightly controlled and monitored as commercial landings.

In summary, there are tradeoffs associated with allocations based on recent fishery performance. These allocations could better reflect the current needs of the fisheries and be more responsive to changes in the fisheries and stocks compared to allocations using the initial base years. However, these alternatives would reallocate based on time periods when the recreational fishery was effectively less constrained to their limits than the commercial fishery. The implications may be different for each of the three species, and the issues should be carefully considered. From 2004-2018, scup tended to have more consistent quota and RHL underages in both sectors than summer flounder and black sea bass, and black sea bass had much more consistent RHL overages than the other two species (in all cases considering the pre-calibration MRIP data available prior to 2018).



***Approach F: Approximate status quo harvest per sector compared to 2017/2018 (summer flounder) or 2018/2019 (scup, black sea bass)***

Rationale

The intent behind this approach is to modify the percentage allocations to allow for roughly status quo landings in both sectors under the 2020-2021 ABCs for all three species compared to year(s) prior to the recent catch limit revisions based on the most recent stock assessments. This approach was developed prior to the August 2020 Council and Board meeting when both groups agreed to revise the 2021 ABCs for all three species; therefore, this approach considers the previously implemented 2021 ABCs. Compared to the previously implemented 2021 ABCs, the revisions approved by the Council and Board in August 2020 represent an increase of 8% for summer flounder, 13% for scup, and 9% for black sea bass.

The most recent stock assessments for all three species incorporated the revised MRIP data as well as updated commercial fishery data and fishery-independent data through 2017 for summer flounder and 2018 for scup and black sea bass. Catch and landings limits based on these assessments were implemented in 2019-2021 for summer flounder and 2020-2021 for scup and black sea bass. Identical catch and landings limits across each year were implemented for summer flounder and black sea bass. For scup, the catch and landings limits varied across 2020-2021.

For summer flounder, these changes resulted in a 49% increase in the commercial quota and RHL in 2019 compared to 2018. Despite the increase in the RHL, recreational management measures could not be liberalized because the revised MRIP data showed that the recreational fishery was already harvesting close to the increased RHL. The increased commercial quota allowed for an increase in commercial landings.

For black sea bass, these changes resulted in a 59% increase in the commercial quota and RHL for 2020 compared to 2019. Status quo recreational measures for black sea bass were expected to result in an overage of the increased 2020 RHL; however, the Council, Board, and NOAA Fisheries agreed to maintain status quo recreational management measures for 2020 to allow more time to consider how to best modify recreational management in light of the new MRIP data. Commercial landings appear to have increased in response to the increase in the quota; however, they are not likely to increase by the full 59% due to the impacts of the COVID-19 pandemic on market demand.

For scup, these changes resulted in a decrease in the commercial quota (-7%) and RHL (-12%) in 2020 compared to 2019. Status quo recreational measures for scup in 2020 were maintained based on similar justifications described above for black sea bass as well as the expectation that the commercial fishery would continue to under-harvest their quota due to market reasons. Given these circumstances, an attempt was made to calculate revised commercial/recreational allocations for all three species such that harvest in each sector could remain similar to pre-2019 levels for summer flounder and pre-2020 levels for scup and black sea bass (i.e., the years prior to implementation of the most recent stock assessments for all three species), at least on

a short-term basis under the current ABCs. This would require lower commercial quotas than those currently implemented for all three species. However, the Council and Board agreed that this approach warrants further consideration given that the commercial quotas for summer flounder and black sea bass increased by 49% and 59% respectively as a result of the most recent stock assessments, the commercial scup quota has been under-harvested for over 10 years. The recreational black sea bass and scup fisheries are facing the potential for severe restrictions based on a comparison of the revised MRIP data in recent years to the current RHLs under the existing allocations.

*Defining status quo for each species and sector*

Due to unique circumstances in each fishery, the status quo harvest target under this approach was not defined the same way across all species and sectors. Recreational harvest can vary notably from year to year, even under similar management measures. For this reason, recreational status quo for all three species was defined as average recreational harvest in pounds during the two years prior to the most recent catch limit revisions (i.e., 2017-2018 for summer flounder and 2018-2019 for scup and black sea bass). Commercial scup landings are also variable and have been below the quota since 2007 for market reasons. Therefore, status quo for the commercial scup fishery was also defined as a recent two-year average of harvest (2018-2019). For summer flounder and black sea bass, commercial status quo was defined as landings in the last year prior to revisions based on the most recent assessments (i.e., 2018 for summer flounder and 2019 for black sea bass). This reflects the fact that commercial summer flounder and black sea bass landings are generally close to the quotas. Status quo levels of discards for each species and sector were defined using the same years described above for landings. At the time that this approach was developed, discard estimates in weight for 2019 were not available for either sector; therefore, it was assumed that 2019 discards would be equal to the 2016-2018 average for all species and sectors. Because the Council and Board approved specific allocation alternatives in August 2020, this analysis was not updated with the 2019 discard data that has since become available.

*Methodology for calculating allocations*

This approach considers the 2020 - 2021 ABCs (or, in the case of scup, the average of the 2020 and 2021 ABCs). Because this approach would modify the commercial/recreational allocation percentages, expected harvest and discards in each sector could not be calculated with the same methods used for setting the 2020-2021 specifications. Instead, initial values for expected dead discards by sector were calculated by dividing the 2020-2021 ABCs into expected total (i.e., both sectors combined) landings and total dead discards based on the average proportion of total landings and dead discards during 2017-2019 (see note above about 2019 discards). The expected total amount of dead discards was then divided into commercial and recreational discards based on the average contribution of each sector to total dead discards during 2017-2019. Initial expected harvest was defined as the status quo level of landings in each sector described above. These were the target commercial quotas and RHLs. As described below,

these initial values for both harvest and dead discards were modified during subsequent steps of the analysis.

For summer flounder, total expected catch was 18% below the 2020-2021 ABC. This surplus allowable catch was split evenly among the two sectors. The resulting catch and landings limits, including expected dead discards in each sector, were modified to account for this surplus. For scup, total expected catch was 9% above the 2020-2021 average ABC. For black sea bass, total expected catch was 2% above the 2020-2021 ABC. For both scup and black sea bass, the catch reduction necessary to prevent an ABC overage was evenly split between the two sectors. Thus, true status quo was not be maintained for any of the three species under this example. For summer flounder, both sectors were able to slightly liberalize compared to the definition of status quo described above. For scup and black sea bass, both sectors had to be slightly restricted. The resulting catch and landings limits were then used to define the allocation percentages in Table 40. These are the allocation percentages for consideration under this approach.

**Table 40. Allocations aiming to allow approximately status quo landings in each sector under the 2020-2021 ABCs compared to recent years prior to catch limit revisions based on the most recent stock assessments.**

Sector	Catch-based			Landings-based		
	Summer flounder	Scup	Black sea bass	Summer flounder	Scup	Black sea bass
Commercial	43%	59%	32%	43%	50%	29%
Recreational	57%	41%	68%	57%	50%	71%

***Approach G (average of other approaches approved by Council/Board in June 2020)***

The FMAT developed several allocation alternatives during May and June 2020. Many of these approaches resulted in very similar allocation percentages. The Council and Board refined the list of alternatives under consideration in June 2020 and agreed that it would be appropriate to consider an option for each species that averages the other alternatives in recognition of the similarities in outcomes across many alternatives.

Although this approach does not have a quantitative basis that is distinct from the other alternatives, the FMAT agreed that this is appropriate. They also emphasized that there is not necessarily a clear, objective scientific basis for a single best way to approach these allocations, and that the final decision will be a policy and judgement call between a number of defensible options.

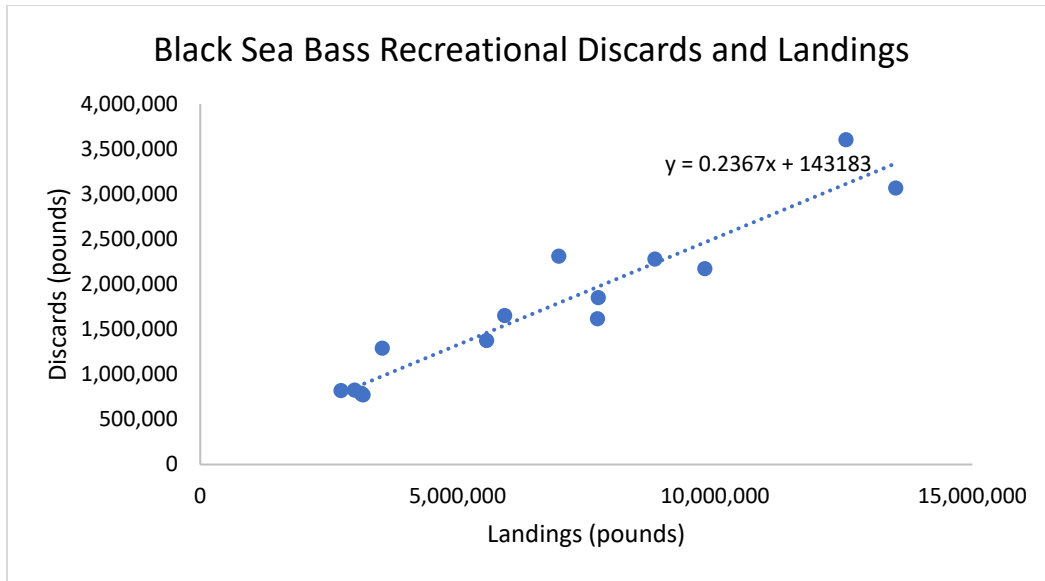
## **APPENDIX II: EXAMPLE QUOTAS AND RHLs UNDER EACH ALLOCATION ALTERNATIVE**

This appendix provides examples of potential quotas and RHLs for each of the commercial/recreational allocation percentage alternatives listed in alternative sets 1a-1c (Table 19). Commercial quotas and RHLs are developed or reviewed annually through consultation with the MC and approved upon Council and Board review. As described below, given several assumptions that need to be made about how dead discards are handled, it is not possible to precisely predict what quotas and harvest limits would be under each allocation. This analysis provides the best approximation of possible limits available at this time.

### ***Dead Discard Projection Methodology***

Projecting dead discards is a key component in developing landings limits. Typically, summer flounder and scup total dead discards are based on the stock assessment projections and black sea bass total dead discards are based on a 3-year average of dead discards as a percent of total dead catch. The MC then takes into consideration recent trends and other relevant factors to split the total projected dead discards into dead discards by sector. Projecting expected future commercial quotas and RHLs under revised allocations is complicated because large shifts in allocations are expected to impact recreational and commercial effort, which may result in changes in dead discards for each sector in addition to changes in landings. As such, under modified allocations there would be a transition period where recent trends in dead discards by sector would not be particularly informative for projecting what sector discards would be under new allocations. Expected dead discards by sector under revised allocations are thus better predicted by modeling the relationship between dead catch, landings and discards. This can then be used to project dead discards under example catch and landings limits for each allocation alternative. The modeling process involves assumptions and like any model it is imperfect, but hopefully informative as well. This method is not necessarily the method that the MC will have to use in future specifications development, and they will still have the opportunity to adjust the dead discard projections based on expected changes in stock size, or year class strength, recent changes in management measures, and recent changes in fishing effort.

The following methodology for producing dead discard projections was based on the assumption that there is a relationship between dead discards and catch/landings. Examination of recent trends in black sea bass dead discards and catch/landings reveals a strong positive linear relationship in both the recreational and the commercial fisheries. This is to be expected for catch which is comprised of both landings and discards, but the positive relationship between landings and dead discards is informative for the projection of dead discards. As an example, Figure 37 displays a scatterplot of black sea bass recreational discards and landings for reference. The positive relationship between dead discards was also present in the commercial and recreational scup and summer flounder fisheries.

**Figure 37. Scatterplot of black sea bass recreational discards and landings (2004-2018).**

#### ***Deriving Landings Limits for Catch-based Allocation Shares***

Projecting discards for catch-based allocations relies upon simple linear regression with catch as the dependent variable and discards as the independent variable. As such, discards were regressed on catch for the years 2004-2018 for all three species by sector. While the coefficients for catch were not statistically significant at the 90% confidence interval for all species and sectors, in all instances the regression analyses revealed a positive linear relationship. The regression output provides an understanding of how discards scale with catch. By combining this understanding with an example ABC and a specific allocation share, it becomes possible to project a RHL and commercial quota for each allocation alternative.

#### ***Deriving Landings Limits for Landings-Based Allocations***

Projecting landings limits for landings-based allocations also relies upon simple linear regression, but with landings as the independent variable and discards as the dependent variable. Discards were regressed on landings for the years 2004-2018 for all three species by sector. Although the coefficients for landings were not all statistically significant at the 90% the regression analyses did reveal a positive linear relationship for all three species. The use of regression analysis provides a model for how discards may potentially scale with landings. Through algebraic manipulation, it is possible to solve for the RHL and commercial quota given a specific allocation share and an example ABC.

#### ***Example RHLs and Quotas Under Allocation Alternatives***

The following tables provide the example commercial quotas and RHLs for each species under each allocation alternative using the methodology described above. As previously stated, the regressions were based on landings and discards data from 2004-2018. In addition, the 2020

DRAFT AMENDMENT FOR PUBLIC COMMENT

ABC value was used. For the status quo allocation alternatives, the actual 2020 commercial quota and RHL values are displayed for comparison.

When interpreting these tables, it may be helpful to also reference the basis for each alternative as described in more detail in Appendix I, an explanation of the implications of catch versus landings-based allocations in Section 1.3.5, and view a comparison of recent landings trends to the projected landings limits for each allocation alternative (including status quo which is highlighted) in Section 4.4.1.

**Table 41. Black sea bass example quotas and RHLs in millions of pounds, under 2020 ABC of 15.07 million pounds.**

<b>Black Sea Bass</b>							
2020 ABC: 15.07 mil lb.	CATCH-BASED			LANDINGS-BASED			
Alternative	1c-1	1c-2	1c-3	1c-4 <sup>a</sup>	1c-5	1c-6	1c-7
<b>Com. allocation</b>	<b>32%</b>	<b>28%</b>	<b>24%</b>	<b>49%</b>	<b>45%</b>	<b>29%</b>	<b>22%</b>
<b>Rec. allocation</b>	<b>68%</b>	<b>72%</b>	<b>76%</b>	<b>51%</b>	<b>55%</b>	<b>71%</b>	<b>78%</b>
Commercial ACL	4.82	4.22	3.62	7.94	7.32	4.69	3.47
Commercial discards	1.51	1.23	0.95	2.51	2.28	1.31	0.85
<b>Commercial quota</b>	<b>3.31</b>	<b>2.99</b>	<b>2.66</b>	<b>5.43</b>	<b>5.04</b>	<b>3.38</b>	<b>2.61</b>
Recreational ACL	10.25	10.85	11.45	7.13	7.75	10.38	11.60
Recreational discards	2.08	2.20	2.32	1.48	1.60	2.10	2.34
<b>RHL</b>	<b>8.16</b>	<b>8.65</b>	<b>9.14</b>	<b>5.65</b>	<b>6.15</b>	<b>8.28</b>	<b>9.27</b>

<sup>a</sup> This is the no action/status quo alternative. The values shown here represent the catch and landings limits implemented in 2020, not example measures using the methodology described in this appendix.

**Table 42. Scup example quotas and RHLs in millions of pounds, under 2020 ABC of 35.77 million pounds.**

<b>Scup</b>							
2020 ABC: 35.77 mil lb.	CATCH-BASED				LANDINGS-BASED		
Alternative	1b-1 <sup>a</sup>	1b-2	1b-3	1b-4	1b-5	1b-6	1b-7
<b>Com. allocation</b>	<b>78%</b>	<b>65%</b>	<b>61%</b>	<b>59%</b>	<b>57%</b>	<b>56%</b>	<b>50%</b>
<b>Rec. allocation</b>	<b>22%</b>	<b>35%</b>	<b>39%</b>	<b>41%</b>	<b>43%</b>	<b>44%</b>	<b>50%</b>
Commercial ACL	27.90	23.25	21.82	21.10	21.49	21.18	19.27
Commercial discards	5.67	6.35	5.90	5.67	4.65	4.62	4.46
<b>Commercial quota</b>	<b>22.23</b>	<b>16.90</b>	<b>15.92</b>	<b>15.44</b>	<b>16.85</b>	<b>16.56</b>	<b>14.81</b>
Recreational ACL	7.87	12.52	13.95	14.67	14.28	14.59	16.50
Recreational discards	1.36	1.48	1.58	1.62	1.57	1.59	1.70
<b>RHL</b>	<b>6.51</b>	<b>11.04</b>	<b>12.37</b>	<b>13.04</b>	<b>12.71</b>	<b>13.01</b>	<b>14.81</b>

<sup>a</sup> This is the no action/status quo alternative. The values shown here represent the catch and landings limits implemented in 2020, not example measures using the methodology described in this appendix.

**Table 43. Summer flounder example quotas and RHLs in millions of pounds, under 2020 ABC of 25.03 million pounds.**

<b>Summer Flounder</b>							
2020 ABC: 25.03 mil lb.	CATCH-BASED			LANDINGS-BASED			
Alternative	1a-1	1a-2	1a-3	1a-4 <sup>a</sup>	1a-5	1a-6	1a-7
<b>Com. allocation</b>	<b>44%</b>	<b>43%</b>	<b>40%</b>	<b>60%</b>	<b>55%</b>	<b>45%</b>	<b>41%</b>
<b>Rec. allocation</b>	<b>56%</b>	<b>57%</b>	<b>60%</b>	<b>40%</b>	<b>45%</b>	<b>55%</b>	<b>59%</b>
Commercial ACL	11.01	10.76	10.01	13.67	12.69	10.72	9.92
Commercial discards	2.22	2.19	2.10	2.58	2.49	2.33	2.26
<b>Commercial quota</b>	<b>8.79</b>	<b>8.57</b>	<b>7.92</b>	<b>11.10</b>	<b>10.20</b>	<b>8.38</b>	<b>7.65</b>
Recreational ACL	14.02	14.27	15.02	11.36	12.34	14.31	15.11
Recreational discards	3.77	3.80	3.87	3.96	3.99	4.07	4.10
<b>RHL</b>	<b>10.24</b>	<b>10.47</b>	<b>11.15</b>	<b>7.40</b>	<b>8.34</b>	<b>10.25</b>	<b>11.02</b>

<sup>a</sup> This is the no action/status quo alternative. The values shown here represent the catch and landings limits implemented in 2020, not example measures using the methodology described in this appendix.

### **APPENDIX III: ACRONYMS AND ABBREVIATIONS**

ABC	Acceptable Biological Catch
ACL	Annual Catch Limit
ACT	Annual Catch Target
ACCSP	Atlantic Coastal Cooperative Statistics Program
ACFCMA	Atlantic Coastal Fisheries Cooperative Management Act
AM	Accountability Measure
AP	Advisory Panel
Board	The Commission's Summer Flounder, Scup, and Black Sea Bass Management Board
Commission	Atlantic States Marine Fisheries Commission
Council	Mid-Atlantic Fishery Management Council
EEZ	Economic Exclusive Zone
EFH	Essential Fish Habitat
FMAT	Fishery Management Action Team
FMP	Fishery Management Plan
MC	Monitoring Committee
MRIP	Marine Recreational Information Program
MSA	Magnuson-Stevenson Act
NEFSC	Northeast Fisheries Science Center
RHL	Recreational Harvest Limit
SFA	Sustainable Fisheries Act
TAL	Total Allowable Landings
VTR	Vessel Trip Report