

Summer Flounder, Scup, and Black Sea Bass Commercial/Recreational Allocation Amendment

PUBLIC HEARING DOCUMENT

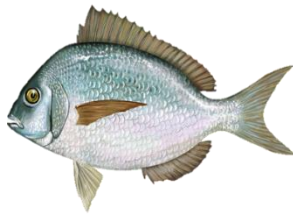

January 2021

Prepared by the
Mid-Atlantic Fishery Management Council
and the
Atlantic States Marine Fisheries Commission



1.0 CONTENTS

1.0	CONTENTS	2
2.0	INSTRUCTIONS FOR PROVIDING PUBLIC COMMENTS	3
3.0	INTRODUCTION AND AMENDMENT PURPOSE	5
3.1	Amendment Purpose.....	5
3.2	Need for Action	5
3.3	What Happens Next?	7
4.0	COMMERCIAL/RECREATIONAL ALLOCATION ALTERNATIVES AND IMPACTS	7
4.1	Commercial/Recreational Allocation Alternatives.....	10
4.1.1	Summer Flounder Allocation Alternatives	10
4.1.2	Scup Allocation Alternatives	11
4.1.3	Black Sea Bass Allocation Alternatives	12
4.2	Impacts of Commercial/Recreational Allocation Alternatives.....	12
4.2.1	General Impacts of Allocation Changes on All Three Species	13
4.2.2	Summer Flounder Allocation Impacts	16
4.2.3	Scup Allocation Impacts	20
4.2.4	Black Sea Bass Allocation Impacts	23
4.3	Allocation Change Phase-In.....	27
4.3.1	Allocation Change Phase-In Alternatives	27
4.3.2	Impacts of Allocation Change Phase-In Alternatives.....	27
5.0	QUOTA TRANSFER ALTERNATIVES AND IMPACTS	38
5.1	Quota Transfer Provision Alternatives	38
5.1.1	Quota Transfer Process Alternatives	38
5.1.2	Transfer Cap Alternatives	40
5.2	Impacts of Quota Transfer Provision Alternatives	40
5.2.1	Impacts of the Proposed Process	41
5.2.2	Socioeconomic Impacts of Transfers.....	42
5.2.3	Impacts of Transfer Cap Alternatives.....	44
6.0	FRAMEWORK/ADDENDUM PROVISION ALTERNATIVES AND IMPACTS	45
6.1	Framework/Addendum Provision Alternatives	45
6.2	Impacts of Framework/Addendum Provision Alternatives.....	46
7.0	APPENDICES	47
	APPENDIX A: Catch vs. Landings-Based Allocations	47
	APPENDIX B: Supplemental Information on Basis for Allocation Alternatives.....	55
	Approach A (no action/status quo)	55
	Approach B (same base years as current allocations but with new data)	55
	Approach C (2004-2018 base years), approach D (2009-2018 base years), and approach E (2014-2018 base years)	56
	Approach F: Approximate status quo harvest per sector compared to 2017/2018 (summer flounder) or 2018/2019 (scup, black sea bass)	57
	Approach G (average of other approaches approved by Council/Board in June 2020)	59
	APPENDIX C: Example Quotas and RHLs Under Each Allocation Alternative.....	61
	APPENDIX D: Acronyms and Abbreviations.....	65

2.0 INSTRUCTIONS FOR PROVIDING PUBLIC COMMENTS

The Mid-Atlantic Fishery Management Council (Council) and the Atlantic States Marine Fisheries Commission (Commission), through its Summer Flounder, Scup and Black Sea Bass Management Board (Board), are seeking public comment on the Summer Flounder, Scup, and Black Sea Bass Commercial/Recreational Allocation Amendment. **Specifically, the Council and Board are asking commenters to identify their preferred allocation alternatives by species under Section 4, and their preferred quota transfer process and caps alternatives under Section 5. Additionally, comments are sought regarding whether future changes to these measures can be made through the framework/addendum process versus the amendment process.**

The Council and Commission work cooperatively to develop commercial and recreational fishery regulations for summer flounder, scup, and black sea bass from Maine through North Carolina (north of Cape Hatteras for scup and black sea bass). The National Marine Fisheries Service (NMFS) serves as the federal implementation and enforcement entity. This cooperative management endeavor was developed because a significant portion of the catch for all three species is taken from both state (0-3 miles offshore) and federal waters (3-200 miles offshore).

Comments may be submitted at any of five virtual public hearings to be held between February 17 and March 2, 2021 or via written comment until March 16, 2021. Written comments may be sent by any of the following methods:

1. **Online** at <https://www.mafmc.org/comments/sfsbsb-allocation-amendment>
2. **Email** to the following address: kdancy@mafmc.org
3. **Mail or Fax** to:

Chris Moore, Ph.D., Executive Director
Mid-Atlantic Fishery Management Council
800 North State Street, Suite 201
Dover, DE 19901
FAX: 302.674.5399

If sending comments through the mail, please write **“Summer Flounder, Scup, Sea Bass Allocation Amendment”** on the outside of the envelope. If sending comments through email or fax, please write **“Summer Flounder, Scup, Sea Bass Allocation Amendment”** in the subject line.

All comments, regardless of submission method, will be compiled for review and consideration by both the Council and Commission. **It is not necessary to separately submit comments to the Council and Commission or submit the same comments through multiple channels.**

You are encouraged to attend any of the following five virtual public hearings and to provide oral or written comments at these hearings. Each hearing is targeted toward regional groupings of states or an individual state; however, anyone is welcome to participate in any hearing.

Date and Time	Regional Grouping and Webinar Link
Wednesday, February 17 6-8pm	Massachusetts and Rhode Island
Thursday, February 18 6-8pm	New Jersey
Wednesday, February 24 6-8pm	Delaware and Maryland
Monday, March 1 6-8pm	Virginia and North Carolina
Tuesday, March 2 6-8pm	Connecticut and New York

Webinar Information: You can access GoToWebinar through your computer, tablet, or smartphone. To download the software, click here or search for “GoToWebinar” in the app store on your smart phone or tablet. We recommend you register for the hearing well in advance. GoToWebinar will provide you with a link to test your device’s compatibility with the webinar. If you find your device is not compatible, please contact the Commission at info@asmfc.org (subject line: GoToWebinar help) and Commission staff will try to get you connected. We also strongly encourage participants to use the computer voice over internet (VoIP) so you can ask questions and provide input at the hearing. To attend the webinar by phone in listen only mode, dial 1-877-309-2074 and enter access code 128-060-916. Those joining by phone only will be limited to listening to the presentation and will not be able to provide input. In those cases, you can send your comments to staff via email, mail, or fax at any time during the public comment period.

To register for a public hearing please click here: [Public Hearing Registration](#). Webinar information will also be posted on the event calendar at <https://www.mafmc.org/>.

For additional information and updates, please visit: <https://www.mafmc.org/actions/sfsbsb-allocation-amendment>. If you have any questions, please contact either:

Commission Contact
Dustin Colson Leaning
dleaning@asmfc.org
703.842.0714

Council Contact
Kiley Dancy
kdancy@mafmc.org
302.526.5257

Tips for Providing Public Comment

We value your input. To be most effective, we request that your comment include specific details as to why you support or oppose a particular alternative. Specifically, please address the following:

- Which proposed alternative(s) do you support, and which do you oppose?
- Why do you support or oppose the alternative(s)?
- Is there any additional information you think should be considered?

3.0 INTRODUCTION AND AMENDMENT PURPOSE

3.1 Amendment Purpose

The purposes of this amendment are to:

- 1) Consider modifications to the current allocations between the commercial and recreational sectors for summer flounder, scup, and black sea bass (Section 4.0). The commercial and recreational allocations for all three species are currently based on historical proportions of landings (for summer flounder and black sea bass) or catch (for scup) from each sector. The current allocations were set in the mid-1990s and have not been revised since that time.
- 2) Consider the option to transfer a portion of the allowable landings each year between the commercial and recreational sectors, in either direction, based on the needs of each sector (Section 5.0). The current Fishery Management Plan (FMP) does not allow for such transfers.
- 3) Consider whether future additional modifications to the commercial/recreational allocation and/or transfer provisions can be considered through a future FMP addendum/framework action, as opposed to an amendment (Section 6.0).

Several other issues identified during scoping for this action were considered by the Council and Board but have since been removed from further consideration in this amendment. Some of those issues will be further considered through other initiatives or actions. For more information, see the documents associated with past meetings for this amendment, available at:

<https://www.mafmc.org/actions/sfsbsb-allocation-amendment>.

3.2 Need for Action

The commercial and recreational allocations for all three species are currently based on historical proportions of landings (for summer flounder and black sea bass) or catch (for scup) from each sector. Recent changes in how recreational catch is estimated have resulted in a discrepancy between the current levels of estimated recreational harvest and the allocations of summer flounder, scup, and black sea bass to the recreational sector.

Recreational catch and harvest data are estimated by the Marine Recreational Information Program (MRIP). In July 2018, MRIP released revised time series of catch and harvest estimates based on adjustments to its angler intercept methodology, which is used to estimate catch rates, as well as changes to its effort estimation methodology, namely, a transition from a telephone-based effort survey to a mail-based effort survey for the private/rental boat and shore-based fishing modes.¹ These revisions collectively resulted in much higher recreational catch estimates compared to previous estimates, affecting the entire time series of data going back to 1981.

The revised MRIP estimates were incorporated into the stock assessments for summer flounder in 2018 and for scup and black sea bass in 2019. This impacted the estimated stock biomass and resulting catch limits for these species. In general, because the revised MRIP data showed that more fish were caught than previously thought, the stock assessment models estimated that there were more fish available to catch, which in turn impacted the biomass estimates derived from the

¹ For-hire effort continues to be assessed through a telephone survey of known for-hire operators. More information on how MRIP collects data from the recreational fishery is available at: <https://www.fisheries.noaa.gov/recreational-fishing-data/types-recreational-fishing-surveys>.

stock assessments. However, for each species, the revised MRIP data were one of many factors that impacted the stock assessments and the resulting catch limits. Other factors such as the addition of data on recent recruitment also impacted the assessment model results.

- For summer flounder, the revised MRIP estimates were 30% higher on average compared to the previous estimates for 1981-2017. The differences between the previous and revised estimates tended to be greater in more recent years compared to earlier years. Increased recreational catch resulted in increased estimates of stock size compared to past assessments. The higher biomass projections resulted in a 49% increase in the commercial quota and recreational harvest limit (RHL) for 2019. Expected recreational harvest in the new MRIP currency was close to the revised RHL; therefore, recreational measures could not be liberalized in 2019 despite the 49% increase in the RHL.
- For scup, the revised MRIP recreational catch estimates were, on average, 18% higher than the previous estimates for 1981-2017. The differences between the previous and revised estimates tended to be greater in more recent years compared to earlier years. The MRIP data have a lesser impact in the scup stock assessment model, with the 2019 operational stock assessment showing minor increases in biomass estimates compared to the 2015 assessment. Due to below-average recruitment in recent years, the scup catch and landings limits for both the commercial and recreational sectors decreased slightly as a result of biomass projections provided with the 2019 operational stock assessment.
- For black sea bass, the revised MRIP recreational catch estimates increased the 1981-2017 total catch by an average of 73%, ranging from +9% in 1995 to +161% in 2017. As with summer flounder and scup, the differences between the previous and revised estimates tended to be greater in more recent years compared to earlier years. These increased catch estimates combined with an above average 2015 year class contributed to a notable scaling up of the spawning stock biomass estimates from the previous assessment. As a result, the 2020 black sea bass commercial quota and RHL both increased by 59% compared to 2019. Recent harvest under the new MRIP data was higher than the 2020 RHL, therefore, recreational management measures could not be liberalized.

Some changes have also been made to commercial catch data since the allocations were established. For example, the time series of commercial scup discard estimates was revised through the 2015 scup stock assessment. For the 1988-1992 allocation base years, the current estimates of scup commercial catch are on average 8% lower than the estimates used to set the allocations under Amendment 8.

The commercial and recreational data revisions not only impact the catch estimates, but also significantly affected our understanding of the population levels for all three fish stocks. This has management implications due to the fixed commercial/recreational allocation percentages defined in the FMP for all three species. These allocation percentages do not reflect the current understanding of the recent and historic proportions of catch and landings from the commercial and recreational sectors. These allocation percentages are defined in the Council and Commission FMPs; therefore, they can only be modified through an FMP amendment. This amendment will consider whether the allocations are still appropriate and meeting the objectives of the FMP, as well as other potential changes related to how the allocations are managed, as described in Sections 5 and 6.

3.3 What Happens Next?

This document is intended to solicit public comment via public hearings in February and March 2021 and through written input during the public comment period which will be open through March 16, 2021. Following this period, written and oral comments will be compiled and provided to the Council and Board for review. These comments will be considered prior to taking final action on the amendment, which is tentatively scheduled for April 2021. While the Commission's actions are final for state waters (0-3 miles from shore) upon approval of the amendment unless otherwise specified, the Council's recommendations are not final until they are approved by the Secretary of Commerce through the National Marine Fisheries Service. Therefore, the timing of full implementation of this action will depend on the federal rulemaking timeline. This rulemaking process is expected to occur in 2021, with the intent for revised measures (if applicable) to be effective at the start of the 2022 fishing year.

4.0 COMMERCIAL/RECREATIONAL ALLOCATION ALTERNATIVES AND IMPACTS

This section describes the alternatives under consideration for the commercial/recreational allocation percentages for summer flounder, scup, and black sea bass (Section 4.1), along with their expected impacts (Section 4.2). The basis for each alternative is described in more detail in Appendix B. The range of allocation alternatives for each species includes options that would maintain the current allocations as well as options to revise them based on updated data using the same or modified base years. Section 4.3 describes options to phase in any allocation changes over multiple years, as well as the expected impacts of these phase-in provisions.

Alternatives for both catch-based and landings-based allocations are under consideration for all three species. As described in more detail in Appendix A, the same types of catch and landings limits are required under both catch and landings-based allocations (i.e., commercial and recreational annual catch limits, or ACLs, and annual catch targets, commercial quota, and RHL). Dead discards (i.e., discarded fish that are assumed to die)² must be accounted for in the catch limits under both allocation approaches. Under both approaches, dead discards are subtracted from the catch limits to derive the sector-specific landings limit. **The main difference between these approaches is the step in the calculations where the commercial/ recreational allocation percentage is applied.** This has implications for how those dead discards are factored into the calculations.

Catch-based allocations (currently in place for scup) apply the commercial/recreational allocation at the acceptable biological catch (ABC) level, meaning the entire amount of allowable catch (i.e., the ABC, which includes landings and dead discards) would be split based on the commercial/recreational allocation percentage defined through the alternatives listed below. Under a landings-based allocation (currently in place for summer flounder and black sea bass), the ABC is first split into the amount expected to come from landings and the amount expected to come

² The current discard mortality rates assumed in the stock assessments and catch and landings limits calculations are: 10% for recreational summer flounder discards and 80% for commercial summer flounder discards; 15% for scup recreational discards and 100% for commercial scup discards; 15% for recreational black sea bass discards, 15% for commercial non-trawl black sea bass discards, and 100% for commercial trawl black sea bass discards. These discard mortality rates are used in all aspects of the management program which utilize estimates of dead discards.

from dead discards. The expected landings amount is then split according to the commercial/recreational allocation percentage defined through the alternatives listed below.

It is important to note that **because expected dead discards are handled differently under catch and landings-based approaches, the allocation percentages under these two approaches are not directly comparable.** To allow for comparison across all alternatives, example resulting commercial quotas and RHLs for each species are provided in Section 4.2 (see Appendix C for details on how these example quotas and RHLs were calculated). Actual resulting commercial quotas and RHLs will vary based on annual considerations.

Table 1 provides a summary comparison of the key differences and similarities between catch- and landings-based allocations. The implications of catch vs. landings-based allocations are further discussed in Appendix A and in Section 4.2.

Table 1: Summary of the differences and similarities between catch- and landings-based allocations.

Catch-based allocations	Landings-based allocations
<ul style="list-style-type: none"> • Currently in place for scup. • Allocation at ABC level as first step: total catch (landings + dead discards) split into recreational and commercial ACLs based on allocation percentage defined in FMP. • The entire ABC is always split among the sectors based on the allocation defined in the FMP, regardless of recent trends in landings and discards by sector. Because of this, changes in landings and dead discards in one sector do not influence the other sector’s ACL. • Expected dead discards are calculated separately for each sector to subtract from the sector ACLs to determine the sector landings limits 	<ul style="list-style-type: none"> • Currently in place for summer flounder and black sea bass. • ABC is first split into the amount expected to come from landings (Total Allowable Landings, or TAL) and the amount expected to come from dead discards. The methodology for this split is not pre-defined and is usually based on recent trends in landings and dead discards, as well as stock assessment projections where possible. • Allocation at TAL level: TAL is allocated among the commercial and recreational sectors based on the allocation percentage defined in the FMP. • Total expected dead discards are split by sector based on different methods, usually recent trends in discards by sector. The sector specific expected dead discards are subtracted from the sector ACLs to derive the sector landings limits. • Changes in landings and dead discards in one sector over time can impact the catch and landings limits in both sectors by impacting the division of the ABC into expected landings and expected dead discards.
<p>Under Both Approaches:</p> <ul style="list-style-type: none"> • Commercial and recreational ACLs, annual catch targets, and landings limits (i.e., commercial quota and RHL) are required. • Expected dead discards must be projected and accounted for by sector. • Only dead discards (discarded fish that are assumed to die) are accounted for in setting and evaluating catch limits. Neither allocation approach includes consideration of released fish that are assumed to survive. • Accountability measures are required for each sector and tied to sector-specific ACLs. Each sector is held separately accountable for any ACL overages. <p>The main difference between approaches is the step in the calculations at which the commercial/recreational allocation percentages are applied, which has implications for how expected dead discards are projected and divided by sector.</p>	

4.1 Commercial/Recreational Allocation Alternatives

4.1.1 Summer Flounder Allocation Alternatives

Table 2 lists the alternatives under consideration for the commercial/recreational summer flounder allocation percentages. The current allocations for summer flounder are landings-based and are represented by the no action/status quo alternative (alternative 1a-4). As described above, both catch- and landings-based alternatives are considered. The percentages under these alternatives are not directly comparable due to differences in how dead discards are addressed under catch-based allocations and landings-based allocations. Appendix C provides examples of potential commercial quotas and RHLs under each alternative to allow for more direct comparisons between the catch and landings-based alternatives. Appendix A provides more details on the differences between catch- and landings-based allocations and the potential implications of each approach. The rationale behind each allocation alternative is described in more detail in Appendix B.

The alternatives in this section are mutually exclusive, meaning the Council and Board can only choose one of the alternatives from 1a-1 through 1a-7.

Table 2: Summer flounder commercial/recreational allocation alternatives. The current allocations are highlighted in green.

Summer Flounder Catch-Based Allocation Percentages	
Alternative	Basis (see Appendix B for details)
1a-1: 44% commercial, 56% recreational	2004-2018 base years
1a-2: 43% commercial, 57% recreational	Supported by multiple approaches: 2009-2018 base years, approximate status quo harvest per sector compared to 2017/2018, and average of other approaches approved by Council/Board in June 2020
1a-3: 40% commercial, 60% recreational	2014-2018 base years
Summer Flounder Landings-Based Allocation Percentages	
Alternative	Basis (see Appendix B for details)
1a-4: 60% commercial, 40% recreational	No action/status quo (1980-1989)
1a-5: 55% commercial, 45% recreational	Same base years, new data (1981-1989; 1980 data unavailable)
1a-6: 45% commercial, 55% recreational	Multiple approaches: 2004-2018 and 2009-2018 base years
1a-7: 41% commercial, 59% recreational	2014-2018 base years

4.1.2 Scup Allocation Alternatives

Table 3 lists the alternatives under consideration for the commercial/recreational scup allocation percentages. The current allocations for scup are catch-based and are represented by the no action/status quo alternative (alternative 1b-1). As described above, both catch- and landings-based alternatives are considered. The percentages under these alternatives are not directly comparable due to differences in how dead discards are addressed under catch- and landings-based allocations. Appendix C provides examples of potential commercial quotas and RHLs under each alternative to allow for more direct comparisons between the catch and landings-based alternatives. Appendix A provides more details on the differences between catch and landings-based allocations and the potential implications of each approach. The rationale behind each allocation alternative is described in more detail in Appendix B.

The alternatives in this section are mutually exclusive, meaning the Council and Board can only choose one of the alternatives from 1b-1 through 1b-7.

Table 3: Scup commercial/recreational allocation alternatives. The current allocations are highlighted in green.

Scup Catch-Based Allocation Percentages	
Alternative	Basis (see Appendix B for details)
1b-1: 78% commercial, 22% recreational	No action/status quo
1b-2: 65% commercial, 35% recreational	Same base years, new data (1988-1992)
1b-3: 61% commercial, 39% recreational	Multiple approaches: 2009-2018 base years and average of other approaches approved by Council/Board in June 2020
1b-4: 59% commercial, 41% recreational	Approximate status quo harvest per sector compared to 2018/2019
Scup Landings-Based Allocation Percentages	
Alternative	Basis (see Appendix B for details)
1b-5: 57% commercial, 43% recreational	Multiple approaches: Same base years, new data; 2014-2018 base years; 2009-2018 base years
1b-6: 56% commercial, 44% recreational	2004-2018 base years
1b-7: 50% commercial, 50% recreational	Approximate status quo harvest per sector compared to 2018/2019

4.1.3 Black Sea Bass Allocation Alternatives

Table 4 lists the alternatives under consideration for the commercial/recreational black sea bass allocation percentages. The current allocations for black sea bass are landings-based and are represented by the no action/status quo alternative (alternative 1c-4). As described above, both catch- and landings-based alternatives are considered. The percentages under these alternatives are not directly comparable due to differences in how dead discards are addressed under catch-based allocations and landings-based allocations. Appendix C provides examples of potential commercial quotas and RHLs under each alternative to allow for more direct comparisons between the catch and landings-based alternatives. Appendix A provides more details on the differences between catch- and landings-based allocations and the potential implications of each approach. The rationale behind each allocation alternative is described in more detail in Appendix B.

The alternatives in this section are mutually exclusive, meaning the Council and Board can only choose one of the alternatives from 1c-1 through 1c-7.

Table 4: Black sea bass commercial/recreational allocation alternatives. The current allocations are highlighted in green.

Black Sea Bass Catch-Based Percentages	
Alternative	Basis (see Appendix B for details)
1c-1: 32% commercial, 68% recreational	Approximate status quo harvest per sector compared to 2018/2019
1c-2: 28% commercial, 72% recreational	2004-2018 base years
1c-3: 24% commercial, 76% recreational	2009-2018 base years
Black Sea Bass Landings-Based Percentages	
Alternative	Basis (see Appendix B for details)
1c-4: 49% commercial, 51% recreational	No action/status quo
1c-5: 45% commercial, 55% recreational	Same base years, new data (1983-1992)
1c-6: 29% commercial, 71% recreational	Multiple approaches: Approximate status quo harvest per sector compared to 2018/2019 and average of other approaches approved by Council/Board in June 2020
1c-7: 22% commercial, 78% recreational	2009-2018 and 2014-2018 base years

4.2 Impacts of Commercial/Recreational Allocation Alternatives

As described in more detail below, the impacts of these alternatives are expected to be mostly socioeconomic in nature. Potential biological impacts on the summer flounder, scup, and black sea bass stocks are also briefly discussed below. Impacts applicable to all three species are discussed in section 4.2.1, while species-specific impacts are outlined in sections 4.2.2 through 4.2.4. A more complete impacts analysis, including consideration of the potential impacts on other components

of the environment such as non-target species, habitats, marine mammals, and species listed as threatened or endangered under the Endangered Species Act, will be included in the Environmental Assessment prepared after the Council and Board select their final preferred alternatives.

Sections 4.2.2 through 4.2.4 contain example projected RHLs and commercial quotas for each allocation alternative to demonstrate potential impacts to the recreational and commercial fisheries. The 2020 ABC for each species was used to project landings limits that reflect recent stock size and to allow for comparison to recent fishery performance. The methodology used to develop the example landings limits differs from the methodology that was used to develop the actual landings limits that were implemented for management use in 2020. For the status quo alternatives for each species, the actual 2020 RHLs and commercial quotas are presented. For the other alternatives, use of a different method was necessary to allow for several assumptions that must be made about how dead discards by sector would be projected, including the effect that changing allocations could have on each sector's fishing effort and dead discards. A more detailed description of the methodology used to generate example RHLs and quotas can be found in Appendix C.

Actual future commercial quotas and RHLs under any of these alternatives cannot be determined at this time and may differ from the examples presented here based on future ABCs, which are unknown beyond 2021 as they are driven by stock assessment projections. In addition, annual assumptions about expected dead discards (total and sector-specific) may vary in future years, which will also impact future RHLs and commercial quotas. The example commercial quotas and RHLs in this document are provided only for the purposes of assessing the potential impacts of each alternative and for comparing between the alternatives.

4.2.1 General Impacts of Allocation Changes on All Three Species

Socioeconomic Impacts

Aside from the no action/status quo alternatives, all alternatives for all three species would result in an increased recreational allocation. This would result in higher RHLs than the current allocations. RHLs are tied to recreational measures such as possession limits, fish size restrictions, and open/closed seasons. These measures are adjusted as needed to allow harvest to meet but not exceed the RHL. Depending on the magnitude of the increase, an increased recreational allocation may not allow for liberalized recreational management measures compared to recent years in all cases. In some cases, recreational restrictions would still be needed if the allocation increase is not enough to account for recent increases in the MRIP harvest estimates.

Liberalizing or restricting recreational measures can impact angler access to all three species. Increased access could take the form of more fish to take home (under higher possession limits or lower minimum fish sizes) and more opportunities to target these species (under longer open seasons), while decreased access could mean the ability to retain fewer fish and reduced opportunities to target these species. This can affect angler satisfaction, revenues for for-hire businesses (e.g., by impacting demand for for-hire trips), and revenues for support businesses such as bait and tackle shops.

At the community level, these impacts may be greatest for communities with or near recreational fishing sites, communities where for-hire businesses are based, and communities with tourism that is impacted by recreational fishing.

Aside from the no action/status quo alternatives, all the alternatives for all three species would result in reduced allocation to the commercial sector, which is expected to result in lower commercial quotas than the current allocations. The commercial sector may experience a loss in revenue due to corresponding lower quotas and a reduction in potential landings of summer flounder and black sea bass. For scup, this will depend on the degree of the decrease in the quota as the commercial scup quota has not been fully harvested since 2007 due to other factors such as market demand. For all three species, the loss in revenue associated with the reduction in quota is not expected to be linear, as the relationship between price and volume landed in the fishery is not linear and is variable by species. Other factors such as variation in costs can also affect revenue. Some negative impacts associated with quota reductions might be partially offset by the potential for increased prices paid by dealers if decreased quotas result in decreased supply. However, the degree to which this happens depends on the relationship between demand and price.

Impacts from a reduction in commercial quota will not be felt equally across all commercial industry participants. The coastwide commercial quota is divided into state quotas for summer flounder and black sea bass, and seasonal quota periods for scup. Of the three scup quota periods, only the summer period quota is further allocated among states. Some states fully utilize their quota year after year, while other states tend to underutilize their quota. Commercial fishermen³ from states that fully utilize quota are more likely to experience loss in revenue, restrictive trip limits, and seasonal closures to account for the reduced commercial quota. States that have historically underutilized their quota may still be impacted in the medium- to long-term as reduced access to quota may inhibit the ability for market expansion in the future. These states could also be impacted in the near-term depending on the magnitude of allocation reduction. If the commercial allocation is substantially reduced, quotas in some states may drop below what is currently being utilized.

Lower commercial quotas resulting from lower allocations could result in lower trip limits and shorter seasons. Lower trip limits can incentivize high-grading whereby smaller fish are discarded to allow for more landings of larger fish that can fetch a higher price per pound. Shorter seasons could result in market instability through greater fluctuations in price, as well as “race to fish” conditions if seasons are shortened substantially. A reduction in commercial quotas would not just impact commercial fishermen, it would also reduce the availability of these species to consumers. Changes in commercial allocation of these three species also affects the economic health of communities with notable participation in these commercial fisheries through employment in the harvesting, processing, distribution, and retail aspects of the commercial fisheries. The scale of the impacts will depend on the scale of the change and the degree of local economic dependence on these commercial fisheries.

There are also impacts for both sectors associated with switching from a landings-based allocation (currently implemented for summer flounder and black sea bass) to a catch-based allocation (currently implemented for scup). It could be perceived as a benefit that the catch and landings limits for each sector can be calculated independently from each other under a catch-based allocation. As described in more detail in Appendix A, under a catch-based allocation, changes in landings and dead discards in one sector do not influence the other sector’s allocation as the entire ABC is always split among the sectors based on the allocation defined in the FMP, regardless of recent trends in landings and discards by sector. In theory, this can allow each sector to see the

³ The term fishermen applies to all people who fish, regardless of gender.

benefits of a reduction in their own dead discards to a greater extent than under a landings-based allocation. Under a catch-based allocation, a reduction in dead discards in one sector can result in an increase in that sector's landings limit in a future year. This was part of the rationale for implementing the current catch-based allocation for scup as it was expected to incentivize a reduction in commercial dead discards, which were of concern during development of Amendment 8 when the commercial/recreational scup allocations were first developed. Under a landings-based allocation, changes in landings and dead discards in one sector can influence the catch and landings limits in both sectors; therefore, the benefits of a reduction in dead discards (or the negative impacts of an increase in dead discards) in one sector can also be felt by the other sector.

Under all alternatives considered in this action, the commercial and recreational sectors will continue to be held separately accountable for overages of their catch and landings limits. There will be no changes to the accountability measures for either sector.⁴

Biological Impacts to Summer Flounder, Scup, and Black Sea Bass Stocks

As described above, all but the no action/status quo alternatives would reduce the commercial allocations, which would in turn result in lower commercial quotas than the no action/status quo alternatives.

As described in more detail in the species-specific sections below, some alternatives which would increase the recreational allocation may still require additional restrictions in the recreational fisheries compared to the measures used in recent years due to the mismatch between the revised MRIP data and the RHLs which could result from the allocations under many alternatives.

Depending on the scale of the change, a decrease in the commercial quota or additional restrictions on the recreational fishery could lead to increased regulatory discards of these species compared to recent levels. Actual changes in discards will depend on many factors. For example, fishing behavior in both sectors is influenced by many factors in addition to the regulations (e.g., weather, availability of other target species, market demand). Discards are also influenced by availability of each species, both overall abundance and by size class. For example, high availability of fish smaller than the minimum size limit can lead to high regulatory discards. Lower availability of legal-sized fish can lead to decreased discards. For these reasons, it is challenging to predict future discards based on changes in allocations.

In all cases, total dead catch (i.e., landings and dead discards) will continue to be constrained by the overall ABC, which is set based on the best scientific information available and is intended to prevent overfishing. In this way, none of the alternatives are expected to change patterns in landings, discards, or fishing effort in such a way that they negatively impact stock status for any of the three species.

Landings and discards in the commercial and recreational sectors are monitored and estimated in different ways. A preliminary analysis taking into account the different levels of precision of the estimates of landings and dead discards in each sector for all three species suggests that the risk of exceeding the ABC does not vary greatly under a wide range of different proportions of total dead catch from each sector. This suggests that changes in the commercial/recreational allocation,

⁴ A summary of the current accountability measures for summer flounder, scup, and black sea bass can be found at: https://www.mafmc.org/s/AMs-description_SF_scup-BSB_Dec2020.pdf.

especially changes within the range currently under consideration, may not have notably different impacts on the risk of exceeding the ABC.

4.2.2 Summer Flounder Allocation Impacts

Many stakeholders across regions and fishing modes view the summer flounder recreational minimum size and bag limit to be overly restrictive. Shore-based anglers in particular are concerned about the high minimum size. Depending on the alternative selected and annual considerations, an increase in allocation to the recreational sector may allow for a liberalization of these measures and could increase access to anglers. A reduction in the minimum size limit may be particularly impactful to those who fish from shore and typically encounter smaller fish. Allowing more fish to be retained increases angler satisfaction and provides greater access to fish to bring home to eat.

Table 5 compares example quotas and RHLs under each allocation alternative using the 2020 ABC (see Appendix C for methodology) to the actual quota and RHL implemented in 2020. All alternatives represent an increase in allocation to the recreational sector relative to the no action/status quo alternative (1a-4), and therefore an increase in the RHL. Likewise, each alternative other than the status quo alternative represents a decrease in allocation and resulting commercial quota for the commercial sector. Relative to the actual 2020 limits, example limits would range from no change (under the status quo alternative 1a-4) to a 34% decrease in the commercial quota and 43% increase in the RHL (under alternative 1a-7). Again, these limits are examples. Actual future quotas and RHLs are likely to differ from these examples based on future ABCs, discard assumptions, and other considerations.

Figure 1 compares the example quotas and RHLs (using the 2020 ABC, Table 5) to commercial and recreational landings for summer flounder from 2004 through 2019. Since 2004, landings in each sector have varied with annually varying quotas and RHLs and other factors. In most years since 2004, commercial landings have been above the example commercial quotas, particularly under alternatives 1a-1, 1a-2, 1a-3, 1a-6, and 1a-7. This indicates that if the overall ABC remains similar to 2020, reduced commercial landings may be required relative to most recent years. However, most example quotas are above commercial landings for 2016-2018, indicating that relative to these more recent years, commercial landings may not need to be cut, depending on future ABCs.

For the recreational fishery, harvest in most years since 2004 has been above the example RHLs using the 2020 ABC. However, the example RHLs under most alternatives are higher than recreational harvest during 2017-2019, meaning that recreational measures may be able to be liberalized relative to these years if ABCs remain similar to 2020 levels, depending on actual RHLs and current and future harvest trends.

As previously stated, the summer flounder commercial quota is further allocated among the states based on allocation percentages defined in the FMP. Starting January 1, 2021, as the result of Amendment 21 to the FMP,⁵ the commercial allocations of the summer flounder quota among the states will vary based on the overall coastwide commercial quota amount. When the quota is below 9.55 million pounds, it will be allocated among states based on the state allocations that have been in place since Amendment 2 (1993). Any surplus quota above 9.55 million pounds will be allocated

⁵ See <https://www.mafmc.org/actions/summer-flounder-amendment> for additional information on this amendment.

differently. As shown in Table 5, some of the example quotas (using the 2020 ABC as an example for future quotas under recent biomass levels) would be above that threshold while some would fall below. Therefore, some of these alternatives could have implications for how the summer flounder quota is allocated among states.

Along with summer flounder commercial landings potentially varying under the various allocation alternatives, ex-vessel prices may also change (Figure 2). Using the equation in Figure 2, prices can be estimated under different landed quantities. For example, assuming full utilization of the example commercial quota in alternative 1a-7 (7.65 million pounds under a 25.03 million pound ABC), the average ex-vessel price is predicted to be \$2.75 per pound and would yield \$21.0 million in total ex-vessel revenue (both in 2019 dollars). If the same process is followed for the alternative 1a-4 example quota (11.10 million pounds), the average ex-vessel price would fall to \$1.82 per pound and revenues would decrease to \$20.2 million, despite the higher quota. These are rough estimates, and price is influenced by many other factors aside from landings, such as changes in consumer preferences or product substitution. This simplified example does offer some limited support that full utilization of the quota under the highest commercial quota alternative may not maximize fishery-wide revenues.

The Council funded a study consisting of an economic model to evaluate the current 60/40 summer flounder landings allocation. The model, developed by Dr. Kurt Schnier (University of California, Merced) and Dr. Rob Hicks (College of William & Mary), aimed to determine which allocations would maximize marginal economic benefits (the marginal value to each sector of an additional pound of summer flounder allocation at a given allocation) to the commercial and recreational sectors. The original model was peer reviewed in November 2016 with a final report completed in 2017.⁶ In 2019 and 2020, the model was updated with the revised MRIP estimates released in 2018, as well as more recent commercial fishery data. The results of the updated model suggest that the existing 60/40 commercial/recreational allocation is not suboptimal from an economic efficiency perspective. However, it also suggested that modest allocation changes in either direction would not likely lower the economic benefits received from both sectors of the fishery combined.⁷ Using the new recreational data, the value of the fishery to the recreational sector increased relative to the results of the prior report. The point estimate of the recreational sector's marginal willingness to pay is higher and would potentially support higher recreational allocations; however, the confidence intervals for the recreational and commercial sectors' willingness to pay estimates have substantial overlap due to high uncertainty in these estimates, particularly for the recreational sector. This means that due to data limitations, more concrete guidance about optimal allocations could not be generated due to the inability to more precisely estimate the recreational sector's value.

⁶ The final 2017 report is available at: https://www.mafmc.org/s/Hicks-Schnier-Summer_flounder_allocation_report_final_4_11_2017.pdf.

⁷ The updated report (December 2020) is available at: https://www.mafmc.org/s/Hicks-Schnier_Summer_Flounder_allocation_report_UPDATE-Dec-2020.pdf.

Table 5: Example commercial quotas and RHLs for each allocation alternative under the 2020 ABC (25.03 million pounds) and the assumptions outlined in Appendix C, with comparison to the 2020 implemented limits. Actual future limits will vary based on future ABCs and discard assumptions.

Alternative	1a-1	1a-2	1a-3	1a-4 ^a	1a-5	1a-6	1a-7
	Catch-Based			Landings-Based			
Com. allocation	44%	43%	40%	60%	55%	45%	41%
Rec. allocation	56%	57%	60%	40%	45%	55%	59%
Example commercial quota	8.79	8.57	7.92	11.53^b	10.20	8.38	7.65
% Difference from 2020 commercial quota	-24%	-26%	-31%	0%	-12%	-27%	-34%
Example RHL	10.24	10.47	11.15	7.69^b	8.34	10.25	11.02
% Difference from 2020 RHL	33%	36%	45%	0%	8%	33%	43%

^a Alternative 1a-4 is the no action/status quo alternative for summer flounder (i.e., the current commercial/recreational allocations).

^b The actual implemented commercial quota and RHL for 2020 are shown under Alternative 1a-4 (no action/status quo).

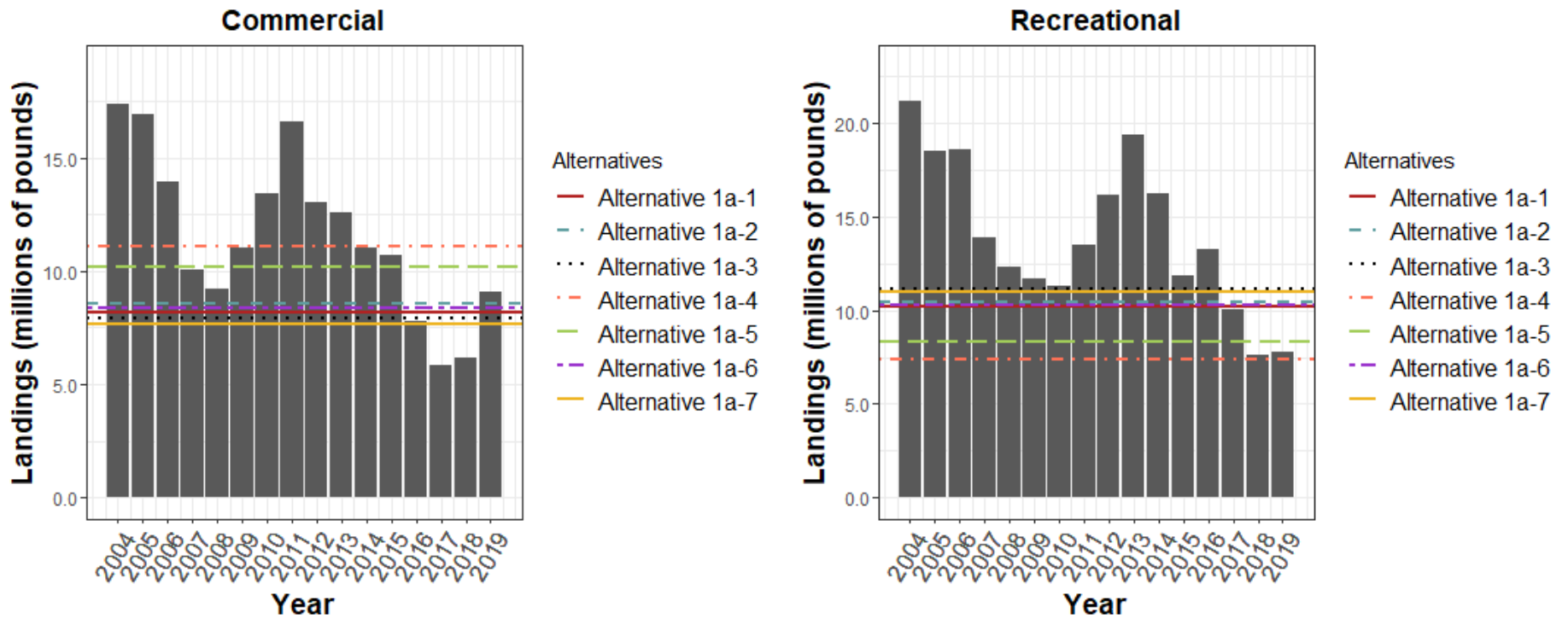

It is important to note that all alternatives under consideration are assuming that the ABC is similar to the 2020 ABC for summer flounder.

Figure 1: Recent (2004-2019) commercial and recreational summer flounder landings with comparison to example commercial quotas and RHLs developed using the 2020 ABC (see Appendix C for methodology).

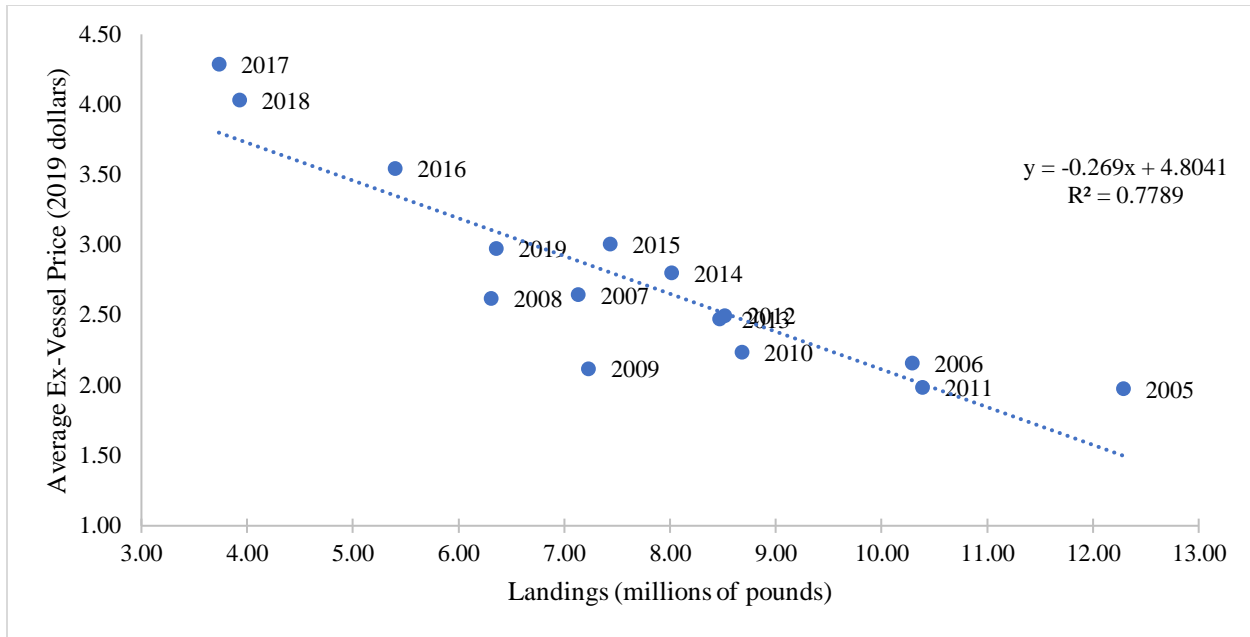

Figure 2: Commercial summer flounder landings and average ex-vessel prices, 2005-2019, in 2019 dollars. Source: NEFSC Social Sciences Branch, personal communication.

4.2.3 Scup Allocation Impacts

Table 6 compares example quotas and RHLs under each allocation alternative using the 2020 ABC (see Appendix C for methodology) to the actual quota and RHL implemented in 2020. Relative to the actual 2020 limits, example limits would range from no change (under the status quo/no action alternative 1b-1) to a 33% decrease in the commercial quota and 127% increase in the RHL (under alternative 1b-7). Actual future quotas and RHLs are likely to differ from these examples based on future ABCs, discard assumptions, and other considerations. Figure 3 compares the example quotas and RHLs (using the 2020 ABC, Table 5) to commercial and recreational landings for scup from 2004 through 2019.

Under the no action/status quo alternative for scup (alternative 1b-1), restrictions to the bag limit, minimum size, and/or season would need to be implemented to prevent exceeding the RHL. This is because the revised MRIP harvest estimates for recent years are notably higher than the RHLs that result from the current allocation (assuming recent ABC levels; Figure 3). Alternatives 1b-2 through 1b-7 would increase the recreational allocation. Alternative 1b-7 results in the highest example RHL, and is the only alternative that projects an example RHL that is higher than 2004-2019 recreational harvest (Figure 3). Therefore, alternative 1b-7 would provide the most benefit to the recreational sector in the form of higher angler satisfaction, greater economic opportunity, more revenue to the for-hire sector compared to the other allocation alternatives. Recreational harvest in recent years is variable as shown in Figure 3, however alternatives 1b-3 through 1b-6 have the potential to allow for harvest at similar levels to recent years.

Alternatives 1b-2 through 1b-7 include lower commercial allocations than the no action/status quo alternative (1b-1). The commercial sector has not fully utilized its quota since 2007 so a decrease in allocation would not necessarily lead to a decrease in commercial landings or revenues compared to recent levels. Commercial landings from 2004 through 2010 and 2018 through 2019

fall below the example quotas shown in Figure 3 for all alternatives. However, alternatives 1b-2 through 1b-7 may limit the potential for market expansion and future increases in landings and ex-vessel revenue compared to the no action/status quo alternative (1b-1).

In 2018, the scup stock was at 198% of the biomass target level and trending down to the target. The compounding effects of reductions in allocation to the commercial sector combined with a reduction in the overall ABC could result in lower commercial quotas in the future. The reduction in commercial quota under alternatives 1b-2 through 1b-7 may not constrain harvest on a coastwide basis but may negatively impact commercial industry members in states that fully utilize their state quota during the summer scup quota period. Impacts may be felt more equally across states in the winter 1 and 2 period scup fishery with the coastwide trip limit.

Ex-vessel prices may change if changes in the allocation result in changes in commercial landings (Figure 4). Using the equation in Figure 4, prices can be estimated under different landed quantities. For example, assuming full utilization of the example commercial quota in alternative 1b-7 (14.81 million pounds under a 35.77 million pound ABC), the average ex-vessel price is predicted to be \$0.54 per pound and would yield \$7.9 million in total ex-vessel revenue. Full utilization of the quota under some of the higher quota alternatives, such as 1b-1, would decrease revenues following these methods. Average scup landings over the last three years are 14.20 million pounds, meaning full utilization of the quota would appear unlikely under a number of the allocation alternatives and the current ABC. Based on the price responses to changes in quantity, achieving full utilization of the quota may not be economically desirable for the commercial scup fishery as a whole.

Table 6: Example commercial quotas and RHLs for each allocation alternative under the 2020 ABC (35.77 million pounds) and the assumptions outlined in Appendix C, with comparison to the 2020 implemented limits. Actual future limits will vary based on future ABCs and discard assumptions.

Alternative	1b-1 ^a	1b-2	1b-3	1b-4	1b-5	1b-6	1b-7
	Catch-Based				Landings-Based		
Com. allocation	78%	65%	61%	59%	57%	56%	50%
Rec. allocation	22%	35%	39%	41%	43%	44%	50%
Example commercial quota	22.23 ^b	16.90	15.92	15.44	16.85	16.56	14.81
% Difference from 2020 commercial quota	0%	-24%	-28%	-31%	-24%	-26%	-33%
Example RHL	6.51 ^b	11.04	12.37	13.04	12.71	13.01	14.81
% Difference from 2020 RHL	0%	70%	90%	100%	95%	100%	127%

^a Alternative 1b-1 is the no action/status quo alternative for scup (i.e., the current commercial/recreational allocations).

^b The actual implemented commercial quota and RHL for 2020 are shown under Alternative 1b-1 (no action/status quo).

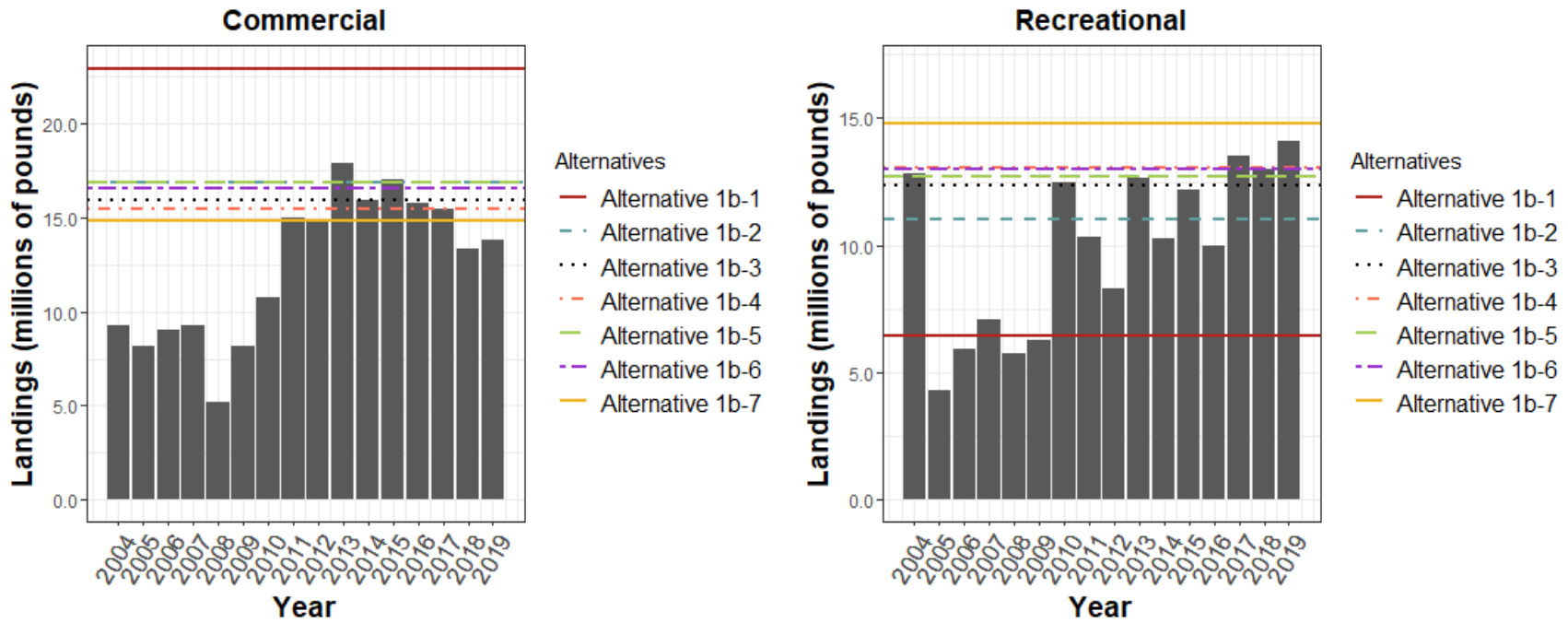

It is important to note that all alternatives under consideration are assuming that the ABC is similar to the 2020 ABC for scup.

Figure 3: Recent (2004-2019) commercial and recreational scup landings with comparison to example commercial quotas and RHLs developed using the 2020 ABC (see Appendix C for methodology).

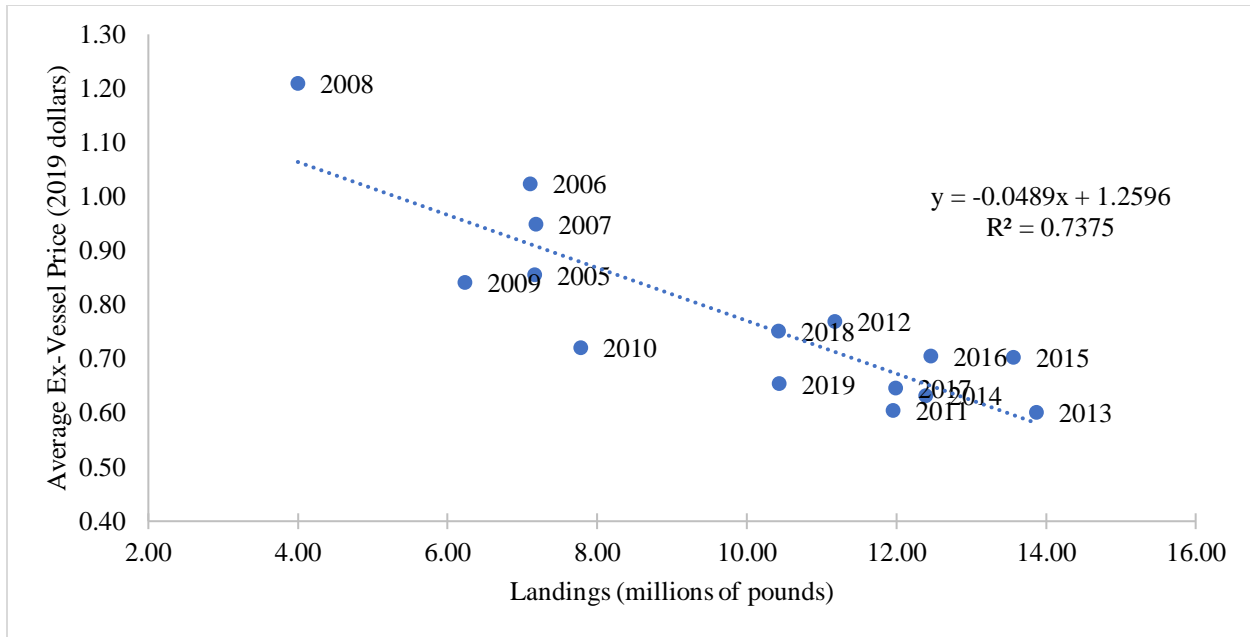

Figure 4. Commercial scup landings and average ex-vessel prices, 2005-2019, in 2019 dollars. Source: NEFSC Social Sciences Branch, personal communication.

4.2.4 Black Sea Bass Allocation Impacts

All black sea bass alternatives, with the exception of the no action/status quo alternative (1c-4) would increase the recreational allocation and decrease the commercial allocation. Table 7 compares example quotas and RHLs under each allocation alternative using the 2020 ABC (see Appendix C for methodology) to the actual quota and RHL implemented in 2020. Relative to the actual 2020 limits, example limits would range from no change (under the status quo/no action alternative 1c-4) to a 53% decrease in the commercial quota and 60% increase in the RHL (under alternative 1c-7). Again, these limits are examples. Actual future quotas and RHLs are likely to differ from these examples based on future ABCs, discard assumptions, and other considerations.

Figure 5 compares the example black sea bass quotas and RHLs (using the 2020 ABC, Table 7) to commercial and recreational landings from 2004 through 2019. Throughout this time period, commercial and recreational landings varied with changes in the landings limits, changes in black sea bass availability, and other factors. It is important to note that all example quotas and RHLs assume that the ABC is similar to the 2020 ABC, which was higher than any previous ABC for black sea bass. In all years shown in Figure 5, the commercial and recreational fisheries operated under landings limits that were set based on ABCs lower than the 2020 ABC.

As shown in Figure 5, commercial landings were below the example quotas under alternatives 1c-4 and 1c-5 during 2004-2019, largely because the fishery was constrained by much lower quotas during those years. The other alternatives result in example quotas that are lower than commercial landings in 2 (alternatives 1c-1 and 1c-6), 4 (alternative 1c-2), or 6 (alternatives 1c-3 and 1c-7) of the 16 years during 2004-2019. The highest commercial landings during this time period occurred during 2017-2019. Therefore, if future ABCs are similar to the 2020 ABC, commercial landings may need to be restricted compared to recent years (i.e., 2017-2019) under all but alternatives 1c-4 and 1c-5. The greatest restrictions would be necessary under alternatives 1c-3 and 1c-7 (Figure

5). Reductions in commercial landings could lead to reduced revenues and negative socioeconomic impacts for commercial fishery participants and support businesses.

Ex-vessel prices for commercial landings may also change in response to the different potential quota levels under each alternative (Figure 6). Using the equation in Figure 3, prices can be estimated under different landed quantities. For example, assuming full utilization of the example commercial quota in alternative 1c-7 (2.61 million pounds under a 15.07 million pound ABC) the average ex-vessel price is estimated to be \$3.25 per pound and would yield \$8.5 million in ex-vessel revenue. If the same process is followed for the alternative 1c-4 example quota (5.43 million pounds), the average ex-vessel price would fall to \$2.48 per pound. Despite this reduced average price, revenues would continue to increase to \$13.5 million. These are rough estimates, and price is influenced by many other factors aside from landings, such as changes in consumer preferences or product substitution. These results, however, do suggest that black sea bass commercial revenues would increase under higher quotas with full utilization.

As shown in Figure 5, the example RHLs under all alternatives are lower than recreational harvest in at least 3 of the 16 years from 2004-2019. Alternative 1c-4 results in the lowest example RHL, which is lower than harvest during 9 of the 16 years from 2004-2019, followed by alternative 1c-5, which results in an example RHL which is lower than harvest in 8 of the 16 years. However, when considering only 2018-2019, only alternatives 1c-4 and 1c-5 result in example RHLs that are lower than harvest in those years. Therefore, if future ABCs are similar to the 2020 ABC, and depending on future considerations about expected harvest, recreational harvest may not need to be notably restricted compared to recent years (specifically, 2018-2019), under all but alternatives except 1c-4 and 1c-5. Alternatives 1c-4 and 1c-5 could require notable restrictions for the recreational fishery, compared to recent years. Figure 5 suggests that it is not likely that any of the alternatives would allow for increased harvest or notable liberalizations in recreational management measures compared to recent years. Depending on the alternative and annual considerations, all but alternatives 1c-4 and 1c-5 could allow for roughly status quo recreational management measures, or they could require slight to moderate restrictions. As previously stated, more restrictive management measures would be expected to have negative socioeconomic impacts for the recreational sector due to reduced angler satisfaction, reduced demand for for-hire trips, and reduced revenues for for-hire businesses and other recreational fishery support businesses.

Based on the information shown in Figure 5, none of the alternatives would be expected to prevent a need for restrictions in both the recreational and commercial sectors, based on the comparison of example quotas and RHLs against recent landings shown in Figure 5. As previously stated, none of the alternatives are expected to allow for increased recreational harvest compared to recent levels if the ABC remains similar to 2020. The alternatives which, depending on annual considerations, may allow for close to status quo recreational harvest (alternatives 1c-1 through 1c-4, and 1c-6 and 1c-7) would require varying levels of reduction in commercial landings, depending on the alternative, (Figure 5).

Table 7: Example commercial quotas and RHLs under each allocation alternative using the 2020 ABC (15.07 million pounds) and the assumptions outlined in Appendix C, with comparison to the 2020 limits. Actual future limits will vary based on future ABCs and discard assumptions.

Alternative	1c-1	1c-2	1c-3	1c-4 ^a	1c-5	1c-6	1c-7
	Catch-Based			Landings-Based			
Com. allocation	32%	28%	24%	49%	45%	29%	22%
Rec. allocation	68%	72%	76%	51%	55%	71%	78%
Example commercial quota	3.31	2.99	2.66	5.58^b	5.04	3.38	2.61
% Difference from 2020 commercial quota	-41%	-46%	-52%	0%	-10%	-39%	-53%
Example RHL	8.16	8.65	9.14	5.81^b	6.15	8.28	9.27
% Difference from 2020 RHL	40%	49%	57%	0%	6%	43%	60%

^a Alternative 1c-4 is the no action/status quo alternative for black sea bass (i.e., the current commercial/recreational allocations).

^b The actual implemented commercial quota and RHL for 2020 are shown under Alternative 1c-4 (no action/status quo).

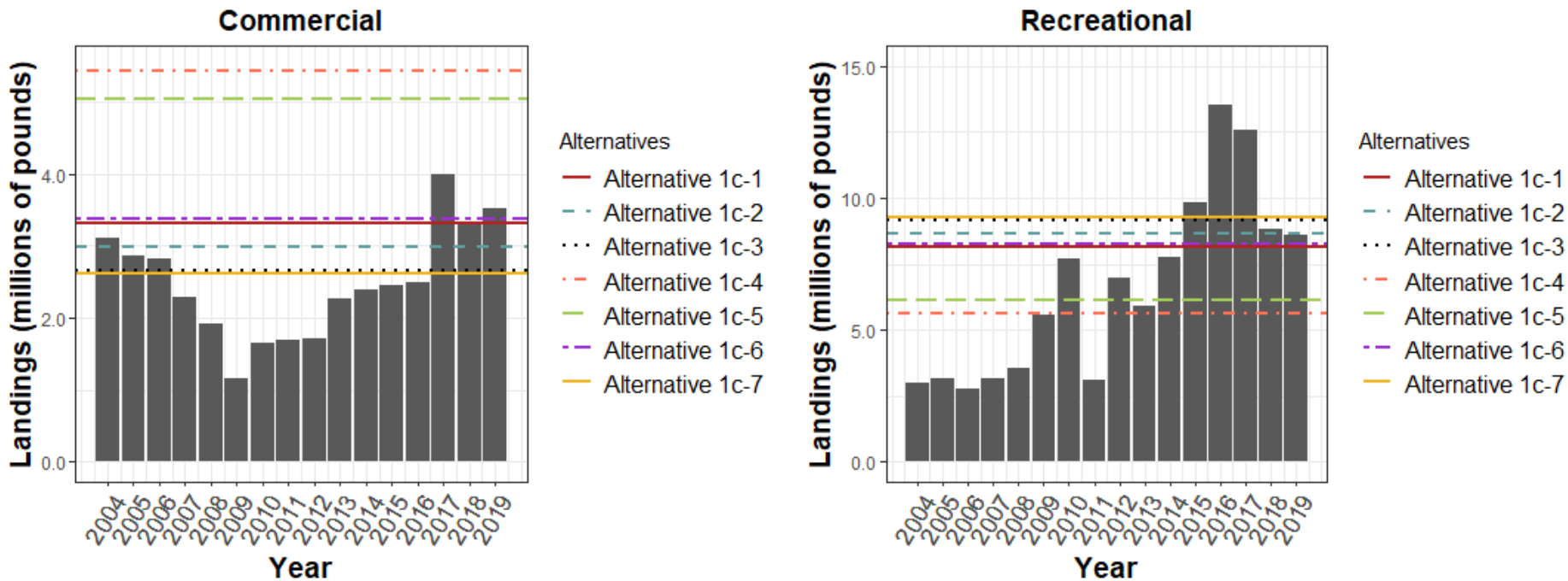

It is important to note that all alternatives under consideration are assuming that the ABC is similar to the 2020 ABC, which was higher than any previous ABC for black sea bass.

Figure 5: Recent (2004-2019) commercial and recreational black sea bass landings with comparison to example commercial quotas and RHLs developed using the 2020 ABC (see Appendix C for methodology).

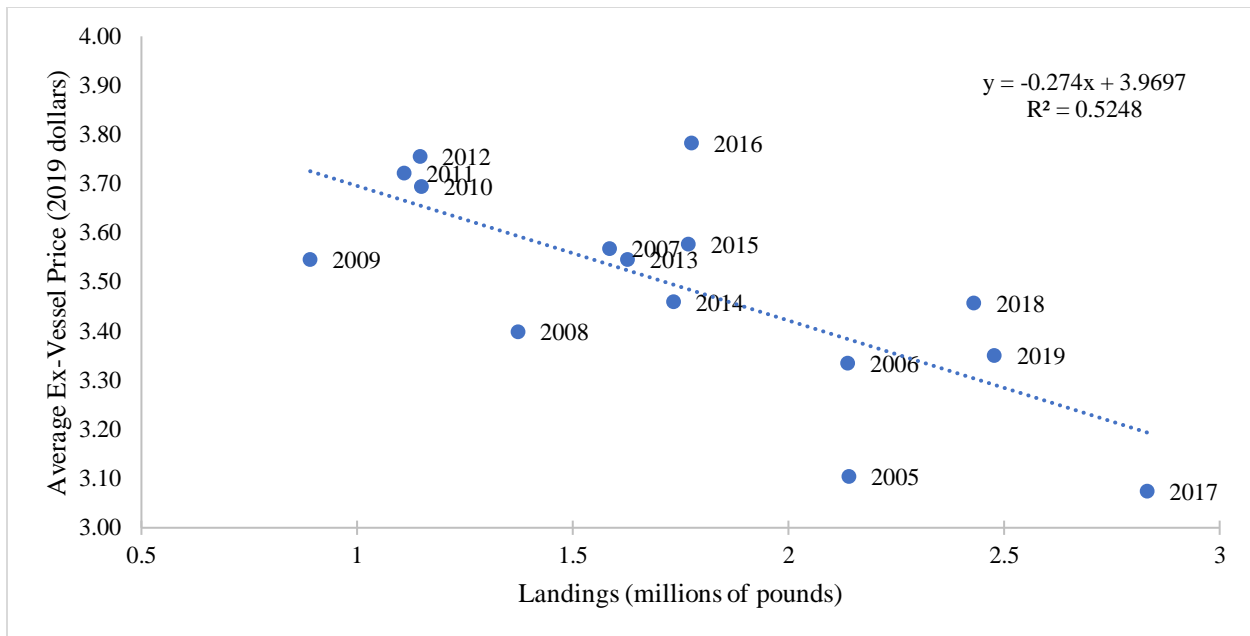

Figure 6. Commercial black sea bass landings and average ex-vessel prices, 2005-2019, in 2019 dollars. Source: NEFSC Social Sciences Branch, personal communication.

4.3 Allocation Change Phase-In

4.3.1 Allocation Change Phase-In Alternatives

The alternatives listed in Table 8 consider if any changes to the allocation percentages considered through alternative sets 1a, 1b, and 1c should occur in a single year (alternative 1d-1, no phase in) or if the change should be spread over 2, 3, or 5 years (alternatives 1d-2 through 1d-4). The Council and Board agreed that 5 years is a reasonable maximum phase-in time frame as longer transition periods may not adequately address the issue an allocation change is attempting to address. The choice of whether to use a phase-in approach, and the length of the phase-in, may depend on the magnitude of allocation change proposed. A phase-in period may not be desired if the overall allocation change is relatively small. Larger allocation changes may be less disruptive to fishing communities if they are phased in over several years.

These phase-in alternatives could apply to any of the three species. The Council and Board may choose to apply different phase-in alternatives (including no phase-in) to each species if desired.

Table 8: Allocation change phase-in alternatives.

Phase-In Alternatives
1d-1: No phase-in
1d-2: Allocation change evenly spread over 2 years
1d-3: Allocation change evenly spread over 3 years
1d-4: Allocation change evenly spread over 5 years

4.3.2 Impacts of Allocation Change Phase-In Alternatives

The biological, social, and economic impacts of the phase-in alternatives are dependent on two things: 1) the difference between the status quo allocation percentage and the allocation percentage

selected, and 2) the duration of the phase-in period. Based on the range of allocation percentages across the three species (Section 4.1), the commercial and recreational sector allocations could shift by as much as 13.5% per year, or as little as 0.8% per year under the above phase-in timeframes of 2-5 years. Sections 4.3.2.1 through 4.3.2.3 describe the associated percent shifts per year for each species, and the impacts of these phase-in approaches.

Both catch- and landings-based allocation alternatives are being considered for all three species. As previously stated, summer flounder and black sea bass are currently managed under a landings-based allocation and scup is currently managed under a catch-based allocation. It is straightforward to calculate the annual percent shift in allocation under each phase-in alternative if the allocation remains landings-based for summer flounder and black sea bass or catch-based for scup.

The phase-in transition is more complicated when transitioning from a landings-based to a catch-based allocation or vice versa. Under a landings-based allocation, the division of expected dead discards to each sector is typically calculated using a moving average of recent trends. As a result, under a landings-based allocation, the percentage of the ABC (landings + dead discards) assigned to each sector typically varies from year to year and usually does not match the landings-based allocation percent. To illustrate this, the 2021 percent split of landings, dead discards, and sector ACLs for each species are shown in Table 9. As described below, when transitioning from a landings-based to a catch-based allocation or vice versa, the total and annual phase-in amounts should not be calculated starting from the existing FMP allocation, as the actual split of catch does not match the landings-based allocation for summer flounder and black sea bass, and the actual split of landings does not match the catch-based allocation for scup. The phase-in amounts for each alternative can instead be calculated by using the 2021 measures as a starting point since these are the implemented measures that the transition would be away from. This includes the actual division of catch (for transition to a catch-based allocation) or landings (for transition to a landings-based allocation) in 2021. Additional details for each species are discussed below.

Table 9: The currently implemented recreational/commercial split for total landings, dead discards, and total dead catch for 2021 specifications. The current FMP-specified allocations for each species are highlighted in yellow.

Currently Landings-Based Allocations						
	Comm. % of TAL (allocation)	Rec. % of TAL (allocation)	Expected comm. % of discards in 2021	Expected rec. % of discards in 2021	Comm. ACL % of ABC in 2021	Rec. ACL % of ABC in 2021
Summer flounder	60	40	34	66	54	46
Black sea bass	49	51	68	32	55	45
Currently Catch-Based Allocation						
	Comm. % of TAL in 2021	Rec. % of TAL in 2021	Expected comm. % of discards in 2021	Expected rec. % of discards in 2021	Comm. ACL % of ABC (allocation)	Rec. ACL % of ABC (allocation)
Scup	74	23	81	19	78	22

NEFSC Social Sciences Branch crew survey results (Table 10) suggest that while a limited number of crew from the summer flounder, scup, and black sea bass fisheries were surveyed, the majority of those surveyed agreed that it was hard to keep up with changes in regulations. A phase-in approach to reallocation would still involve regulatory change, though limiting year-to-year change in allocation could possibly make it easier for industry members to adapt to these changes. However, phase-in approaches may also require more frequent changes in management measures such as open seasons and possession limits during the phase-in period. Therefore, consideration should be given to balancing regulatory stability and economic stability.

Table 10. NEFSC Social Sciences Branch Crew Survey results for reactions to the statement “the rules and regulations change so quickly it is hard to keep up.” Results presented for crew primarily involved in the summer flounder, scup, and black sea bass fisheries over the 2012-2013 survey, 2018-2019 survey, and the combined results.

Survey Wave	2012-13	2018-19	Total
Strongly agree	3 (27%)	10 (45%)	13 (39%)
Agree	4 (36%)	7 (32%)	11 (33%)
Neutral	1 (9%)	2 (9%)	3 (9%)
Disagree	3 (27%)	3 (14%)	6 (18%)
Strongly disagree	0 (0%)	0 (0%)	0 (0%)
Total	11 (100%)	22 (100%)	33 100%)

4.3.2.1 Summer Flounder Phase-In Impacts

If the summer flounder allocation is modified but a landings-based allocation is maintained (alternatives 1a-5 through 1a-7), the annual percent shift amounts are easily calculated by taking the difference between the starting and ending allocations for each sector and evenly dividing that percentage among the 2, 3, or 5 years of phase-in depending on the phase-in alternative (Table 11).

Under a transition from a landings-based to a catch-based allocation (alternatives 1a-1 through 1a-3), dead discards would first need to be incorporated into the current baseline to determine the total and annual percent shift. Any allocation changes adopted are meant to take effect starting in 2022; therefore, the specifications for 2021 can serve as this baseline for the current split of catch by sector. Specifically, the percentage of the ABC that each sector will receive in 2021 as a sector ACL is used as the starting point for calculating transition percentages below.

For summer flounder, in 2021, the commercial ACL represents 54% of the ABC and the recreational ACL represents 46% of the ABC (Table 9). From these starting percentages, the total amount of catch-based allocation shift can be calculated, and evenly divided among the 2, 3, or 5 years depending on the phase-in alternative (Table 11).

Table 11: Percent shift in summer flounder allocation per year for 2, 3, and 5 year phase-in options for all summer flounder allocation change alternatives.

Catch-Based Alternatives	Total amount of allocation percent shift needed^a	1d-2: 2 year phase-in	1d-3: 3 year phase-in	1d-4: 5 year phase -in
1a-1: 44% commercial, 56% recreational	10%	5% shift per year	3.3% shift per year	2% shift per year
1a-2: 43% commercial, 57% recreational	11%	5.5% shift per year	3.7% shift per year	2.2% shift per year
1a-3: 40% commercial, 60% recreational	14%	7% shift per year	4.7% shift per year	2.8% shift per year
Landings-Based Alternatives	Total amount of allocation percent shift needed^b	1d-2: 2 year phase-in	1d-3: 3 year phase-in	1d-4: 5 year phase -in
1a-4 (status quo): 60% commercial, 40% recreational	0%	N/A	N/A	N/A
1a-5: 55% commercial, 45% recreational	5%	2.5% shift per year	1.7% shift per year	1% shift per year
1a-6: 45% commercial, 55% recreational	15%	7.5% shift per year	5% shift per year	3% shift per year
1a-7: 41% commercial, 59% recreational	19%	9.5% shift per year	6.3% shift per year	3.8% shift per year

^a For catch-based alternatives, the starting point for this calculation is the current (2021) split of the sector-specific ACLs (which incorporates dead discards) instead of the landings limit allocation. Here, this shift is calculated by starting from the 2021 specifications which includes a commercial ACL that is 54% of the ABC, and a recreational ACL that is 46% of the ABC (Table 9).

^b For landings-based alternatives, the starting point for this calculation is the specified landings-based allocation (60% commercial/40% recreational). This does not account for dead discards, which would continue to be split using different methods with the resulting percentages varying depending on the year.

Across all summer flounder alternatives, the total allocation shift (if allocations are modified) from the commercial to the recreational fishery would range from 5-19% from the current allocations, and the annual phase-in would range from 1.7% per year to 9.5% per year depending on the allocation change and the phase-in alternative selected (Table 11).

As described in Section 4.2, a decline in commercial allocation is expected to lead to a decline in landings and revenue, especially in states where the commercial allocation is fully utilized. The potential decline in landings may result in higher ex-vessel prices due to a price/volume relationship, potentially tempering declines in ex-vessel revenue. The recreational sector for summer flounder is expected to experience positive social and economic impacts under any of the allocation changes proposed in alternatives 1a-1 through 1a-7 (with the exception of the no action/status quo alternative 1a-4). However, the positive impacts may be partially offset by an inability to meaningfully liberalize measures under a higher allocation given the transition to revised MRIP estimates. The phase-in option selected would affect how quickly these negative and positive impacts are felt by each sector, which could influence how well sector participants are able to adapt to any changes.

For the commercial industry, a more abrupt transition to a revised allocation (alternative 1d-1 and to a lesser extent 1d-2) may result in a sudden loss of income and jobs due to a more sudden drop in revenue in the commercial fishery. Commercial sector participants who are highly dependent on summer flounder may have more difficulty remaining in business while evaluating options for maintaining revenue streams, such as shifting effort to other target species. Alternatives 1d-3 and 1d-4 (a 3- or 5-year phase-in, respectively), would provide a longer transition time for the commercial industry to adapt to loss of fishing opportunity for summer flounder. This could allow for a smoother transition to modified business models such as diversifying target species.

For the recreational fishery, a more abrupt transition to a revised allocation (alternative 1d-1 and to a lesser extent 1d-2) is expected to have social and economic benefits as this allows for a faster transition to an allocation that supports the recent recreational harvest under the revised MRIP data (Figure 1). This has implications for recreational management measures, which could be liberalized more quickly if a faster transition to a revised allocation occurs. For summer flounder recent recreational harvest under the revised MRIP estimates are at similar levels as recent RHLs, so it is possible that recreational measures could be liberalized in the coming years if allocation to the recreational sector is increased (e.g., Figure 1). However, this is also dependent on future projections of stock biomass, trends in recreational catch and effort, and other factors. If recreational measures can be liberalized, this could result in a decrease in recreational discards. Alternatives 1d-3 and 1d-4 (a 3- or 5-year phase-in, respectively), would provide a longer transition to an increased recreational allocation for summer flounder. This may mean that recreational measures and fishing opportunities could be maintained at current levels for longer, or liberalized more slowly, though it is important to note that possible liberalizations depend on many different factors and are not guaranteed.

4.3.2.2 Scup Phase-In Impacts

The current allocation for scup is catch-based. If the allocation is modified but a catch-based allocation is maintained (alternatives 1b-2 through 1b-4), the annual percent shift amounts are easily calculated by taking the difference between the starting and ending allocations for each sector and evenly dividing that percentage among the 2, 3, or 5 years of phase-in depending on the phase-in alternative (Table 12).

Under a transition from a catch-based to a landings-based allocation (alternatives 1b-5 through 1b-7), dead discards would first need to be separated from the current baseline to determine the total and annual percent allocation shift. Because any allocation changes adopted are meant to take effect starting in 2022, the specifications for 2021 can serve as this baseline for the current split of landings by sector. Specifically, the percentage of the total allowable landings (TAL) that each sector will receive in 2021 as sector landings limits (commercial quota and RHL) is used as the starting point for calculating transition percentages below (Table 9).

For scup, in 2021, the commercial quota represents 77% of the TAL and the RHL represents 23% of the TAL (Table 9). From these starting percentages, the total amount of landings-based allocation shift can be calculated, and evenly divided among the 2, 3, or 5 years depending on the phase-in alternative (Table 12).

Table 12: Percent shift in scup allocation per year for 2, 3, and 5 year phase-in options for all scup allocation change alternatives.

Catch-Based Alternatives	Total amount of allocation percent shift needed^a	1d-2: 2 year phase-in	1d-3: 3 year phase-in	1d-4: 5 year phase -in
1-b1 (status quo): 78% commercial, 22% recreational	0%	N/A	N/A	N/A
1b-2: 65% commercial, 35% recreational	13%	6.5% shift per year	4.3% shift per year	2.6% shift per year
1b-3: 61% commercial, 39% recreational	17%	8.5% shift per year	5.7% shift per year	3.4% shift per year
1b-4: 59% commercial, 41% recreational	19%	9.5% shift per year	6.3% shift per year	3.8% shift per year
Landings-Based Alternatives	Total amount of allocation percent shift needed^b	1d-2: 2 year phase-in	1d-3: 3 year phase-in	1d-4: 5 year phase -in
1b-5: 57% commercial, 43% recreational	20%	10% shift per year	6.7% shift per year	3.4% shift per year
1b-6: 56% commercial, 44% recreational	21%	10.5% shift per year	7% shift per year	4 % shift per year
1b-7: 50% commercial, 50% recreational	27%	13.5% shift per year	9% shift per year	5.4% shift per year

^a For catch-based alternatives, the starting point for this calculation is the FMP-specified allocation percentage (78% commercial/22% recreational).

^b For landings-based alternatives, the starting point for this calculation is the current (2021) split of the sector-specific landings limits (commercial quota and RHL). Here, this shift is calculated by starting from the 2021 specifications which includes a commercial quota that is 77% of the total allowable landings, and an RHL that is 23% of the total allowable landings (Table 9). This does not account for dead discards, which going forward would be split using different methods with the resulting percentages varying depending on the year.

Across all the alternatives for scup, the total allocation shift needed (if allocations are modified) from the commercial to the recreational fishery would range from 13-27% from current allocations, and the annual phase-in would range from 2.6% per year to 13.5% per year depending on the allocation change and the phase-in alternative selected (Table 12).

As described in Section 4.2, depending on the scale of the change, a decline in commercial allocation could lead to loss of revenues from scup or it may not impact revenues as commercial landings have been below the full allowed amount for several years due to market factors. Any potential loss in revenue for fishermen may be partially offset by increased prices paid by dealers if a price/volume relationship impacts prices under lower quotas (Figure 4). The recreational sector is expected to experience positive social and economic impacts under any of the allocation changes proposed in alternatives 1b-1 through 1b-7 (with the exception of the no action/status quo alternative 1b-1). However, the positive impacts may be partially offset by an inability to meaningfully liberalize measures under a higher allocation given the transition to revised MRIP estimates (Figure 3). The phase-in option selected would affect how quickly these negative and positive impacts are felt by each sector, which could influence how well fishery participants are able to adapt to any changes.

For the commercial industry, a more abrupt transition to a revised allocation (alternative 1d-1 and to a lesser extent 1d-2), especially when coupled with a greater total allocation change, may result in a more sudden loss of income and jobs due to a more sudden drop in revenue. Commercial sector participants who are highly dependent on scup may have more difficulty remaining in business while evaluating options for maintaining revenue streams, such as shifting effort to other target species. Alternatives 1d-3 and 1d-4 (a 3- or 5-year phase-in, respectively), would provide a longer transition time for the commercial industry to adapt to loss of fishing opportunity for scup. This could allow for a smoother transition to modified business models such as diversifying target species. As previously stated, these impacts would vary based on the magnitude of the allocation change as the commercial scup fishery has not harvested their full quota under the current allocations for many years due to market demand.

For the recreational fishery, a more abrupt transition to a revised allocation (alternative 1d-1 and to a lesser extent 1d-2) is expected to have social and economic benefits as this allows for a faster transition to an allocation that matches the recent recreational harvest under the revised MRIP data (Figure 3). This has implications for recreational management measures, which for scup, are currently resulting in harvest levels higher than the current RHL. Under the current allocation, this should require more restrictive measures to be implemented for the recreational fishery. However, under an increased allocation to the recreational fishery, it is possible that recreational scup measures could remain the same (avoiding potentially severe restrictions that would otherwise be taken if the allocations are not changed; Figure 3). Recreational measures are also dependent on factors such as future projections of stock biomass, trends in recreational catch and effort, and other trends. It is possible that if scup biomass is projected to increase in the coming years, recreational measures could be liberalized under an increased allocation. Alternatives 1d-3 and 1d-4 (a 3- or 5-year phase-in, respectively), would provide a longer transition to an increased recreational allocation for scup. This could mean that recreational measures and fishing opportunities would need to be restricted during the transition years, possibly severely given recent MRIP estimates (Figure 3), though it is important to note that adjustments to recreational measures depend on many different factors.

4.3.2.3 Black Sea Bass Phase-In Impacts

If the black sea bass allocation is modified but a landings-based allocation is maintained (alternatives 1c-5 through 1c-7), the annual percent shift amounts are easily calculated by taking the difference between the starting and ending allocations for each sector and evenly dividing that percentage among the 2, 3, or 5 years of phase-in depending on the phase-in alternative (Table 13).

Under a transition from a landings-based to a catch-based allocation (alternatives 1c-1 through 1c-3), dead discards would first need to be incorporated into the current baseline to determine the total and annual percent shift. Specifications for 2021 can serve as this baseline for the current split of catch by sector. Specifically, the percentage of the ABC that each sector will receive in 2021 as a sector ACL is used as the starting point for calculating transition percentages below (Table 9).

For black sea bass, in 2021, the commercial ACL represents 55% of the ABC and the recreational ACL represents 45% of the ABC (Table 9). From these starting percentages, the total amount of allocation shift can be calculated, and evenly divided among the 2, 3, or 5 years depending on the phase-in alternative (Table 13).

Table 13: Percent shift in black sea bass allocation per year for 2, 3, and 5 year phase-in options for all black sea bass allocation change alternatives.

Catch-Based Alternatives	Total amount of allocation percent shift needed^a	1d-2: 2 year phase-in	1d-3: 3 year phase-in	1d-4: 5 year phase -in
1c-1: 32% commercial, 68% recreational	23%	11.5% shift per year	7.7% shift per year	4.6% shift per year
1c-2: 28% commercial, 72% recreational	27%	13.5% shift per year	9.0% shift per year	5.4% shift per year
1c-3: 24% commercial, 76% recreational	31%	15.5% shift per year	10.3% shift per year	6.2% shift per year
Landings-Based Alternatives	Total amount of allocation percent shift needed^b	1d-2: 2 year phase-in	1d-3: 3 year phase-in	1d-4: 5 year phase -in
1-c4 (status quo): 49% commercial, 51% recreational	0%	N/A	N/A	N/A
1c-5: 45% commercial, 55% recreational	4%	2% shift per year	1.3% shift per year	0.8% shift per year
1c-6: 29% commercial, 71% recreational	20%	10% shift per year	6.7% shift per year	4% shift per year
1c-7: 22% commercial, 78% recreational	27%	13.5% shift per year	9% shift per year	5.4% shift per year

^a For catch-based alternatives, the starting point for this calculation is the current (2021) split of the sector-specific ACLs (which incorporates dead discards) instead of the landings limit allocation. Here, this shift is calculated by starting from the 2021 specifications which includes a commercial ACL that is 55% of the ABC, and a recreational ACL that is 45% of the ABC for black sea bass (Table 9).

^b For landings-based alternatives, the starting point for this calculation is the specified landings-based allocation (49% commercial/51% recreational). This does not account for dead discards, which would continue to be split using different methods with the resulting percentages varying depending on the year.

Across all the alternatives for black sea bass, the total allocation shift needed (if allocations are modified) from the commercial to the recreational fishery would range from 4-31%, compared to the current allocations, and the annual phase-in would range from 0.8% per year to 15.5% per year depending on the allocation change and the phase-in alternative selected (Table 13).

As described in Section 4.2, a reduced commercial allocation is expected to lead to loss of revenue, depending on the magnitude of the allocation change, especially in states where the commercial allocation is fully utilized. However, the potential loss in revenue may be partially offset by an increase in prices paid by dealers to fishermen if a price/volume relationship impacts prices under lower landings (Figure 6). The recreational sector is expected to experience positive social and economic impacts under any of the allocation changes proposed in alternatives 1c-1 through 1c-7 (with the exception of the no action/status quo alternative 1c-4). However, the positive impacts may be partially offset by an inability to meaningfully liberalize recreational management measures under a higher allocation given the transition to revised MRIP estimates, depending on the alternative (Figure 5). The phase-in option selected would affect how quickly these negative and positive impacts are felt by each sector, which could influence how well sector participants are able to adapt to any changes. For both sectors, these impacts will vary depending on the magnitude of the total allocation change, as well as the length of the phase-in period.

For the commercial industry, a more abrupt transition to a revised allocation (alternative 1d-1 and to a lesser extent 1d-2) may result in a sudden loss of income and jobs due to a more sudden drop in revenue in the commercial fishery. Commercial sector participants who are highly dependent on black sea bass may have more difficulty remaining in business while evaluating options for maintaining revenue streams, such as shifting effort to other target species. Alternatives 1d-3 and 1d-4 (a 3- or 5-year phase-in, respectively), would provide a longer transition time for the commercial industry to adapt to loss of fishing opportunity for black sea bass. This could allow for a smoother transition to modified business models such as diversifying target species.

For the recreational fishery, a more abrupt transition to a revised allocation (alternative 1d-1 and to a lesser extent 1d-2) could have social and economic benefits as this would allow for a faster transition to an allocation that matches the recent recreational harvest under the revised MRIP data. This has implications for recreational management measures, which for black sea bass, are currently resulting in harvest levels much higher than the current RHL. If the current allocation is maintained, more restrictive measures may need to be implemented to constrain harvest to the RHL. Under an increased allocation to the recreational fishery, it is possible that recreational black sea bass measures could remain the same (avoiding severe restrictions that could otherwise be required; Figure 5). Recreational measures are also dependent on factors such as future projections of stock biomass, trends in recreational catch and effort, and other trends. It is possible that if black sea bass biomass is projected to increase in the coming years and this allows for a higher ABC, recreational measures could be liberalized under an increased allocation. Alternatively, further restrictions could be needed if the ABC decreases. Alternatives 1d-3 and 1d-4 (a 3- or 5-year phase-in, respectively), would provide a longer transition to an increased recreational allocation for black sea bass. This could mean that recreational measures and fishing opportunities will need to be restricted during the transition years, possibly severely given recent MRIP estimates (Figure 5), though it is important to note that adjustments to recreational measures depend on many different factors.

5.0 QUOTA TRANSFER ALTERNATIVES AND IMPACTS

5.1 Quota Transfer Provision Alternatives

The following alternatives describe options for allowing annual transfer of quota between the commercial and recreational sectors as part of the specifications setting process (i.e., the annual process of setting or reviewing catch and landings limits for the upcoming fishing year). This process is similar to that currently used for bluefish, although the options below would allow transfers in either direction between sectors. Section 5.1.1 discusses quota transfer process alternatives while Section 5.1.2 addresses options for a cap on the total amount of a transfer.

5.1.1 Quota Transfer Process Alternatives

Table 14 lists the alternatives under consideration for quota transfer provisions.

Table 14: Alternatives for annual transfer of quota between the commercial and recreational sectors.

Annual Quota Transfer Alternatives
2a: No action/status quo (do not modify the FMP to allow transfers of annual quota between the commercial and recreational sectors.)
2b: Allow for optional bi-directional transfers through the annual specifications process with pre-defined guidelines and process. The transfer would consist of a portion of the total ABC in the form of a landings limit (i.e., commercial quota and RHL) transfer. Transfers would not occur if the stock is overfished or overfishing is occurring.

Under alternative 2a, transfers would not be allowed between the commercial and recreational sectors, consistent with past practice and the current FMP requirements for these species.

Under alternative 2b, each year during the setting or review of annual catch limits, the Board and Council could recommend that a portion of the total ABC be transferred between the recreational and commercial sectors as a landings limit transfer, affecting the final commercial quota and RHL. They could recommend a transfer from the commercial fishery to the recreational fishery or from the recreational fishery to the commercial fishery. If a transfer cap is adopted via one of the sub-alternatives under alternative 2c, the transfer amount could not exceed this cap.

Table 15 describes how the process of transfers would work within the Council and Board's current specifications process under alternative 2b.

Table 15: Proposed quota transfer process during a typical specifications cycle under alternative 2b.

<p>July: Assess the need for a transfer</p>	<p>Staff and the Monitoring Committee (MC) would assess the potential need for a transfer and develop recommendations to the Council and Board as part of the specifications process. The MC would consider the expected commercial quota and RHL (pending Council and Board review/approval) in the coming year, and each sector’s performance relative to landings limits in recent years. The MC will have very limited data for the current year and would not be able to develop precise current year projections of landings for each sector. The MC could also consider factors including but not limited to:</p> <ul style="list-style-type: none"> • Projected changes in stock size, availability, or year class strength; • Recent or expected changes in management measures; • Recent or expected changes in fishing effort; <p>The MC would consider how these factors might have different impacts on the commercial and recreational sectors. The effects of these considerations can be difficult to quantify and there is currently no methodology that would allow the MC to quantitatively determine the need for a transfer with a high degree of precision. The MC would use their best judgement to recommend whether a transfer would further the Council and Board’s policy objectives.</p>
<p>August: Council and Board consider whether to recommend a transfer</p>	<p>The Council and Board would consider MC recommendations on transfers while setting or reviewing annual catch and landings limits. The Council and Board would need to jointly agree on a transfer direction, amount of transfer, and if setting multi-year specifications, whether the transfer would apply for one year or multiple years.</p>
<p>October: Council staff submits specifications package to NMFS</p>	<p>Council staff would prepare and submit supporting documents to modify catch limits or implement or revise transfers. During a multi-year specifications review year, if a transfer is newly adopted or revised, a regulatory package may need to be developed even if catch limits do not change.</p>
<p>Mid-December: Recreational measures adopted*</p>	<p>The Council and Board would adopt federal waters recreational measures and a general strategy for coastwide recreational management including any reductions or liberalizations needed in state waters. These recommendations would be based on the expected post-transfer RHL which likely would not yet be implemented via final rule.</p>
<p>Late December: Final specifications published</p>	<p>NMFS approves and publishes the final rule for the following year’s catch and landings limits (if new or modified limits are needed), including any new or revised transfers. During a multi-year specifications review year, if a transfer is newly adopted or revised, rulemaking will likely need to occur even if catch limits do not change.</p>
<p>January 1: Fishing year specifications effective, including any transfers</p>	<p>Fishing year specifications including any transfers would be effective January 1. No post-implementation reviews or adjustments to the transfer amount would occur given that the final rule would recently have published and recreational measures would have already been considered based on expected post-transfer RHLs.</p>

*While this step is not directly part of the quota transfer process, the timing of the recreational measures setting process influences the necessary timeline of transfer-related decisions.

Note that while the transfer would occur at the landings limit level (commercial quota and RHL), for the purposes of maintaining accurate accounting and accountability at the ACL level, both sector’s ACLs would be adjusted to reflect the transfer at the landings limit level.

If transfer provisions under alternative 2b are adopted, some changes to the accountability measures (AMs) may also need to be considered. For example, AMs could specify that if the MC determines that a transfer caused the donating fishery's ACL, or the combined ABC, to be exceeded, the transfer amount could be deducted from the receiving fishery in a subsequent year. The Council and Board could consider a follow-on action to make these changes if desired. These specific changes are not considered through this amendment.

5.1.2 Transfer Cap Alternatives

Table 16 lists the alternatives under consideration for a cap on the total transfer amount (if any). These alternatives would only be considered if transfer provisions were adopted under alternative 2b above, and would specify a maximum percent of the ABC that could be transferred from one sector to another each year in the form of a landings limit transfer.

Table 16: Alternatives for annual transfer of quota between the commercial/recreational sectors.

Annual Quota Transfer Cap Alternatives
2c-1: No transfer cap specified; the Council and Board can recommend any amount of the ABC be transferred between fisheries.
2c-2: Maximum transfer amount set at 5% of the ABC.
2c-3: Maximum transfer amount at 10% of the ABC.
2c-4: Maximum transfer amount set at 15% of the ABC.

5.2 Impacts of Quota Transfer Provision Alternatives

The current FMP does not allow for the annual transfer of landings between the commercial and recreational sectors. Transfers are being considered as a way to address situations where landings limits in one sector exceed recent landings but fall below recent landings in the other sector. In short, transfers could provide flexibility when a landings limit is restrictive in one sector and the other sector has a surplus. However, the process for determining when a transfer is needed and how much to transfer could be complex, as described below.

Under alternative 2a (no action), there would be no change to the FMP to allow for transfers. Lacking this flexibility, the result when one sector is underachieving its limits and another sector is in need of additional allowable landings may be that limits remain set so that one sector is more likely to have an overage of catch, and the other sector may underutilize their allowable catch. This may negatively impact the ability to achieve the Council and Boards’ policy and FMP objectives on a short-term basis. If these trends persist, it could indicate a need for longer-term solutions such as further changes to the allocations.

The short-term impacts of not allowing transfers would be similar to current conditions, where in the event that there is surplus allocation to one sector and the other needs allocation, negative socioeconomic impacts could be expected for the sector in need of allocation. This sector would not be able to receive additional quota and may need restrictive management measures to constrain catch and may experience reduced revenues and/or reduced angler satisfaction as a result. The sector determined to have a surplus allocation would most likely experience no impacts under the

no action alternative; however, in some cases where conditions such as market factors or participation differ from what is predicted, this sector may experience slight positive impacts due to the opportunity to fish for their full allocation. These impacts may be less positive in practice if this sector is not able to fully utilize this quota.

Impacts associated with the proposed transfer process as well as sector-specific expected impacts of transfers are described in more detail below.

5.2.1 Impacts of the Proposed Process

A major disadvantage of the process proposed in Section 5.1.1 requires an annual evaluation of the need for a transfer in the upcoming year using data from the previous year (and potentially older data). Because in-year landings projections are not feasible with this timeline, this would cause at least a two-year disconnect in the timing of the data used to evaluate the need for transfer and the year in which the transfer would apply. This could result in a mismatch between the recommended transfer amount and direction and the reality of the fishery conditions and needs for the upcoming year.

The need for a transfer in any given year may be difficult to determine, due to several factors in addition to the timing of the data availability described above. These fisheries (particularly summer flounder and black sea bass) tend to fully or mostly utilize their allocation and sometimes experience overages. Annual changes in management measures are sometimes needed (especially in the recreational fisheries), and the effects of both past and expected future changes on expected harvest must be considered when determining a transfer amount. It is also difficult to predict changes in market factors that may influence whether the commercial fishery would utilize additional quota or has quota to spare.

Past sector performance for these fisheries may not be very informative when it comes to determining how often transfers will be needed. Because the recreational data currency has recently changed, pre-revision MRIP performance relative to the RHLs is not likely to be useful since the changes were not a simple linear scaling. In addition, any allocation changes implemented through this action may reduce the need for transfers. For these reasons, predicting the need for a transfer may be more straightforward in the future after additional years of evaluating harvest against catch and landings limits set in the new MRIP currency, and after any allocation changes implemented through this action have been in place for a few years. In this way, the ability to use transfers may be a useful “tool in the toolbox” for future years, as opposed to an option that is likely to be used in the more immediate future.

Looking solely at past trends in sector performance, transfer provisions may be most useful for the scup fishery given that the commercial quota has not been fully utilized for several years, but again, it is difficult to determine future transfer needs given the many uncertainties discussed here.

The MC recommendations for a transfer amount and direction would be based on an expected set of landings limits which would not yet have been reviewed or adopted by the Council and Board (Table 15). If these landings limits are modified by either the Council and Board or NMFS (e.g., if NMFS determines that a modification is necessary to account for a past year’s overage), the MC’s transfer recommendation may no longer be appropriate and it could be difficult for the Council and Board to adopt a modified transfer amount in time for the upcoming fishing year. The intent is that any transfer would be implemented before January 1 of the relevant fishing year, meaning that a mid-year quota change due to a transfer is not expected.

The conclusion about whether a transfer is needed could result in increased political discussion and potentially increased tensions between sectors during the specifications setting or review process.

As described in Section 5.1.1, recreational measures (typically determined in December) would need to be set using the expected post-transfer RHL. While typically there are no changes to the Council and Board's adopted RHL during the implementation process, it is possible that NMFS may change the RHL if circumstances require such modifications, such as if a recreational payback for an ACL overage is required. In practice, this may not represent a problem, since recreational measures are typically set based on the expected RHL. However, the use of transfers may further complicate this process if NMFS modifies or does not adopt the Council and Board recommendation for transfer.

If the Council and Board determine that the ability to use transfers during specifications is not desired, they could consider allowing for temporary transfers via FMP frameworks/addenda instead. This could be specified through alternative set 3 (Section 6.0). Annual transfers through a framework/addendum process would provide some additional flexibility in adapting to changing sector needs but would not allow for as timely of a response as would be possible through the specifications process.

5.2.2 Socioeconomic Impacts of Transfers

The impacts of transfers depend on the frequency of transfer, the amount transferred in each year, the direction of transfer between sectors, and to what extent each sector has been or is expected to achieve their limits. The impacts of a transfer are also dependent on the marginal economic value of additional allowable landings for each sector (in terms of commercial and for-hire revenues and revenues for associated commercial and recreational businesses), as well as the positive or negative impacts on angler satisfaction that may arise from modifying or maintaining recreational measures. As described below, many additional factors can influence how the commercial and recreational fisheries may be impacted by a transfer, including market conditions, overall availability of the species, availability of substitute species, and trends in effort driven by external factors.

Commercial to Recreational Transfers

If the recreational fishery receives a transfer, they would experience positive socioeconomic impacts due to outcomes such as the potential for liberalized measures, the ability to maintain status quo measures when a restriction may otherwise be needed, and/or a reduced risk of an RHL or ACL overage that may impose negative consequences in a future year. These outcomes could result in maintained or increased revenues for recreational businesses as well as improved or maintained levels of angler satisfaction, compared to if no commercial to recreational transfer occurred.

In this scenario, the commercial sector would give up quota that is not expected to be fully utilized. In theory, if the decision to transfer is based on a pattern of underutilization in the commercial sector, the economic impacts to the commercial sector from such a transfer would be neutral. However, the commercial sector could experience a loss in revenue if the potential for underutilization is incorrectly evaluated. This could be due to a disconnect in the data used to evaluate the transfer and conditions in the relevant fishing year, possibly driven by changes in market conditions or fishery participation and effort.

Impacts to the commercial fisheries are not likely to be felt equally across states given different commercial quota management systems and differing quota utilizations by state. While coastwide commercial landings can fall short of the total commercial quota, individual states vary considerably in utilizing or underutilizing their individual quotas. A coastwide projected underutilization could occur even if one or more states would be expected to fully utilize their quota in the upcoming year. This could have negative economic impacts to the commercial industries in states that regularly achieve their quotas.

Recreational to Commercial Transfers

If the commercial fishery receives a transfer, they would experience positive socioeconomic impacts in the year of the transfer due to increased revenue earning potential associated with higher potential landings. In general, quota increases tend to result in higher revenues, although some of these benefits may be partially offset by decreases in price per pound that can be associated with higher quotas. As described in Section 4.2, average ex-vessel price for each species tends to decrease with increasing landings. This relationship depends on the magnitude of the change in quota as well as other market factors in addition to total landings, so this relationship is difficult to predict. The relationship is also stronger for summer flounder and scup compared to black sea bass, so positive impacts of the commercial sector receiving a transfer are likely to be greater for black sea bass.

In theory, if the decision to transfer is based on a pattern of underutilization by the recreational sector, negative socioeconomic impacts to the recreational sector from such a transfer may not be realized. However, this would limit the potential for liberalizing recreational management measures. For these species, particularly for summer flounder and black sea bass, many stakeholders are of the opinion that recreational measures are currently overly restrictive. Because recreational harvest is more difficult to predict and control than commercial harvest, recreational management measures are frequently adjusted in order to strike an appropriate balance between conservation and angler satisfaction. Therefore, it may be less likely that a recreational to commercial transfer would actually occur.

Impacts of Transfers in Either Direction

The impacts of transfers should be considered in combination with the short-term and long-term impacts associated with commercial/recreational allocation modifications under alternative set 1. However, it is difficult to do so quantitatively given the uncertainties about allocation changes as well as the uncertainties in the frequency, amount, and direction of potential transfers. In general, any annual transfers away from a sector can compound the negative impacts experienced due to a reduction in that sector's total allocation, or in the short term could partially offset the positive impacts of an increase in allocation. Annual transfers to a sector can simultaneously create additional positive impacts on top of the positive impacts of reallocation from the perspective of the receiving sector, and also exacerbate negative impacts of a loss in allocation for the donating sector.

The impacts of transfers would also be influenced by annual reductions or increases in the overall ABC based on changes in projected stock biomass and the application of the Council's risk policy. The recipient of a transfer could have some negative socioeconomic impacts from ABC reductions mitigated by receiving a transfer, while the transferring sector may experience exacerbated negative economic impacts from ABC reductions. Conversely, if the ABC were increasing, this

could offset negative impacts to the transferring sector and provide additional benefits to the sector receiving the transfer.

As described above, the impacts of transfers may differ by state or region. For the commercial industry, the negative impacts associated with losing quota or the positive impacts associated with receiving a transfer are influenced by the method of quota allocation for each species. For summer flounder, commercial quota allocation will be revised as of January 1, 2021, and the state allocations are will then be tied to the overall coastwide commercial quota amount. This means that a transfer to or from the commercial quota could influence whether the coastwide commercial quota is above or below the quota threshold for modified allocations, which is currently specified at 9.55 million pounds. For black sea bass, a management action to potentially revise state commercial allocations is currently in development but a preferred alternative has not been identified, so it is difficult to predict the state or regional impacts of proposed quota transfers in combination with potential state allocation changes.

The impacts of transfers can also be impacted by the availability and management of substitute species for a particular sector. High availability and access to recreational or commercial substitute species would help mitigate negative impacts of a transfer away from a given sector, while lower availability and access would compound these negative effects.

Availability of a target species in a given year can also affect the outcome of a transfer, in the sense that availability influences catch rates and search costs associated with commercial and recreational trips. In general, it has been more difficult to calibrate recreational measures to constrain catch below the target level when availability for a species is high. This could drive managers to adopt commercial-to-recreational transfers more frequently under high availability conditions in order to avoid recreational overages.

5.2.3 Impacts of Transfer Cap Alternatives

Alternative set 2c (Section 5.1.2) contains options for setting a cap on the total amount of transfer between sectors, as a percentage of the ABC.

Alternative 2c-1 would specify that there is no transfer cap, meaning the Council and Board could recommend any amount of the ABC be transferred between sectors during the annual specifications process. This allows for maximum flexibility in changing the effective allocation in each year; however, this is also associated with a higher likelihood of politically contentious discussions during the annual specifications setting process and greater uncertainty about future effective sector allocations. The Council and Board could effectively consider large temporary reallocations on an annual basis. No transfer cap could also mean a very wide range of potential transfer amounts to consider and analyze. This could lead to less predictability and more frequent fluctuations in sector-specific landings limits from year to year, which could be amplified by changes in overall catch limits resulting from fluctuating stock projections. This could partially negate some of the positive impacts experienced by the sector receiving transfers, given that it could mean their adjustments in the following year may be more severe than if a transfer did not occur the prior year.

Alternatives 2c-2, 2c-3, and 2c-4 provide options for transfer caps set at 5%, 10%, and 15% of the ABC, respectively. This would provide less flexibility in adapting to circumstances where there may be a surplus of allocation in one sector but a deficit in the other. However, a transfer cap also limits consideration of larger allocation transfers through the specifications process and would

limit the politically contentious nature of this discussion and provide greater certainty in the effective sector allocations. Transfer caps would limit the allocation changes that could occur from year to year. Transfer caps would somewhat streamline the process of transfer consideration given that it would limit the range of what could be considered. A lower transfer cap (alternative 2c-2) would accomplish this more so than a larger cap (alternative 2c-4).

Under all alternatives, increased fluctuation in allocation from year to year could increase instability and unpredictability in landings limits, which could partially negate the positive impacts from a transfer even if a cap is in place, although transfer caps under alternatives 2c-2 through 2c-4 would lower the likelihood or severity of this, particularly if the cap is lower.

Under all transfer alternatives, if larger and/or more frequent transfers are adopted, this may indicate that the allocation is not properly specified in the FMP and consideration should be given to modifications to the allocation percentages.

Table 17 shows 5%, 10%, and 15% transfer caps in millions of pounds under the 2017-2021 high and low ABCs for each species. This is meant to provide an example of the amounts that could have been transferred between sectors under recent high and low ABCs. This does not represent a theoretical minimum or maximum amount of quota transfer in pounds, given that the transfer cap alternatives are specified as a percent of the ABC and will vary as ABCs change.

Between 2017-2021, alternative 2c-2 (5% cap) would have resulted in a cap between 0.45 and 1.96 million pounds depending on the species and year. Alternative 2c-3 (10% cap) would have resulted in a cap between 0.89 and 3.91 million pounds depending on the species and year. Alternative 2c-4 (15% cap) would have resulted in a cap between 1.34 and 5.87 million pounds depending on the species and year. Over this time period, scup would have had the highest average transfer cap given the highest average ABC, followed by summer flounder and then black sea bass.

Table 17: Example transfer caps under alternatives 2c-2 through 2c-4 for the 2017-2021 high and low ABCs for each species, in millions of pounds. Note that these are only examples using recent ABCs and do not represent a theoretical maximum or minimum transfer amount in pounds.

		Summer Flounder	Scup	Black Sea Bass
ABC for comparison	2017-2021 Low ABC	11.30	28.40	8.94
	2017-2021 High ABC	27.11	39.14	17.45
2c-2: 5% of ABC	2017-2021 Low Transfer Cap	0.57	1.42	0.45
	2017-2021 High Transfer Cap	1.36	1.96	0.87
2c-3: 10% of ABC	2017-2021 Low Transfer Cap	1.13	2.84	0.89
	2017-2021 High Transfer Cap	2.71	3.91	1.75
2c-4: 15% of ABC	2017-2021 Low Transfer Cap	1.70	4.26	1.34
	2017-2021 High Transfer Cap	4.07	5.87	2.62

6.0 FRAMEWORK/ADDENDUM PROVISION ALTERNATIVES AND IMPACTS

6.1 Framework/Addendum Provision Alternatives

The alternatives in Table 18 consider whether the Council and Board should have the ability to make future changes related to certain issues considered through this amendment through a

framework action (under the Council's FMP) and/or an addendum (for the Commission's FMP). Frameworks/addenda are modifications to the FMPs that are typically (though not always) more efficient than a full amendment. While amendments may take several years to complete and may be more complex, frameworks/addenda can usually be completed in 5-8 months. Both types of management actions include multiple opportunities for public input; however, scoping and public hearings are required for amendments, but are optional for frameworks/addenda. Frameworks/addenda can only modify existing measures and/or those that have been previously considered in an FMP amendment.

The framework/addenda provisions would apply to commercial/recreational allocation changes (alternative set 1) and quota transfer provisions between the commercial and recreational sectors (alternative set 2). The ability to revise commercial/ recreational allocations through a framework or addendum could make future allocation changes simpler and less time consuming. The Council adopted an allocation review policy in 2019,⁸ where each relevant allocation will be reviewed at least every 10 years; however, the Council may choose to conduct reviews more frequently based on substantial public interest or other factors (including changes in ecological, social, and economic conditions). Framework/addendum provisions are also considered for transfers of quota between sectors, as this may allow for a more efficient management response to changes in the needs of the commercial and recreational fisheries for these species than if these changes needed to be considered through an FMP amendment, as is currently the case.

Allowing such changes through a framework/addendum **does not require or guarantee that this mechanism can be used for future changes**. The Council and Board can always choose to initiate an amendment rather than a framework/addendum if more thorough evaluation or additional public comment opportunities are desired. In addition, if the specific changes under consideration are especially controversial or represent a significant departure from previously considered measures, an amendment may be required, even if the type of change is identified in the FMP as a change that can be made through a framework/addendum.

Table 18: Framework/addendum provision alternatives.

Framework/addendum provision alternatives
3a: No action/status quo (no changes to framework/addendum provisions; changes to commercial/recreational allocations must be made through an amendment)
3b: Allow changes to commercial/recreational allocations, annual quota transfers, and other measures included in this amendment to be made through framework actions/addenda

6.2 Impacts of Framework/Addendum Provision Alternatives

The impacts of alternatives 3a and 3b are briefly described below. These alternatives are primarily procedural in nature. The purpose of modifying the list of “frameworkable items” in the FMP is to demonstrate that the concepts included on the list have previously been considered in an amendment (i.e., they are not novel).

Alternative 3a would make no changes to the current list of framework provisions in the Council's FMP and no changes to the current list of measures subject to change under adaptive management in the Commission’s FMP. Any future proposed modifications to the commercial/recreational allocations or proposed allocation transfer systems would likely require a full FMP amendment.

⁸ https://www.mafmc.org/s/MAFMC-Fishery-Allocation-Review-Policy_2019-08.pdf

The timeline and complexity of such an amendment would depend on the nature of the specific options considered.

Alternative 3b would allow changes to commercial/recreational allocations and sector allocation transfer provisions to be implemented through a framework action (for the Council) and/or an FMP addendum (for the Commission). This alternative is intended to simplify and improve the efficiency of future actions to the extent possible and would not have any direct impacts on the environment or human communities as it is primarily procedural in nature. As previously stated, under alternative 3b, the Council and Board could still decide it is more appropriate to use an amendment if significant changes are proposed. The impacts of any specific changes to the commercial/ recreational allocations or transfers between the sectors considered through a future framework/ addendum would be analyzed through a separate process with associated public comment opportunities and a full description of expected impacts.

7.0 APPENDICES

APPENDIX A: Catch vs. Landings-Based Allocations

This appendix provides additional clarification on the differences between catch and landings-based allocations. These allocations are used to derive a set of required annual catch and landings limits for both sectors, including commercial and recreational annual catch limits and annual catch targets (ACLs and ACTs⁹, which both account for landings and dead discards), and landings limits (commercial quota and RHL, both of which only account for landings). The same types of catch and landings limits are all required under both catch and landings-based allocations. These limits are calculated through the annual specifications process. The commercial/recreational allocations are not used in other parts of the management process; they are only used in the specifications process to derive the sector-specific catch and landings limits.

In both cases, all catch and landings limits are derived from the overall ABC, which applies to all dead catch and is set based on the best scientific information available. The main difference between catch and landings-based allocations is the step in the process at which the commercial/recreational allocation is applied and how dead discards are factored into the calculations.

A **catch-based** allocation allocates the total ABC (which accounts for both landings and dead discards) between the two sectors as commercial and recreational ACLs, based on the allocation percentages defined in the FMP (catch-based step 1 in the figures below). Dead discards are then estimated for each sector and subtracted from the sector ACLs to derive the annual sector landings limits (commercial quota and RHL).

A **landings-based** allocation applies the allocation percentage defined in the FMP to only the portion of the ABC that is expected to be landed (landings-based steps 1 and 2 in the figures below). This requires first calculating the amount of expected dead discards from both sectors combined and subtracting that from the ABC (landings-based step 1), so that the allocation percentage can be applied to the total allowable landings (landings-based step 2). Dead discards are still projected for each sector and incorporated into the ACLs under a landings-based

⁹ ACTs are set equal to or lower than the ACLs to account for management uncertainty. For these species, ACTs have typically been set equal to the ACLs in recent years.

allocation, but the process is more complex due to the need to separate out total landings first to apply the allocation. This process evolved because management of summer flounder and black sea bass was previously based on landings limits only and did not consider dead discards. When dead discards were first incorporated into management, the allocation percentages continued to be applied to landings only and it was determined that other methods were needed to split expected dead discards by sector.

As described in more detail below, in both cases, sector-specific dead discards are generally estimated based on recent trends in the fisheries. Therefore, **under a landings-based allocation, recent trends in dead discards in one sector have more of an impact on the catch and landings limits in the other sector. Under a catch-based allocation, the calculations of sector-specific catch and landings limits are more separate and recent trends in landings and dead discards in one sector have a lesser impact on the limits in the other sector.** This can have important implications due to sector-specific differences in factors such as how landings and discards are estimated, the factors influencing discards (e.g., regulations, market demand, catch and release practices), and discard mortality rates.

Under both allocation approaches, the commercial/recreational allocation percentages are fixed (until modified through an FMP action) and do not vary based on recent trends in the fisheries. They would be defined based on one of the alternatives listed in Section 4.0 of this document.

More details, including a description of the subsequent steps to arrive at the commercial quota and RHL are included below. Examples of the implications of each approach are included at the end of this section.

Projected Discards Under Both Allocation Approaches

For scup and summer flounder, the total amount of the ABC expected to come from dead discards can be projected using the stock assessment model. These projections account for variations in the size of different year classes (i.e., the fish spawned in a given year) and catch at age information from the commercial and recreational sectors. The current stock assessment model for black sea bass does not allow for these projections, so alternative methods such as recent year average proportions need to be used.

Regardless of the allocation approach, the methodology for calculating sector-specific dead discards (as opposed to total dead discards) is not defined in the FMP and can vary based on annual considerations. The Monitoring Committee provides advice on this decision.

Under both approaches, only **dead** discards are factored into the allocation percentages and the catch and landings limits calculations. Discarded fish which are presumed to survive do not factor into these calculations.

Catch-based Allocation Process

The allocation percentages under consideration are listed in Section 4.1. Those allocation percentages are then used in the specifications process as described below.

Catch-based Step 1. The ABC is divided into commercial and recreational ACLs based on the allocation percentages defined in the FMP.

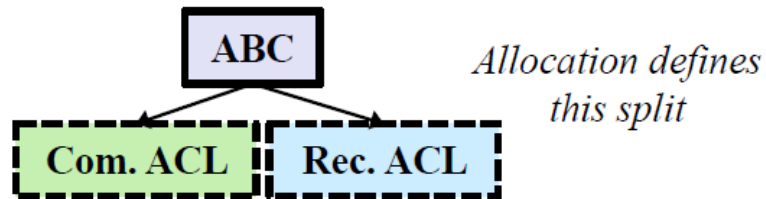

Catch-based Step 2. Commercial and recreational ACTs are set less than or equal to their respective ACLs to account for management uncertainty. The appropriate deduction for management uncertainty (if any) is not pre-defined and is based on annual considerations, including the advice of the Monitoring Committee.

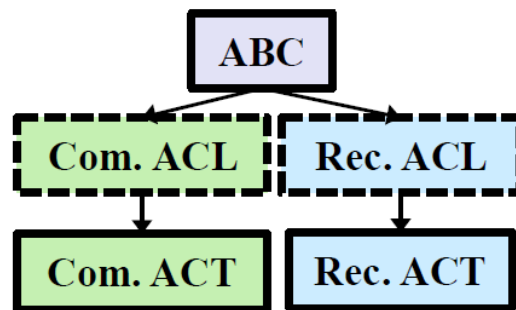

Catch-based Step 3. Expected dead discards are calculated for each sector to derive the commercial quota and RHL from the sector-specific ACTs.

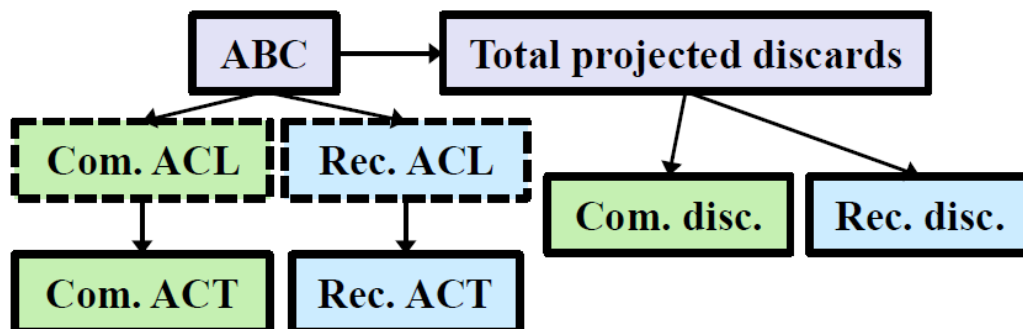

Catch-based Step 4. Commercial quotas and RHLs are determined by subtracting the sector-specific dead discards (see catch-based step 3) from the sector-specific ACTs.

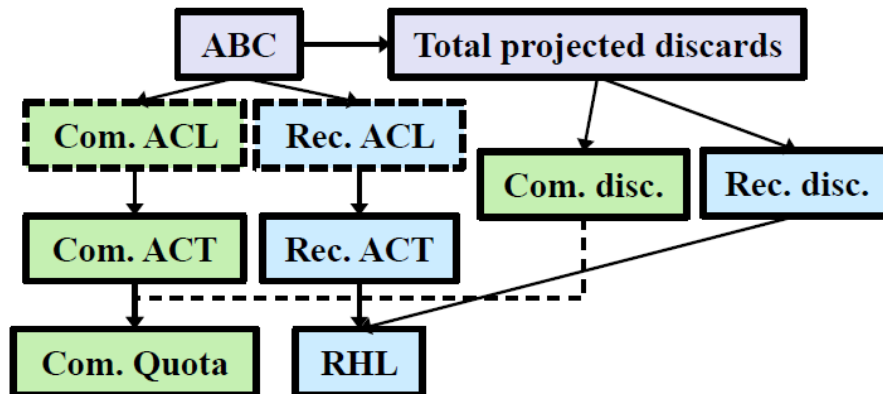

Landings-Based Allocation Process

Landings-based Step 1. The ABC is first divided into the amount expected to come from landings (total projected landings) and the amount expected to come from dead discards (total projected dead discards). The methodology for this calculation is not defined in the FMP and can vary based on annual considerations. The Monitoring Committee provides advice on this decision.

As previously stated, for scup and summer flounder, these calculations can be informed by stock assessment projections. The current black sea bass stock assessment does not model landings and dead discards separately; therefore, calculations of total projected landings and dead discards for black sea bass cannot be informed by stock assessment projections. Instead, other methods, such as those based on recent year average proportions, must be used.

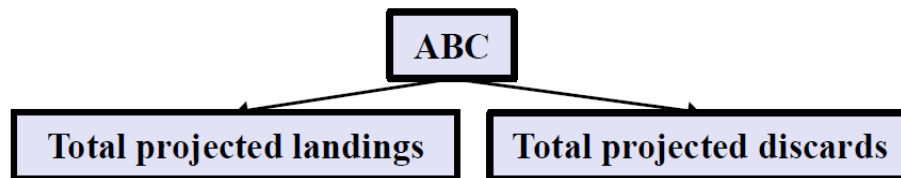

Landings-based Step 2. The total projected landings are allocated to the commercial and recreational sectors based on the allocation percentages defined in the FMP.

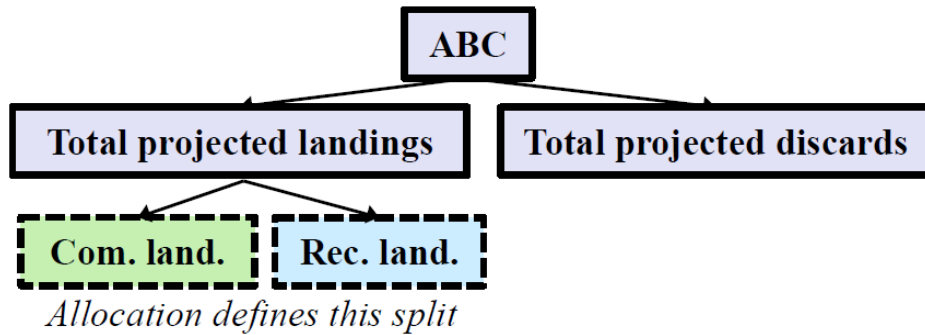

Landings-based Step 3. The total projected dead discards are split into projected commercial dead discards and projected recreational dead discards. The methodology for calculating sector-specific dead discards is not defined in the FMP and can vary based on annual considerations. The Monitoring Committee provides advice on this decision.

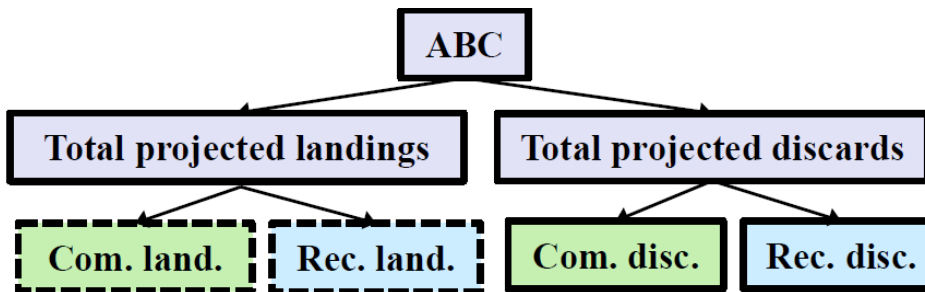

Landings-based Step 4. Commercial and recreational ACLs are calculated by adding the landings amount allocated to each sector and the sector-specific projected dead discards (see Steps 2 and 3 above).

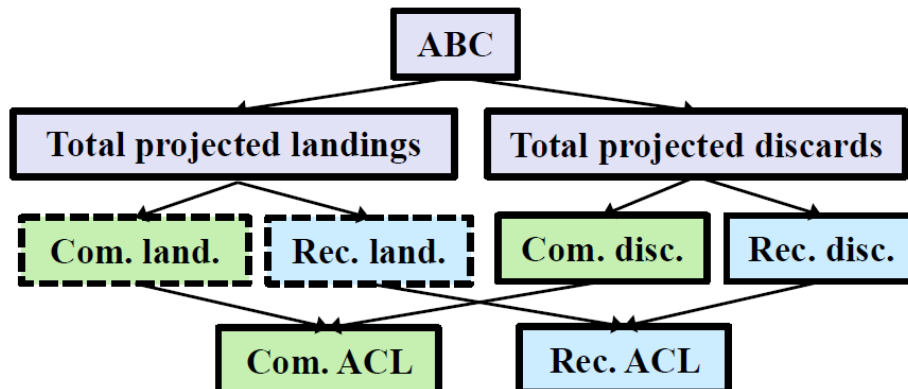

Landings-based Step 5. Commercial and recreational ACTs are set less than or equal to their respective ACLs to account for management uncertainty. The appropriate deduction for management uncertainty (if any) is not pre-defined and is based on annual considerations, including the advice of the Monitoring Committee.

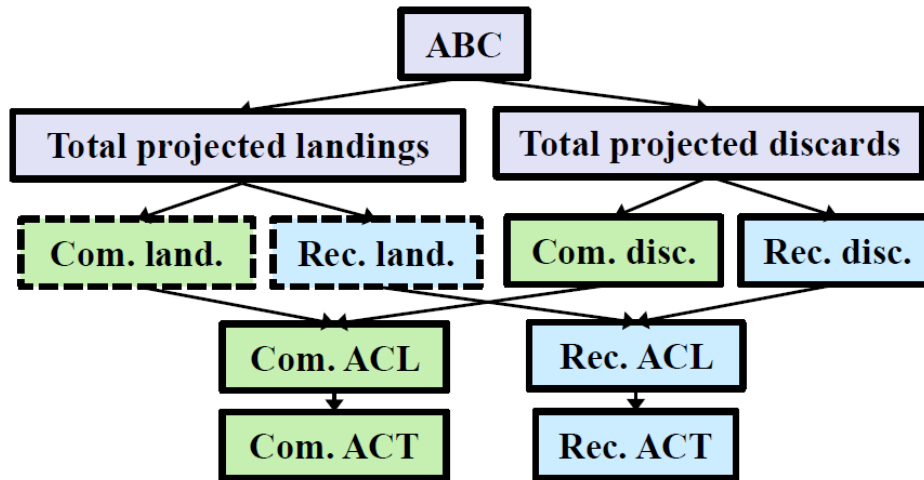

Landings-based Step 6. Commercial quotas and RHLs are determined by subtracting sector-specific discards from the sector-specific ACTs.

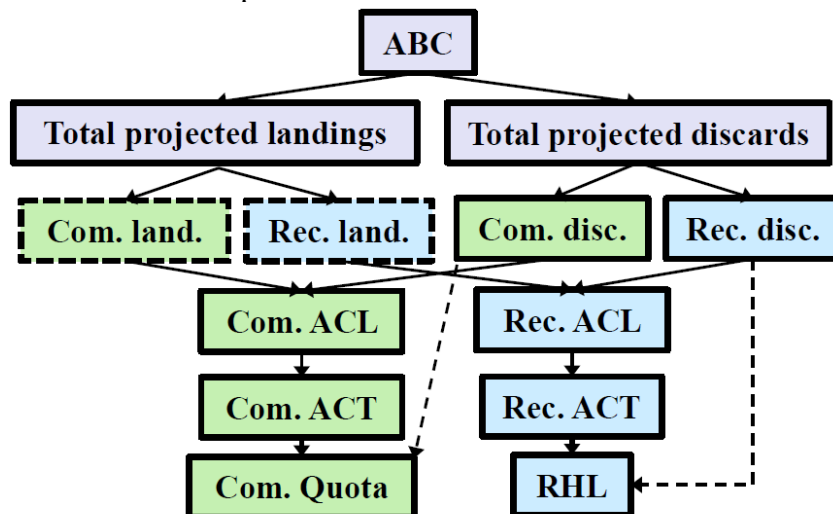

Implications of Catch vs. Landings-Based Allocation Approaches

One of the major differences between catch-based and landings-based allocations is at which step in the process the commercial/recreational allocation is applied to derive catch and landings limits. Under a catch-based allocation, the commercial/recreational allocation is applied in the first step of the process after the ABC is determined. Under a landings-based allocation, decisions about the total amount of expected landings and dead discards must be made before the commercial/recreational allocation is applied. The commercial/recreational allocation is then applied to the total amount of expected landings (Figure 7).

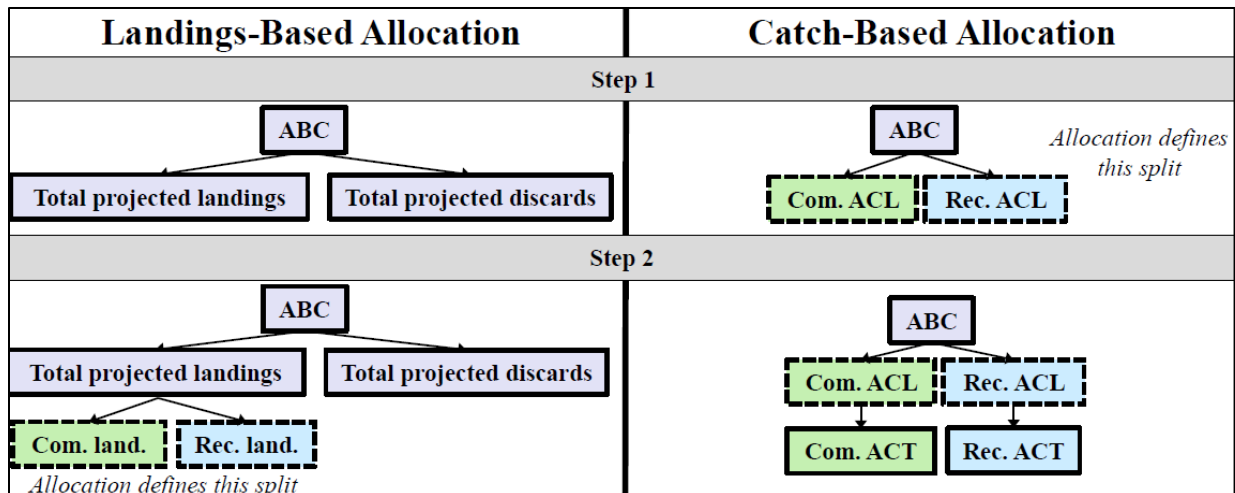

Figure 7: Comparison of first two steps of calculating commercial and recreational catch and landings limits under catch and landings-based allocations.

The method for determining total expected landings and dead discards under a landings-based approach is not specified in the FMP and can vary based on annual considerations. In practice, this typically involves consideration of stock assessment projections and/or recent trends in landings and dead discards, depending on the species. In this way, considerations of recent trends in the stock and discard trends in either the commercial or recreational fishery impacts both sector’s catch and landings limit under a landings-based allocation to a greater extent than under a catch-based allocation.

Under a catch-based allocation, the total ABC is always allocated among the commercial and recreational sectors in the same way (i.e., based on the allocation percentages defined in the FMP) regardless of recent trends in year classes or landings and dead discards in each sector. Put another way, under a catch-based allocation, changes in landings and dead discards in one sector do not influence the other sector’s ACL as the entire ABC is always split among the sectors based on the allocation defined in the FMP, regardless of recent trends in landings and discards by sector. In theory, this can allow each sector to see the benefits of a reduction in their own dead discards to a greater extent than under a landings-based allocation. Under a catch-based allocation, a reduction in dead discards in one sector can result in an increase in that sector’s landings limit in a future year. This was part of the rationale for implementing the current catch-based allocation for scup as it was expected to incentivize a reduction in commercial dead discards, which were of concern during development of Amendment 8. Under a landings-based allocation, changes in landings and dead discards in one sector can influence the catch and landings limits in both sectors; therefore, the benefits of a reduction in dead discards (or the negative impacts of an increase in dead discards) in one sector can also be felt by the other sector.

Although catch- and landings-based allocations may create different incentives for reducing dead discards in each sector, in reality, this may be a long-term impact. With the exception of the no action alternatives, all the allocation alternatives under consideration through this amendment are based on historical patterns in the fisheries considering the best available recreational and commercial data, either using the original base years or considering data through 2018 or 2019, depending on the alternative (Section 4.1). Therefore, the catch or landings-based allocations under

many of the alternatives may not create an immediate notable incentive for change compared to recent operating conditions. Selection of catch versus landings-based allocations does have an immediate effect on each sector's landings limit. Appendix C presents a methodology for projecting landings limits under the catch- and landings-based allocation alternatives, and Section 4.2 compares recent trends in landings data to the projected landings limits under each allocation alternative.

APPENDIX B: Supplemental Information on Basis for Allocation Alternatives

This appendix describes the rationale behind each of the commercial/recreational allocation percentage alternatives listed in alternative sets 1a-1c (Table 19). These alternatives were initially developed by the FMAT (Fishery Management Action Team) and approved by the Council and Board for inclusion in this amendment.

Table 19. Alternatives considered through this amendment for commercial/recreational allocation percentages (i.e., alternative sets 1a – summer flounder, 1b - scup, and 1c – black sea bass) grouped according to the approach used to derive the alternatives.

Approach	Description	Associated Alternatives
A	No action/status quo	1a-4, 1b-1, 1c-4
B	Same base years as current allocations (varies by species) but with new data	1a-5, 1b-2, 1b-5*, 1c-5
C	2004-2018 base years	1a-1, 1a-6*, 1b-6, 1c-2
D	2009-2018 base years	1a-2*, 1a-6*, 1b-3*, 1b-5*, 1c-3, 1c-7*
E	2014-2018 base years	1a-3, 1a-7, 1b-5*, 1c-7*
F	Approximate status quo harvest per sector compared to 2017/2018 (summer flounder) or 2018/2019 (scup, black sea bass)	1a-2*, 1b-4, 1b-7, 1c-1, 1c-6*
G	Average of other approaches approved by Council/Board in June 2020	1a-2*, 1b-3*, 1c-6*

*indicates an alternative supported by multiple approaches.

Approach A (no action/status quo)

The no action/status quo alternatives consider the consequences of taking no action and retaining the current commercial/recreational allocations. It is required that all Council and Commission amendments consider no action/status quo alternatives.

Approach B (same base years as current allocations but with new data)

This approach would use updated recreational and commercial data from the same base years as the current allocations to inform new allocation percentages. This is the basis (or, depending on the alternative, part of the basis) for alternatives 1a-5, 1b-2, 1b-5, and 1c-5.

Both catch and landings-based alternatives using this approach are considered for scup (alternatives 1b-2 and 1b-5, respectively). However, for summer flounder and black sea bass, only landings-based alternatives using this approach are considered (alternative 1a-5 for summer flounder and 1c-5 for black sea bass). This is because dead discard estimates in weight are not available for all the current base years for summer flounder (i.e., 1980-1989) and black sea bass (i.e., 1983-1992). Estimates of landings and dead discards in weight in both sectors are available for all the current base years for scup (i.e., 1988-1992).

MRIP does not provide estimates of recreational catch or harvest prior to 1981; therefore, the full 1980-1989 base years for summer flounder cannot be re-calculated for the recreational fishery. Instead, alternative 1a-5 uses 1981-1989 as the base years.

The rationale behind the selection of the current base years for each species is not explicitly defined in the FMP amendments that first implemented the commercial/recreational allocations. The current base years for scup and black sea bass are all years prior to Council and Commission management. For summer flounder, the Commission FMP was adopted in 1982 but contained mostly management guidelines rather than required provisions. The joint Council and Commission FMP was adopted in 1988, toward the end of the 1980-1989 base year period used to develop allocations. The management program for summer flounder was quite limited until Amendment 2 was implemented in 1993. The current base years for each species were likely chosen based on a desire to use as long of a pre-management time period as possible considering the limitations of the relevant data sets.

The approach of revising the commercial/recreational allocations using the same base years and new data allows for consideration of fishery characteristics in years prior to influence by the commercial/recreational allocations, while also using what is currently the best scientific information available to understand the fisheries in those base years.

Approach C (2004-2018 base years), approach D (2009-2018 base years), and approach E (2014-2018 base years)

Under approaches C, D, and E, the commercial/recreational allocation for each species would be based on the proportion of catch or landings from each sector during the most recent 15, 10, or 5 years through 2018, respectively. Final 2019 data from both sectors were not available during initial development of these alternatives; therefore, this amendment only considers catch and landings data through 2018.

The fisheries have changed notably since the commercial/recreational allocations were first implemented in 1993 for summer flounder, 1997 for scup, and 1998 for black sea bass. Most notably, all three species were under rebuilding programs when these allocations were first implemented. According to the most recent stock assessment information, none of the three species are currently overfished or experiencing overfishing. Black sea bass and scup biomass levels are particularly high, at 237% and 198% of the target levels in 2018, respectively. Summer flounder biomass was at 78% of the target level in 2017.¹⁰

Other characteristics of the fisheries have also changed. Limited access programs for the commercial fisheries were implemented after the initial allocation base years. Possession limits and required minimum fish sizes in both sectors were implemented and have constrained both commercial and recreational harvest. Reporting and monitoring systems and requirements in both sectors have improved. Socioeconomic conditions such as demand for seafood and the demographics and number of both commercial and recreational fishermen have also shifted.

For these reasons, this amendment will consider allocation percentages based on more recent trends in the fisheries compared to the initial base years. The FMAT, Council, and Board agreed that the most recent 15, 10, and 5 years (through 2018) are reasonable time periods to consider.

During these time periods, the fisheries were theoretically constrained by the current allocations. However, the commercial fisheries were generally held closer to their allocations than the recreational fisheries, even when measuring recreational harvest with the pre-calibration MRIP

¹⁰ Stock assessment reports for these species can be found at: <https://www.fisheries.noaa.gov/resource/publication-database/northeast-stock-assessment-documents-search-tool>.

data available prior to 2018. Due to the nature of these fisheries, the commercial fisheries have been much more comprehensively monitored in a more timely manner than recreational fisheries during these time periods. All federally permitted commercial fishermen are required to sell their catch to federally permitted dealers, and those dealers must submit landings reports on a weekly basis. If commercial fisheries are projected to land their full quota prior to the end of the year or quota period, they can be shut down. The commercial fisheries have rarely exceeded their quotas by notable amounts over the past 15 years due to close monitoring and reporting.

Recreational harvest is monitored through a combination of voluntary responses to MRIP surveys and VTR data from federally permitted for-hire vessels. Preliminary MRIP data are provided in two month “wave” increments and are not released until approximately two months after the end of the wave. Final recreational data are generally not available until the spring of the following year. Due to the delay in data availability, in-season closures are not used for these recreational fisheries. Recreational fisheries are primarily managed with a combination of possession limits, minimum fish sizes, and open/closed seasons that are projected to constrain harvest to a certain level. However, recreational harvest is influenced by a number of external factors, and the level of harvest associated with a specific combination of possession limits, minimum fish sizes, and open/closed seasons can be difficult to accurately predict. Compared to commercial effort, recreational effort is more challenging to manage, especially considering the recreational sector is an open access fishery. For these reasons, recreational harvest is not as tightly controlled and monitored as commercial landings.

In summary, there are tradeoffs associated with allocations based on recent fishery performance. These allocations could better reflect the current needs of the fisheries and be more responsive to changes in the fisheries and stocks compared to allocations using the initial base years. However, these alternatives would reallocate based on time periods when the recreational fishery was effectively less constrained to their limits than the commercial fishery. The implications may be different for each of the three species, and the issues should be carefully considered. From 2004-2018, scup tended to have more consistent quota and RHL underages in both sectors than summer flounder and black sea bass, and black sea bass had much more consistent RHL overages than the other two species (in all cases considering the pre-calibration MRIP data available prior to 2018).

Approach F: Approximate status quo harvest per sector compared to 2017/2018 (summer flounder) or 2018/2019 (scup, black sea bass)

Rationale

The intent behind this approach is to modify the percentage allocations to allow for roughly status quo landings in both sectors under the 2020-2021 ABCs for all three species compared to year(s) prior to the recent catch limit revisions based on the most recent stock assessments. This approach was developed prior to the August 2020 Council and Board meeting when both groups agreed to revise the 2021 ABCs for all three species; therefore, this approach considers the previously implemented 2021 ABCs. Compared to the previously implemented 2021 ABCs, the revisions approved by the Council and Board in August 2020 represent an increase of 8% for summer flounder, 13% for scup, and 9% for black sea bass.

The most recent stock assessments for all three species incorporated the revised MRIP data as well as updated commercial fishery data and fishery-independent data through 2017 for summer flounder and 2018 for scup and black sea bass. Catch and landings limits based on these

assessments were implemented in 2019-2021 for summer flounder and 2020-2021 for scup and black sea bass. Identical catch and landings limits across each year were implemented for summer flounder and black sea bass. For scup, the catch and landings limits varied across 2020-2021.

For summer flounder, these changes resulted in a 49% increase in the commercial quota and RHL in 2019 compared to 2018. Despite the increase in the RHL, recreational management measures could not be liberalized because the revised MRIP data showed that the recreational fishery was already harvesting close to the increased RHL. The increased commercial quota allowed for an increase in commercial landings.

For black sea bass, these changes resulted in a 59% increase in the commercial quota and RHL for 2020 compared to 2019. Status quo recreational measures for black sea bass were expected to result in an overage of the increased 2020 RHL; however, the Council, Board, and NMFS agreed to maintain status quo recreational management measures for 2020 to allow more time to consider how to best modify recreational management in light of the new MRIP data. Commercial landings appear to have increased in response to the increase in the quota; however, they are not likely to increase by the full 59% due to the impacts of the COVID-19 pandemic on market demand.

For scup, these changes resulted in a decrease in the commercial quota (-7%) and RHL (-12%) in 2020 compared to 2019. Status quo recreational measures for scup in 2020 were maintained based on similar justifications described above for black sea bass as well as the expectation that the commercial fishery would continue to under-harvest their quota due to market reasons.

Given these circumstances, an attempt was made to calculate revised commercial/recreational allocations for all three species such that harvest in each sector could remain similar to pre-2019 levels for summer flounder and pre-2020 levels for scup and black sea bass (i.e., the years prior to implementation of the most recent stock assessments for all three species), at least on a short-term basis under the current ABCs. This would require lower commercial quotas than those currently implemented for all three species. However, the Council and Board agreed that this approach warrants further consideration given that the commercial quotas for summer flounder and black sea bass increased by 49% and 59% respectively as a result of the most recent stock assessments, the commercial scup quota has been under-harvested for over 10 years. The recreational black sea bass and scup fisheries are facing the potential for severe restrictions based on a comparison of the revised MRIP data in recent years to the current RHLs under the existing allocations.

Defining status quo for each species and sector

Due to unique circumstances in each fishery, the status quo harvest target under this approach was not defined the same way across all species and sectors. Recreational harvest can vary notably from year to year, even under similar management measures. For this reason, recreational status quo for all three species was defined as average recreational harvest in pounds during the two years prior to the most recent catch limit revisions (i.e., 2017-2018 for summer flounder and 2018-2019 for scup and black sea bass). Commercial scup landings are also variable and have been below the quota since 2007 for market reasons. Therefore, status quo for the commercial scup fishery was also defined as a recent two-year average of harvest (2018-2019). For summer flounder and black sea bass, commercial status quo was defined as landings in the last year prior to revisions based on the most recent assessments (i.e., 2018 for summer flounder and 2019 for black sea bass). This reflects the fact that commercial summer flounder and black sea bass landings are generally close to the quotas.

Status quo levels of discards for each species and sector were defined using the same years described above for landings. At the time that this approach was developed, discard estimates in weight for 2019 were not available for either sector; therefore, it was assumed that 2019 discards would be equal to the 2016-2018 average for all species and sectors. Because the Council and Board approved specific allocation alternatives in August 2020, this analysis was not updated with the 2019 discard data that has since become available.

Methodology for calculating allocations

This approach considers the 2020 - 2021 ABCs (or, in the case of scup, the average of the 2020 and 2021 ABCs). Because this approach would modify the commercial/recreational allocation percentages, expected harvest and discards in each sector could not be calculated with the same methods used for setting the 2020-2021 specifications. Instead, initial values for expected dead discards by sector were calculated by dividing the 2020-2021 ABCs into expected total (i.e., both sectors combined) landings and total dead discards based on the average proportion of total landings and dead discards during 2017-2019 (see note above about 2019 discards). The expected total amount of dead discards was then divided into commercial and recreational discards based on the average contribution of each sector to total dead discards during 2017-2019. Initial expected harvest was defined as the status quo level of landings in each sector described above. These were the target commercial quotas and RHLs. As described below, these initial values for both harvest and dead discards were modified during subsequent steps of the analysis.

For summer flounder, total expected catch was 18% below the 2020-2021 ABC. This surplus allowable catch was split evenly among the two sectors. The resulting catch and landings limits, including expected dead discards in each sector, were modified to account for this surplus. For scup, total expected catch was 9% above the 2020-2021 average ABC. For black sea bass, total expected catch was 2% above the 2020-2021 ABC. For both scup and black sea bass, the catch reduction necessary to prevent an ABC overage was evenly split between the two sectors. Thus, true status quo was not be maintained for any of the three species under this example. For summer flounder, both sectors were able to slightly liberalize compared to the definition of status quo described above. For scup and black sea bass, both sectors had to be slightly restricted. The resulting catch and landings limits were then used to define the allocation percentages in Table 20. These are the allocation percentages for consideration under this approach.

Table 20. Allocations aiming to allow approximately status quo landings in each sector under the 2020-2021 ABCs compared to recent years prior to catch limit revisions based on the most recent stock assessments.

Sector	Catch-based			Landings-based		
	Summer flounder	Scup	Black sea bass	Summer flounder	Scup	Black sea bass
Commercial	43%	59%	32%	43%	50%	29%
Recreational	57%	41%	68%	57%	50%	71%

Approach G (average of other approaches approved by Council/Board in June 2020)

The FMAT developed several allocation alternatives during May and June 2020. Many of these approaches resulted in very similar allocation percentages. The Council and Board refined the list of alternatives under consideration in June 2020 and agreed that it would be appropriate to consider

an option for each species that averages the other alternatives in recognition of the similarities in outcomes across many alternatives.

Although this approach does not have a quantitative basis that is distinct from the other alternatives, the FMAT agreed that this is appropriate. They also emphasized that there is not necessarily a clear, objective scientific basis for a single best way to approach these allocations, and that the final decision will be a policy and judgement call between a number of defensible options.

APPENDIX C: Example Quotas and RHLs Under Each Allocation Alternative

This appendix provides examples of potential quotas and RHLs for each of the commercial/recreational allocation percentage alternatives listed in alternative sets 1a-1c (Table 19). Commercial quotas and RHLs are developed or reviewed annually through consultation with the MC and approved upon Council and Board review. As described below, given several assumptions that need to be made about how dead discards are handled, it is not possible to precisely predict what quotas and harvest limits would be under each allocation. This analysis provides the best approximation of possible limits available at this time.

Dead Discard Projection Methodology

Projecting dead discards is a key component in developing landings limits. Typically, summer flounder and scup total dead discards are based on the stock assessment projections and black sea bass total dead discards are based on a 3-year average of dead discards as a percent of total dead catch. The MC then takes into consideration recent trends and other relevant factors to split the total projected dead discards into dead discards by sector. Projecting expected future commercial quotas and RHLs under revised allocations is complicated because large shifts in allocations are expected to impact recreational and commercial effort, which may result in changes in dead discards for each sector in addition to changes in landings. As such, under modified allocations there would be a transition period where recent trends in dead discards by sector would not be particularly informative for projecting what sector discards would be under new allocations. Expected dead discards by sector under revised allocations are thus better predicted by modeling the relationship between dead catch, landings and discards. This can then be used to project dead discards under example catch and landings limits for each allocation alternative. The modeling process involves assumptions and like any model it is imperfect, but hopefully informative as well. This method is not necessarily the method that the MC will have to use in future specifications development, and they will still have the opportunity to adjust the dead discard projections based on expected changes in stock size, or year class strength, recent changes in management measures, and recent changes in fishing effort.

The following methodology for producing dead discard projections was based on the assumption that there is a relationship between dead discards and catch/landings. Examination of recent trends in black sea bass dead discards and catch/landings reveals a strong positive linear relationship in both the recreational and the commercial fisheries. This is to be expected for catch which is comprised of both landings and discards, but the positive relationship between landings and dead discards is informative for the projection of dead discards. As an example, Figure 8 displays a scatterplot of black sea bass recreational discards and landings for reference. The positive relationship between dead discards was also present in the commercial and recreational scup and summer flounder fisheries.

Figure 8: Scatterplot of black sea bass recreational discards and landings (2004-2018).

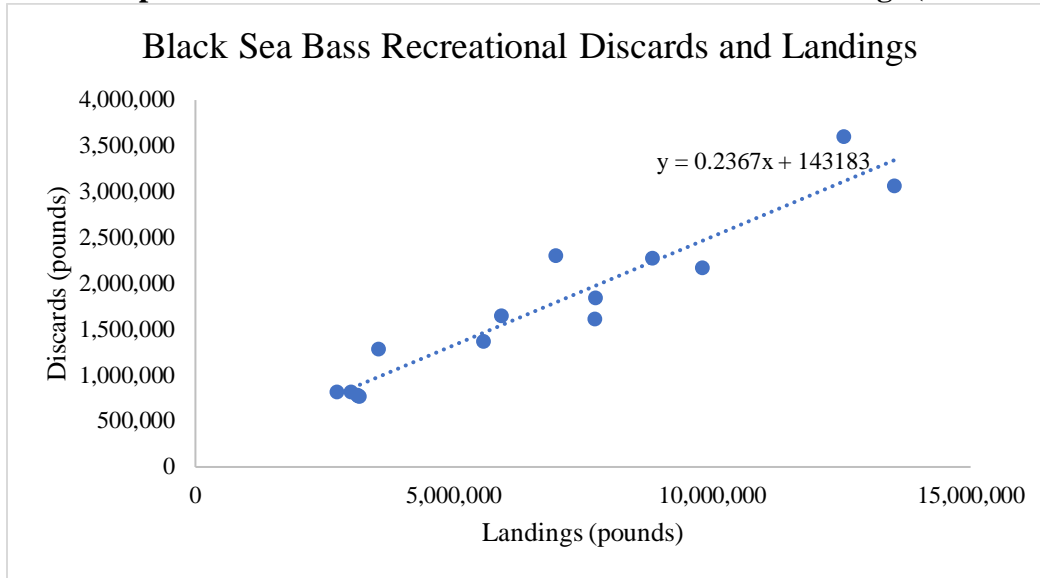

Deriving Landings Limits for Catch-based Allocations

Projecting discards for catch-based allocations relies upon simple linear regression with catch as the dependent variable and discards as the independent variable. As such, discards were regressed on catch for the years 2004-2018 for all three species by sector. While the coefficients for catch were not statistically significant at the 90% confidence interval for all species and sectors, in all instances the regression analyses revealed a positive linear relationship. The regression output provides an understanding of how discards scale with catch. By combining this understanding with an example ABC and a specific allocation share, it becomes possible to project a RHL and commercial quota for each allocation alternative.

Deriving Landings Limits for Landings-Based Allocations

Projecting landings limits for landings-based allocations also relies upon simple linear regression, but with landings as the independent variable and discards as the dependent variable. Discards were regressed on landings for the years 2004-2018 for all three species by sector. Although the coefficients for landings were not all statistically significant at the 90% the regression analyses did reveal a positive linear relationship for all three species. The use of regression analysis provides a model for how discards may potentially scale with landings. Through algebraic manipulation, it is possible to solve for the RHL and commercial quota given a specific allocation share and an example ABC.

Example RHLs and Quotas Under Allocation Alternatives

The following tables provide the example commercial quotas and RHLs for each species under each allocation alternative using the methodology described above. As previously stated, the regressions were based on landings and discards data from 2004-2018. In addition, the 2020 ABC value was used. For the status quo allocation alternatives, the actual 2020 commercial quota and RHL values are displayed for comparison.

When interpreting these tables, it may be helpful to also reference the basis for each alternative as described in more detail in Appendix B, an explanation of the implications of catch versus landings-based allocations in Appendix A, and view a comparison of recent landings trends to the projected landings limits for each allocation alternative (including status quo which is highlighted) in Section 4.2.

Table 21: Black sea bass example quotas and RHLs in millions of pounds, under an ABC of 15.07 million pounds.

Black Sea Bass							
2020 ABC: 15.07 mil lb.	CATCH-BASED			LANDINGS-BASED			
Alternative	1c-1	1c-2	1c-3	1c-4 ^a	1c-5	1c-6	1c-7
Com. allocation	32%	28%	24%	49%	45%	29%	22%
Rec. allocation	68%	72%	76%	51%	55%	71%	78%
Commercial ACL	4.82	4.22	3.62	6.98	7.32	4.69	3.47
Commercial discards	1.51	1.23	0.95	1.40	2.28	1.31	0.85
Commercial quota	3.31	2.99	2.66	5.58	5.04	3.38	2.61
Recreational ACL	10.25	10.85	11.45	8.09	7.75	10.38	11.60
Recreational discards	2.08	2.20	2.32	2.28	1.60	2.10	2.34
RHL	8.16	8.65	9.14	5.81	6.15	8.28	9.27

^a This is the no action/status quo alternative. The values shown here represent the catch and landings limits implemented in 2020, not example measures using the methodology described in this appendix.

Table 22: Scup example quotas and RHLs in millions of pounds, under an ABC of 35.77 million pounds.

Scup							
2020 ABC: 35.77 mil lb.	CATCH-BASED				LANDINGS-BASED		
Alternative	1b-1 ^a	1b-2	1b-3	1b-4	1b-5	1b-6	1b-7
Com. allocation	78%	65%	61%	59%	57%	56%	50%
Rec. allocation	22%	35%	39%	41%	43%	44%	50%
Commercial ACL	27.90	23.25	21.82	21.10	21.49	21.18	19.27
Commercial discards	5.67	6.35	5.90	5.67	4.65	4.62	4.46
Commercial quota	22.23	16.90	15.92	15.44	16.85	16.56	14.81
Recreational ACL	7.87	12.52	13.95	14.67	14.28	14.59	16.50
Recreational discards	1.36	1.48	1.58	1.62	1.57	1.59	1.70
RHL	6.51	11.04	12.37	13.04	12.71	13.01	14.81

^a This is the no action/status quo alternative. The values shown here represent the catch and landings limits implemented in 2020, not example measures using the methodology described in this appendix.

Table 23: Summer flounder example quotas and RHLs in millions of pounds, under an ABC of 25.03 million pounds.

Summer Flounder							
2020 ABC: 25.03 mil lb.	CATCH-BASED			LANDINGS-BASED			
Alternative	1a-1	1a-2	1a-3	1a-4 ^a	1a-5	1a-6	1a-7
Com. allocation	44%	43%	40%	60%	55%	45%	41%
Rec. allocation	56%	57%	60%	40%	45%	55%	59%
Commercial ACL	11.01	10.76	10.01	13.53	12.69	10.72	9.92
Commercial discards	2.22	2.19	2.10	2.00	2.49	2.33	2.26
Commercial quota	8.79	8.57	7.92	11.53	10.20	8.38	7.65
Recreational ACL	14.02	14.27	15.02	11.51	12.34	14.31	15.11
Recreational discards	3.77	3.80	3.87	3.82	3.99	4.07	4.10
RHL	10.24	10.47	11.15	7.69	8.34	10.25	11.02

^a This is the no action/status quo alternative. The values shown here represent the catch and landings limits implemented in 2020, not example measures using the methodology described in this appendix.

APPENDIX D: Acronyms and Abbreviations

ABC	Acceptable Biological Catch
ACL	Annual Catch Limit
ACT	Annual Catch Target
AM	Accountability Measure
Board	The Commission's Summer Flounder, Scup, and Black Sea Bass Management Board
Commission	Atlantic States Marine Fisheries Commission
Council	Mid-Atlantic Fishery Management Council
FMP	Fishery Management Plan
MC	Monitoring Committee
MRIP	Marine Recreational Information Program
NEFSC	Northeast Fisheries Science Center
NMFS	National Marine Fisheries Service
RHL	Recreational Harvest Limit
TAL	Total Allowable Landings